

Report Manager

Programmer's Guide and Reference

Licensed Program 2A55RM1 V2R4M0



Spooled File Distribution

Edition

Seventeenth Edition (February 2011)

This edition applies to the licensed program Report Manager (Program 2A55RM1), Version 2 Release 4 Modification 0, and to all subsequent releases and modifications until otherwise indicated in new editions. This revision makes all previous editions obsolete. Make sure you are using the proper edition for the level of the product.

This manual is available as option 1 from the RPTADM menu or in PDF format in directory /Gumbo/Proddata/2A55RM1/doc on your System i and on the web.

We welcome your comments. Send them to:

GUMBO
Software, Inc.

809 W Howe St
Seattle, WA 98119
United States of America
Phone: 206-284-5078
Email: support@gumbo.com
Web: www.gumbo.com

© Copyright Gumbo Software, Inc. 1992, 2011. All Rights Reserved.

Contents

Edition	ii
----------------------	-----------

Contents	iii
-----------------------	------------

Chapter 1 Introduction	7
-------------------------------------	----------

What's In This Chapter	7
Report Manager Features	7
Standard Product Support Features.....	9
Introduction To Report Writers	9
Introduction To Reports.....	10
Introduction To Subscriptions	12
Introduction To Report Filters	13
Introduction To Archives.....	13
Introduction To Form Types	14
Introduction To Other Concepts.....	14
Additional Features.....	15
Considerations	16
Product Positioning.....	17
Future Directions	18
Manual Conventions	18

Chapter 2 Installation	19
-------------------------------------	-----------

What's In This Chapter	19
Installing Report Manager.....	19
Verifying Report Manager Installation.....	20
API Authority Granted During Installation..	21
Library List Considerations.....	21
Release Considerations	21
New Release Testing	22
Deleting Report Manager	23
Additional Installation Information.....	23
Technical Support	23
Accessing Program Examples With Source Code.....	24
Integrating Report Manager and SpoolMail.	24
Integrating Report Manager and Spool-a- Matic.....	24
Hot Site Installation	25
Permanent Authorization Codes.....	25

Chapter 3 Quick Start Example	29
--	-----------

What's In This Chapter	29
Before You Start	29
Keying The Example	29

Chapter 4 Menu	35
-----------------------------	-----------

What's In This Chapter	35
------------------------------	----

Accessing The Menu	35
--------------------------	----

Menu Options	35
--------------------	----

Chapter 5 Set Up	37
-------------------------------	-----------

What's In This Chapter	37
Overview.....	37
Printing Separator Pages	37
Choosing A Report Library	37
Choosing Report Writers	38
Starting Report Writers	38
Managed And Unmanaged Spooled Files....	39
Creating Reports	39
Verifying Reports.....	40
Creating A Test Environment	40
Adjusting Form Type And Copies	41
Adding Subscriptions.....	42
Adding Report Filters	42
Archiving Spooled Files.....	43
Creating Form Types.....	43
Summary Of Recommendations.....	44

Chapter 6 Scenarios	47
----------------------------------	-----------

What's In This Chapter	47
Setting Up A Simple System	47
Shielding Small Printers From Large Spooled Files.....	49
Defining A Multi-Company Report	49
Insuring A Single Form Type For A Printer..	50
Delegating Distribution Maintenance.....	51
Splitting RJE Output Streams.....	52

Chapter 7 Commands	55
---------------------------------	-----------

What's In This Chapter	55
Add Report Filter (ADDRPTFTR)	56
Add Report Subscription (ADDRPTSUB).....	59
Archive Spooled File (ARCSPLF).....	67
Change Banner Definition (CHGBNRDFN) .	69
Change Form Type (CHGFRMTYP)	73
Change Report Manager Authorization (CHGRM1AUT)	74
Change Report Manager Default (CHGRM1DFT)	76
Change Report (CHGRPT)	80
Change Report Filter (CHGRPTFTR).....	90
Change Report Subscription (CHGRPTSUB)93	
Change Report Writer (CHGRPTWTR).....	101

Check Report Manager Authorization (CHKRM1AUT)	104
Copy Report (CPYRPT)	105
Copy Report Filter (CPYRPTFTR).....	106
Copy Report Subscription (CPYRPTSUB)...	108
Create Form Type (CRTFRMTYP).....	111
Create Report (CRTRPT).....	112
Create Spool Save File (CRTSPLSAVF)	122
Convert Report Release (CVTRPTRL)S)	124
Delete Form Type (DLTRMTYP).....	126
Delete Report (DLTRPT).....	127
Dump Page Index Positions (DMPPIP)	128
Display Mail Log (DSPMAILLOG)	130
Display Page Data (DSPPAGDTA)	132
Display Report Log (DSRPTLOG)	136
Display Report Selection List (DSRPTSLTL)	139
Duplicate Spooled File (DUPSPLF).....	141
End Report Writer (ENDRPTWTR)	143
Extract Form Type (EXTRMTYP).....	144
Extract Report (EXTRPT)	145
Hold Report (HLDRPT).....	147
Hold Report Subscription (HLDRPTSUB) ..	148
Hold Report Writer (HLDRPTWTR).....	151
Restart/Purge Local Mail (INZLOCAL).....	152
Merge Spooled File (MRGSPLF).....	154
Ping SMTP Mail Server (PINGMAIL).....	157
Release Report (RLSRPT).....	159
Release Report Subscription (RLSRPTSUB) ..	160
Release Report Writer (RLSRPTWTR)	163
Remove Report Filter (RMVRPTFTR).....	164
Remove Report Subscription (RMVRPTSUB)	166
Retrieve Page Data (RTVPAGDTA).....	169
Retrieve Spooled File (RTVSPLF).....	172
Start Report Writer (STRRPTWTR)	175
Verify/Set Up Local SMTP (VFYLOCAL)....	182
Verify/Set Up Mailhub Server (VFYMAILHUB)	183
Verify/Set Up Mail Router (VFYROUTER) ..	185
Work with Form Types (WRKFRMTYP)....	187
Work with Reports (WRKRPT).....	188
Work with Report Filters (WRKRPTFTR) ...	189
Work with Report Output Queue (WRKRPTOUTQ).....	191
Work with Report Spooled Files (WRKRPTSPLF)	192

Work with Report Subscriptions (WRKRPTSUB).....	196
Work with Report Writer (WRKRPTWTR) ..	200

Chapter 8 Advanced Topics 201

What's In This Chapter	201
Subscription Destinations and Parameters ..	201
Report Writer Construction Notes	203
Report Writer File Selection Processing.....	206
Report Writer Page Separator Printing.....	207
Report Writer Spooled File Limit And Writer Restart.....	207
IBM i Output Queue Selection Logic	208
Report Manager Output Queue Selection Logic	208
Report Writer Redelivery Logic.....	209
Archive Naming	209
Archive Restore Program	209
Log Purge Program	210

Chapter 9 Security..... 211

What's In This Chapter	211
API Authority Granted During Installation	211
Granting *SPLCTL Special Authority To Operators	211
Removing Authority Adoption	211
Report Writer User Profile.....	212

Chapter 10 Trouble-Shooting 213

What's In This Chapter	213
General Report Writer Trouble-Shooting....	213
Report Selection Problem Isolation Procedure	213
Miscellaneous Report Writer Symptoms And Their Causes	215
Additional Tips And Ideas.....	215
Software Installation Problems.....	216
General Mail Delivery Problems	217
MSF Specific Delivery Problems.....	220
SMTP Specific Delivery Problems.....	221
Creating a Spool Save File	222
Emailing A Spool Save File	222

Chapter 11 Mail Set Up 225

What's In This Chapter	225
Selecting The Quick Start Mail Set Up Procedure	225
Quick Start Mail Set Up - Mailhub	226
Quick Start Mail Set Up - Direct Delivery ...	227

Using The SMTP Set Up Command.....	228
Using The Mailhub Set Up Command.....	228
Manual Mail Set Up Steps You May Need To Perform.....	229
Additional Mail Set Up Resources	234
Appendix A Record Descriptions .	235
What's In This Appendix	235
Report Distribution Log Contents	235
Report Log Event Record.....	235
Report Log Distribution Record	237
Report Log Message Record.....	239
Report Filter Record	240
Report Subscription *BASIC Record	241
Report Subscription *FULL Record.....	242
Report Writer Control Record.....	244
Display Page Data Record	246
Appendix B Process Descriptions	248
What's In This Appendix	248
SMTP Verification Process.....	248
SMTP Set Up Process	249
Mailhub Verification Process	251
Mailhub Set Up Process	252
Appendix C Notices	255
Appendix D Order Form.....	256
Appendix E License Agreement ...	257

Chapter 1 Introduction

What's In This Chapter

This chapter describes the features of Report Manager. In addition it introduces the following concepts as used by Report Manager:

- Report writer
- Report
- Subscription
- Report Filter
- Archive
- Form type
- Others

Finally the chapter describes:

- Additional installable Report Manager features
- Some considerations
- Describes Report Manager's relationship to other products.
- Outlines future directions for the product.
- Describes conventions used in this manual.

Report Manager Features

Report Manager is a software utility that integrates and automates report distribution and spooled file management for IBM's IBM i - allowing you to reduce printing costs while better serving your users. Report Manager delivers output to the right place, in the right form. No more hand splitting and sorting of paper. No more programming changes or job reruns to produce additional copies. No more discarding all but a few pages. Report Manager offers a complete solution for report management. Report Manager features include:

- Extended function printer writers

Distribution of print output is accomplished by Report Manager "report writers". These are similar to IBM i printer writers but more powerful. Report writers process spooled files from output queues and support:

- Distribution of a single spooled file to multiple recipients, output queues, printers, email addresses and network IDs.
 - Conversion to an Integrated File System object (PC file).
 - Printing of spooled files collated by recipient, form type, delivery point, or report group.
 - Archiving of spooled files for offline storage, recall and reprinting.
 - Splitting of spooled files based on filter specifications.
 - Printing of customizable separators with large block letters, distribution, delivery, and bursting sequence information.
 - Printing of customizable packing slips with an index to the reports printed in a group.
 - Exit points for additional processing. Programs are included for large laser commands, microfiche output, archive save/recall, message notification among others.
- Reports

Spooled file distribution is controlled by information stored in Report Manager "reports". These contain spooled file selection and distribution specifications that direct the processing of report writers. Implemented as system objects, reports can be saved, restored and moved using ordinary IBM i commands. They can also be secured individually using IBM i security.

- Subscription based report distribution

Distribution specifications are added to reports in the form of subscriptions. Subscription features include:

- Named recipient or network user ID.
- Queues, printers, email, PC files or programs as destinations.
- Form type and copies specification.
- Page filter specification.
- Start and end dates.
- Temporary delivery (vacation) hold.
- Multiple subscriptions per recipient.
- External delivery point specification.

- Organized access to spooled files

Report Manager provides an organized way to display, print or retrieve spooled files using convenient keywords such as date, recipient or delivery point.

- Report Filtering

Reports can be filtered (split) during distribution, with only selected pages delivered to a recipient.

- Report Archiving

Report Manager can archive spooled files, allowing individual files to be recreated or saved and restored.

- Report Distribution Log

A report distribution log is maintained showing all actions and activity.

- No change to existing software

Report Manager does not require that existing software be changed in order to implement report distribution.

- Implementation Flexibility

Report Manager supports implementations ranging from separator pages for a single printer to recipient maintained subscription-based network report distribution. Report Manager can operate in a mixed environment where some spooled files are managed while others are not, even when those spooled files are mixed on a single output queue. This flexibility allows for gradual non-disruptive implementation as resources allow or as growth demands.

Report Manager provides commands that can extract report and form type information from application programs and printer files. These commands reduce the effort needed to implement Report Manager.

Standard Product Support Features

GUMBO products include a range of standard features that make them easy to use, easy to manage, and easy to live with:

- Extensive manual, both online as menu option 1 and in PDF
- Context sensitive help for every command and parameter.
- Menu that provides organized access to the product's features.
- Products are packaged as licensed programs and participates in the full range of support provided by IBM i Licensed program installation, PTF management, etc. are handled with the same commands used to manage IBM® software.
- Unlike IBM® Licensed Programs, our products are packaged to allow multiple releases to be installed at the same time, which facilitates new release testing.
- Product PTFs are available on the web at www.gumbo.com.
- Our products include a hot site friendly automatic authorization function that allows you to immediately move operations to any back up or fail over machine without contacting us for a license key or authorization code.
- We include a Check Report Manager Authorization (CHKRM1AUT) command that allows you to exercise the product's authorization algorithm and insure there are no authorization "surprises".
- An installation verification option is available on the menu. You can easily verify that the product is correctly installed.
- All (applicable) objects in our products are digitally signed allowing you to verify their integrity. Modifications that could jeopardize the security of your system are easily detected with IBM i's Check Object Integrity (CHKOBJITG) command.
- Our products are upward compatible with future releases of IBM i. You can install a new releases of IBM i without installing a new release from us.
- Our products are compatible with all IBM i security levels. We use only published interfaces.

Introduction To Report Writers

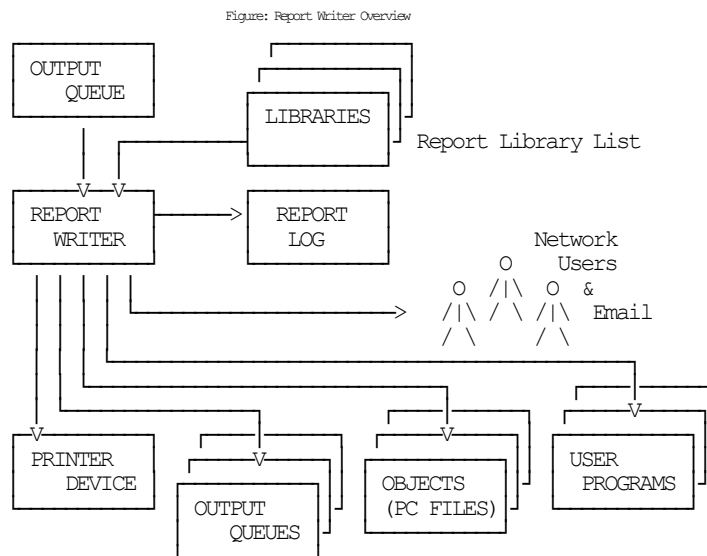

A report writer is an enhanced printer writer that is started against an output queue and processes spooled files as they become ready. Report writers provide two sets of functions. These are report distribution processing and optionally, extended printer function.

Report distribution processing consists of:

- Comparing each spooled file's attributes to the selection criteria of reports to determine a match.
- Performing distribution functions based on the report and its subscriptions. These include:
 - Adjusting copies and form type to meet current requirements.
 - Decollating (splitting) spooled files based on selection criteria specified in report filters.
 - Duplicating spooled files destined for multiple output queues.
 - Sending spooled files to network users on the local or remote systems.
 - Converting spooled files to objects (PC files).
 - Calling user process programs to perform special processing.
- Archiving spooled files for later reprinting or offline storage.
- Logging all activity to the report log.

Extended printer function consists of:

- Printing of meaningful separator pages between spooled files.
- Printing of packing slips between groups of spooled files.
- Options to print spooled files collated by form type, report group, delivery point, or recipient.

The commands for working with report writers are:

- Change Report Writer (CHGRPTWTR)
- End Report Writer (ENDRPTWTR)
- Hold Report Writer (HLDRPTWTR)
- Release Report Writer (RLSRPTWTR)
- Start Report Writer (STRRPTWTR)
- Work with Report Writer (WRKRPTWTR)

Introduction To Reports

Figure: Report Manager Reports

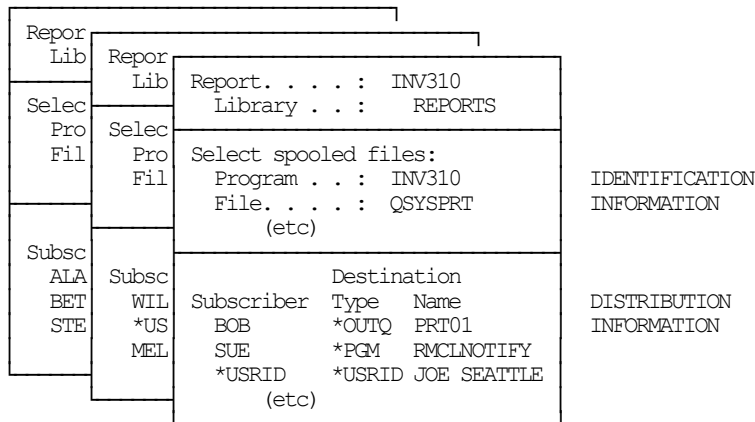

A report is a system object containing information used by Report Manager to identify and distribute related spooled files.

- The identification information includes:
 - Selection criteria which are compared to the attributes of spooled files by Report Manager to determine which individual spooled files are an edition of the report.
 - An abstract which describes the purpose and contents of a report.
 - A subject to be used when generating email.
- The distribution information includes:

- Subscriptions which specify report recipients and method of delivery.
- Report filters which specify page selection criteria for decollating.
- Specifications for printing such as defaults for form type, copies, and output queue.
- The name of a user process program to handle unique processing needs.
- The name of a library to receive archives containing the report's spooled files.
- Specifications for other processing such as delivery point, hold status, report group, transform, send format, and whether or not subscriptions are allowed.

Much of the distribution information can be specified on the report and overridden by the values specified on individual subscriptions.

Typical examples of reports include:

- Purchase Orders
- "Month End Cash Requirements Report"
- "Part No. Where Used"
- "Inventory Quantities By SKU #"
- Invoices

The commands for working with reports are:

- Change Report (CHGRPT)
- Copy Report (CPYRPT)
- Create Report (CRTRPT)
- Delete Report (DLTRPT)
- Extract Report (EXTRPT)
- Hold Report (HLDRPT)
- Release Report (RLSRPT)
- Work with Reports (WRKRPT)

Reports are implemented as user indexes. By specifying a report's name and an object type of *USRIDX, IBM i commands can be used with reports. Examples of IBM i commands for working with reports are:

- Move Object (MOV OBJ)
- Rename Object (RNMOBJ)
- Restore Object (RSTOBJ)
- Save Object (SAVOBJ)

Note: For a complete list of applicable IBM i commands display the Object Commands menu (GO CMDOBJ)

Introduction To Subscriptions

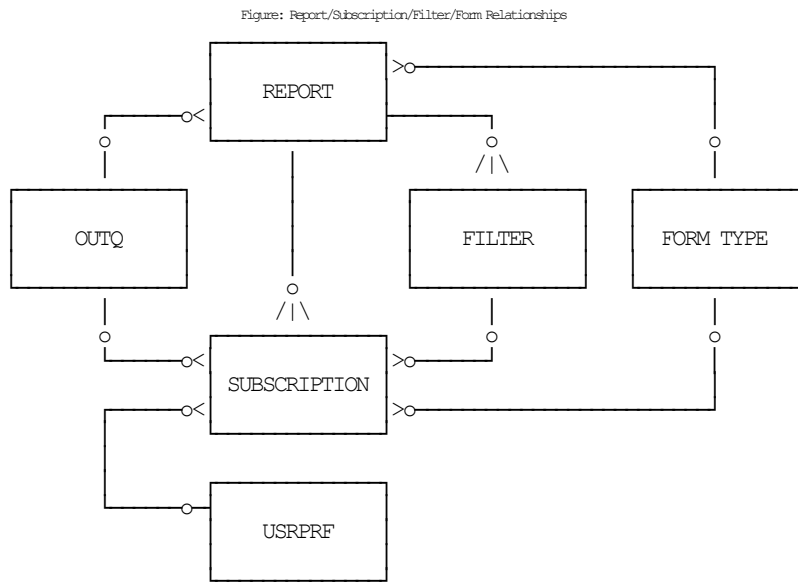

Legend:

- /|\
| or - one to one relationship
- o or > one to many relationship
- o optional relationship

A report subscription represents a request for delivery of each edition (spooled file) of a report. Typically delivery means moving a spooled file to a destination output queue for printing but can include other types of delivery:

- Delivery to an output queue.
- Delivery to a printer device.
- Delivery to a network user (Email or SNDNETSPLF).
- Delivery (conversion) to a PC file.
- Delivery to a user process program (CALL).

An individual subscription can specify only one destination.

For detailed information on specifying a destination see the Add Report Subscription (ADDRPTSUB) command and the Subscription Destinations and Parameters section of chapter 8.

A subscription also specifies details of the delivery, such as:

- Delivery point.
- Form type and copies.
- Start and end dates.
- Filter (page selection) criteria.
- Transform to perform.
- Send format.

A report subscription is added on behalf of a subscriber. A subscriber is identified in one of two ways:

- By a user name.
- By a network user name.

An individual subscription can specify only one of these.

A network user receives subscriptions on the local system or on a remote system as email or through the SNADS network. For email, subscriptions are delivered as a message with the spooled file placed in an attached file. For SNADS networks, subscriptions are placed on the output queue specified in the user profile of the network user. Network users are identified by a two part user ID or by a two part distribution list ID.

Subscription numbers uniquely identify the subscriptions of an individual subscriber to a report. Subscription numbers allow a subscriber to subscribe to a report more than once.

The commands for working with subscriptions are:

- Add Report Subscription (ADDRPTSUB)
- Change Report Subscription (CHGRPTSUB)
- Copy Report Subscription (CPYRPTSUB)
- Hold Report Subscription (HLDRPTSUB)
- Release Report Subscription (RLSRPTSUB)
- Remove Report Subscription (RMVRPTSUB)
- Work with Report Subscriptions (WRKRPTSUB)

Introduction To Report Filters

A report filter specifies test criteria for a report that are used to reduce the number of pages delivered for a subscription. After a filter has been added to a report, it may be specified on one or more subscriptions. When a report writer processes the subscription, it tests each page of the spooled file against the filter criteria to determine if the page is selected for distribution. A page is selected when the data on the page meets the criteria specified.

All selected pages are placed in a new spooled file. If the user data (USRDTA) attribute of the original spooled file is blank, the new spooled file has the filter's name for user data.

The commands for working with report filters are:

- Add Report Filter (ADDRPTFTR)
- Change Report Filter (CHGRPTFTR)
- Copy Report Filter (CPYRPTFTR)
- Remove Report Filter (RMVRPTFTR)
- Work with Report Filters (WRKRPTFTR)

Introduction To Archives

An archive is a user space (system object type *USRSPC) which contains all the information required to recreate a spooled file. A spooled file in archive form can be saved and restored in the same ways as other system objects. Archives can be created by:

- Using the Archive Spooled File (ARCSPLF) command with individual spooled files.
- A report writer for each spooled file processed.
- A report writer for the spooled files of specific reports.

Archives can be given a name when created using the Archive Spooled File (ARCSPLF) command. Alternately, the command can generate a unique archive name based on the spooled file being archived. Report writers always create archives with generated names.

The "Library to receive archive" (ARCLIB) parameter of the report and report writer commands govern report writers' automatic production of archives. If a library name is specified, an archive is created. If a library is specified on both the report and the report writer, the report takes precedence.

Additional commands for working with spooled file archives are:

- Archive Spooled File (ARCSPLF)

- Retrieve Spooled File (RTVSPLF)
- Work with Report Spooled Files (WRKRPTSPLF)

Archives are user spaces. By specifying an archive's name and an object type of *USRSPC, IBM i commands can be used with archives. Examples of IBM i commands for working with archives are:

- Move Object (MOV OBJ)
- Rename Object (RNMOBJ)
- Restore Object (RSTOBJ)
- Save Object (SAVOBJ)

Note: For a complete list of applicable IBM i commands display the Object Commands menu (GO CMDOBJ)

Introduction To Form Types

A form type identifies a particular kind of paper, preprinted form or other material that is used by a printer device. Typical examples of forms used in printing are:

- 14 7/8" x 11" 15 pound continuous green bar 1 part
- 9 1/2" x 11" continuous green bar 3 part carbonless
- 8 1/2" x 11" bond 20 pound cut sheet
- continuous preprinted checks
- 3 1/2" x 15/16" continuous 2 across pressure sensitive labels

The commands for working with form types are:

- Change Form Type (CHGFRMTYP)
- Create Form Type (CRTFRMTYP)
- Delete Form Type (DLTFRMTYP)
- Extract Form Type (EXTFRMTYP)
- Work with Form Types (WRKFRMTYP)

Introduction To Other Concepts

Additional Report Manager concepts include:

- Delivery point
- Report group
- Report library list
- Report distribution log
- Separator print program

Delivery point

A delivery point is a named external destination. Delivery points refine and further subdivide the destination of a report or a subscription beyond what is possible by designating output queue alone. Delivery points can have any name and any meaning desired. For an installation with a large central print facility, delivery points might be the names of bins the print operator places the printed output into. At another installation, delivery points might be the office, room, floor or building numbers to which the printed output is delivered. A delivery point can be specified on reports and on subscriptions with subscriptions having precedence.

Report group

A report group is a collection of related or similar reports. Report groups provide a means of segregating printed output. Report groups can have any name and any meaning desired. For an installation with many applications,

report groups might be the name of the application the report belongs to such as "INVENTORY" or "ACCOUNTING". At another installation, report groups might be the name of the process that produces the report such as "MONTHEND" or "NIGHTLY".

Report library list

A report library list is a list of library names used to locate reports. A report writer compares the attributes of a spooled file to the selection criteria contained in reports to determine how a spooled file should be distributed. The comparison is made with reports in the first library in the report library list. If no match is found, the report writer compares the attributes to reports in the second library in the library list. This process is continued until a match is found or the report library list is exhausted.

Within a library, reports are compared in order by their selection sequence. Reports that specify a lower sequence number are compared before reports that specify a higher sequence number.

Note: When ***JOB**, ***ALL**, ***ALLUSR** or ***CURRENT** is specified for the report library list, all of the reports in the specified libraries are located and considered as one group for comparison. All reports in the libraries with selection sequence 1 will be considered before any report with selection sequence 2.

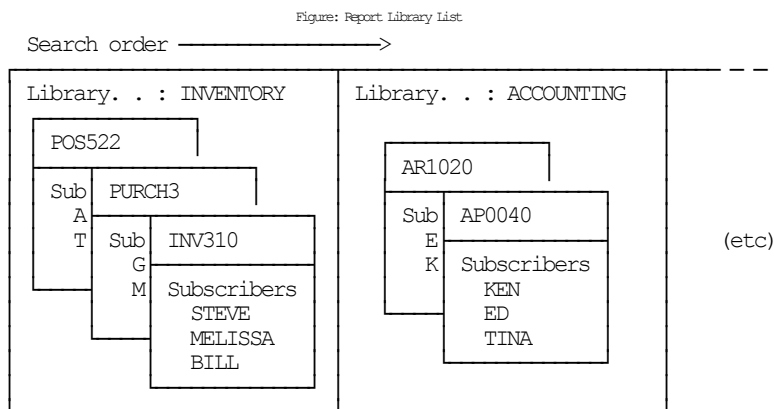

Report distribution log

The report distribution log contains information about the work performed by report writers. The log contains entries for each spooled file processed, each delivery made, and any errors or warnings encountered.

Separator print program

A separator program is a program that is given control by a report writer to generate separator pages to be printed between spooled files.

The ***BANNER** separator print program is supplied by Report Manager. It creates separators with large block letter print and provides subscription information when available.

The ***PACKSLIP** separator print program is supplied by Report Manager. It creates a table of contents style listing of the spooled files printed in a package or bundle. In addition, the ***PACKSLIP** generates separators between individual spooled files based on the **FILESEP** parameter specified for the report writer. If the **FILESEP** parameter is not zero, separators between individual spooled files are created using the ***BANNER** separator program.

A Banner definition is a system object used by the Report Manager supplied separator programs ***BANNER** and ***PACKSLIP**. A banner definition describes the contents and appearance of separator pages printed between spooled files.

Additional Features

Report Manager provides several additional functions and features as installable options with source code. These features include:

Archive Output Queue Command

The Archive Output Queue (ARCOUTQ) command uses a Report Manager report writer to archive all spooled files in an output queue to tape or disk for later retrieval.

Archive Offline Storage Manager

The archive offline storage manager moves archives to tape or save files and recalls them when needed to recreate spooled files.

Create Computer Output Microfiche Tape

The create computer output microfiche tape feature allows a report writer to deliver spooled files to tape in a format suitable for output to microfiche.

Day of the Week Delivery Scheduling

The day of the week delivery scheduling feature allows a report writer to selectively deliver a subscription depending on the day of the week.

Laser Commands

The laser commands feature allows a report writer to send commands to large laser printers that process a printer command language such as Xerox Laser Printing System's PDL/DJDE or Siemens Nixdorf Electronic Printing System's SIEPRT/VSE.

Optical Storage Interface Programs

The optical storage interface feature allows a report writer to deliver spooled files to optical storage devices.

See the source file RMSOURCE for a complete list of options, additional details and installation instructions.

Considerations

Report Manager is designed to "work the way you would expect it to". Wherever possible, IBM i conventions are used or guide the implementation of the software. However, 5 items work in a way that may not be expected, or deserve consideration when using Report Manager. These are held output queue processing, system restart after abnormal termination, spooled file filtering capabilities, spooled file merging capabilities, and a report writer's report limit.

The way in which a report writer responds when the output queue it is processing is held is different than the way an IBM i printer writer responds. Each time that a report writer begins processing a spooled file, it first checks to see if the output queue has been held. If it has, the writer sends an inquiry message to the operator. Based on the operator's response, the writer will ignore the fact the output queue has been held or will end the report writer entirely. By not responding to the inquiry message the operator can in effect suspend processing of the report writer.

Report Manager software is designed to tolerate and automatically recover from abnormal terminations in the system. However, at several points in the code, control is passed to the operating system to duplicate spooled files (this usually occurs when the destination is more than one output queue). If the system ends abnormally, Report Manager assumes that the duplication did not finish and that the operation should be repeated in order to recover. If the operating system actually did complete the duplication and the abnormal termination occurred before control was returned to Report Manager, extra copies of the spooled file will be duplicated when the system is restarted.

Report Manager can create new spooled files from selected pages of a larger spooled file. This function, sometimes known as decollating, bursting, or bundling, is specified using report filters. IBM i supports a wide variety of printer data streams: *SCS, *IPDS, *AFPDS, *AFPDSLNE, *USERASCII, etc. Report Manager's filtering capability, its ability to read, interpret and write print data streams, is limited to *SCS, *IPDS and *AFPDS. If Report Manager encounters a spooled file that it can not filter, a complete unfiltered copy is delivered and a message is entered in the report distribution log. See the Set Up chapter for information on testing Report Manager's capabilities against specific spooled files.

Report Manager can create new spooled files by merging the pages of several spooled files. This function is provided by the Merge Spooled File (MRGSPLF) command. IBM i supports a wide variety of printer data streams: *SCS, *IPDS, *AFPDS, *AFPDSLNE, *USERASCII, etc. Report Manager's merging capability, its ability to read,

interpret and write print data streams, is limited to *SCS, *IPDS, and *AFPDS. All spooled files to be merged must have the same data stream type. In addition, there are limitations to Report Manager's abilities to merge spooled files particularly when the spooled files have dissimilar form sizes. The Merge Spooled File (MRGSPLF) command may not be able to process particular spooled files and may not be suitable for your requirements. You should test the command against your application to determine if it works correctly.

A single report writer has a limit of 59,493 reports that it can consider when processing spooled files. For the typical customer this is more than adequate and all reports are placed in a single library which is specified on the RPTLIBL() parameter when each writer is started. For large installations this may not be adequate in which case reports should be segregated into different report libraries based on some convenient separation such as application or client or company. Then a report writer can be started for each application or client or company specifying the report library specific to each on the RPTLIBL() parameter.

Product Positioning

Gumbo Software, Inc. has several IBM i based products:

Number	Licensed Program
2A55RM1	Report Manager - Automates report distribution, bursting and spooled file management
2A55SM1	SpoolMail - Converts IBM i spooled files into industry standard file formats and sends the resulting PC files to any email recipient
2A55SAM	Spool-a-Matic - Converts IBM i spooled files into industry standard file formats and places the resulting PC files in the Integrated File System
2A55XL1	Excel-erator - Converts database files into spreadsheets placing the resulting PC files in the Integrated File System or sends the resulting PC files to any email recipient
2A55DCR	Dicer - Merges/sorts/splits/duplicates spooled files
2A55RDA	Report Designer - Edits DDS, RPG and ILE/RPG print specifications
2A55SM2	Gumbo Mail - Sends email from your applications

There is some overlap between and unique function within the products. Choose the product or combination of products that provide the function you need:

Function	Product						
	RM1	SM1	SAM	XL1	DCR	RDA	SM2
Primary input to product	SPL	SPL	SPL	DBF	SPL	SRC	IFS
Primary output from product	SPL	EML	IFS	I/E	SPL	SRC	EML
Monitor output queues for work	YES	YES	YES	-	-	-	-
Spooled file distribution	YES	-	-	-	-	-	-
Burst (split) spooled files	YES	YES	YES	-	YES	-	-
Merge/sort/duplicate spooled files	YES	-	-	-	YES	-	-
Convert spool to TXT PC file	YES	YES	YES	-	-	-	-
Convert spool to PDF/RTF/etc. PC file	-	YES	YES	-	-	-	-
Convert DB file to spreadsheet	-	-	-	YES	-	-	-
Email PC file as attachment	YES	YES	-	YES	-	-	YES
Write PC file to Integrated File System	YES	-	YES	YES	-	-	-
Set up IBM i SMTP & mailhub	YES	YES	-	YES	-	-	YES
Edit DDS, RPG, ILE/RPG source code	-	-	-	-	-	YES	-
Where: DBF = Database file EML = Email IFS = PC file in the Integrated File System I/E = Both IFS and EML SPL = Spooled file SRC = Source code							

Future Directions

Future releases of Report Manager will include enhanced functionality based on customer feedback. Additionally, enhancements are often added to a current release by Program Temporary Fix (PTF).

Contact **GUMBO** to suggest additional enhancements.

Manual Conventions

A note on conventions used in this manual. In several places, instructions for entering commands are given. When the command is intended to be run from a PC command prompt, it is flagged by `[PC]`. When the command is intended to be run from an IBM i command line, it is flagged by `[i]`, or is not flagged at all. `[Enter]` denotes the enter key.

Chapter 2 Installation

What's In This Chapter

This chapter describes

- How to install Report Manager.
- How to verify that Report Manager is installed correctly.
- API authority granted during installation
- How to include the RPTMGR library in a job's library list.
- How to determine release dependencies.
- How to test a new release while leaving the old in production.
- How to remove Report Manager from the system.
- How to find additional installation information.
- How to contact technical support.
- How to access program examples with source code.
- How to integrate Report Manager and SpoolMail.
- How to integrate Report Manager and Spool-a-Matic.
- Hot site installation.
- Permanent Authorization Codes.

Installing Report Manager

Follow these instructions to install Report Manager V2R4M0 on your System i:

Prepare

If you are upgrading a previous release (if Report Manager is currently installed on your System i) perform these steps before installing the software:

1. Read the Enhancement Summary to determine if any changes affect your installation.
2. Insure that the product is not in use, as the installation process must clear the product's library. This will fail if objects such as menus are in use. If the installation fails, the previous release will be restored.

Install

Note: If you have downloaded this software from the web, instructions specific to installing from the download can be found in the file "readme.htm" which was included.

1. Sign on to the system as the security officer (QSECOFR).
2. Verify that your machine is at IBM i V6R1M0 or later by running:

```
DSPDTAARA DTAARA (QGPL/QSS1MRI)
```

Note: If you are running a version of IBM i earlier than V6R1M0 you cannot install Report Manager V2R4M0 on your machine. You must install an earlier version of Report Manager or upgrade the operating system.

3. Verify that user domain objects are allowed in the libraries RPTMGR and QSRV, by running:

```
WRKSYSVAL SYSVAL (QALWUSRDMN)
```

Take option 5 to display the value. If the value is not *ALL, use option 2 to add libraries RPTMGR and QSRV to the list of libraries where user domain objects are allowed.

Note: QSRV is required to correctly process PTFs when they are loaded and applied.

4. Insure that IBM i will be able to verify the signatures that we apply to our product's objects by installing our Signing Certificate and Root CA Certificate using Digital Certificate Manager. Alternately, insure that signature verification will not prevent the restore operation by running:

```
WRKSYSVAL SYSVAL(QVFYOBJRST)
```

Take option 5 to display the value. If the value is 3 or higher, use option 2 to temporarily change the value to 1.

5. Mount the distribution media in the appropriate device.
6. Submit the Restore Licensed Program (RSTLICPGM) command to batch:

```
RSTLICPGM LICPGM(2A55RM1) DEV(device-name) LNG(2924)
```

Note: Where "device-name" is the device the media was mounted on and is usually OPT01.

Note: During the restore operation, the system operator message queue may receive inquiry message CPA3DE4 "Directory not registered. (C G)". Unless you are using a directory naming convention similar to ours (that is the directory specified in the CPA3DE4's second level text is unrelated to our software), you can safely respond with a "G" to reestablish the relationship between the directory and the product. Typically, the message will occur three times.

Finish

When the RSTLICPGM command completes, library RPTMGR and directory '/Gumbo/ProdData/2A55RM1' contain the new software. To complete the installation:

1. If you have an Authorization letter with your permanent authorization code, enter it now.

Note: Report Manager automatically grants 30 days usage for new installs or 90 days usage for release upgrades.

2. Determine which PTFs were included on the media by entering the following command:

```
DSPPTF LICPGM(2A55RM1)
```

3. Visit www.gumbo.com to determine if newer PTFs are available. If so, download and install them. The bottom of our PTF web page also includes a listing of any IBM PTFs that affect the product.

Note: **GUMBO** recommends downloading the current cumulative PTF package from www.gumbo.com after installing the software.

4. You can access the Report Manager menu by entering the following command:

```
GO MENU(RPTMGR/RPTADM)
```

Verifying Report Manager Installation

You can verify that Report Manager has been correctly installed by running the Check Product Option (CHKPRDOPT) command:

```
CHKPRDOPT PRDID(2A55RM1) RLS(V2R4M0) CHKSIG(*NONE)
```

Note: If you have installed our digital certificates, specify CHKSIG(*ALL) instead of CHKSIG(*NONE) and digital signatures will be checked.

If the message 'No errors detected by CHKPRDOPT.' is displayed on the bottom of your display when the command finishes, Report Manager is installed correctly.

If the message is not displayed, check your job log messages or see the Recovery Procedures in the *Software Installation Problems* section of the *Trouble-Shooting* chapter of this manual.

API Authority Granted During Installation

The first time Report Manager is installed on a system, public authority *USE is granted to the IBM i supplied spooling APIs. These are QSPOPNSP, QSPCRTSP, QSPGETSP, QSPPUTSP and QSPCLOSP. The APIs are used by Report Manager to open, create, write, read and close spooled files. This is required to perform the product's functions.

Security restrictions and authority requirements pertaining to spooled files and output queues remain in effect and are enforced by IBM i during use of the APIs. However, if you are operating a highly secured environment you may wish to review and revise the authority granted during installation.

No authority is granted during installation if Report Manager exists on the system. This prevents new releases from altering changes made after the initial installation.

Library List Considerations

Library RPTMGR must be in the library list of jobs using Report Manager commands, or the commands must be qualified with library RPTMGR. Depending on your installation and intended use, you can choose to:

- Add library RPTMGR to the system library list. This insures every job in the system has access to Report Manager commands. However, this introduces problems with installing new releases and is not recommended.
- Add library RPTMGR to the initial library list parameter of job descriptions controlling jobs that will use Report Manager commands. (recommended)
- Run an ADDLIBLE RPTMGR command in individual threads requiring Report Manager commands.
- Qualify the command names on each use:

```
RPTMGR/CHGRM1DFT
```

Library RPTMGR will be temporarily added to the product portion of the current thread's library list.

Determine the best method for your installation and perform any changes required.

Note: Report Manager submits jobs when a report writer is started. The library list of these jobs is contained in job description RMRPTWTR. Usually the supplied library list works correctly but in some cases it may require modification. For example if RPTMGR, QTEMP or QGPL are in the system library list they must be removed from job description RMRPTWTR. Use the Change Job Description (CHGJOB) command to make modifications to job description RMRPTWTR.

Release Considerations

Report Manager operates under IBM i V6R1M0 or higher. Releases occur on a different schedule than IBM releases. Once Report Manager is installed, the following considerations apply:

- A new release of IBM i may be installed without installing a new release of Report Manager.

Report Manager uses only published or IBM sanctioned interfaces and is upward compatible with all releases of IBM i. The Report Manager authorization code does not change.

- A new release of Report Manager may be installed without installing a new release of IBM i.

Any change in the requirements for operating system release level will be noted in the documentation accompanying the Report Manager release. The new authorization code must be entered.

- A new release of Report Manager may be installed over any prior release of Report Manager.

You can skip "missed" releases.

- More than one release of Report Manager may be installed on a system at one time.

By restoring Report Manager to a library other than RPTMGR, a new release can be installed for testing while the old release remains in production. Any release-to-release considerations that may apply will be noted in the documentation accompanying the new release. Additional operational considerations may apply. For more information on renaming a library during licensed program installation, see the Restore Licensed Program (RSTLICPGM) command and the New Release Testing section of this chapter.

- When a new release of Report Manager is installed in the same library as an old release the following processing is performed in order to preserve data and Report Manager authorization information:
 1. The Report Manager library is saved to QGPL/RM1VxRyMz. Where VxRyMz is the old release.
 2. Product objects that contain default settings and operational information are copied to library QTEMP.
 3. The Report Manager library is cleared.
 4. Report Manager is restored.
 5. Default settings and operational information are copied back to the product objects.
 6. All objects duplicated to QTEMP are deleted.
 7. Save file QGPL/RM1VxRyMz is deleted.

Note: **GUMBO** recommends making a backup of the old release before installing a new release of Report Manager.

The following operational items are preserved during new release installation.

- Form type file (RMFRM).
- Report distribution log files (RMDST, RMEVT and RMMSG).
- Banner definitions.
- Writer spaces.
- The report writer job description (RMRPTWTR).

New Release Testing

Unlike IBM licensed programs, **GUMBO** licensed programs are packaged in a way that allows multiple release to be installed on your System i at the same time. This feature allows you to test a new release while the old release remains in production.

The key to new release testing are the LIB() and CODHOMEDIR() parameters of IBM i's Restore License Program (RSTLICPGM) command which allow you to restore the product to a library name and directory different from those used during packaging.

To test a new release, follow this procedure:

1. Review the Enhancement Summary for any release-to-release considerations that could affect your installation.

2. Install the new release in library RM1V2R4M0 and directory '/Gumbo/ProdData/2A55RM1V2R4M0':

```
RSTLICPGM LICPGM(2A55RM1) DEV(device-name) LNG(2924)
LIB(RM1V2R4M0) REPLACERLS(*NO)
CODHOMEDIR('/Gumbo/ProdData/2A55RM1V2R4M0')
```

Where device-name is the device the media was mounted on.

3. Perform your new release testing.
4. When testing is complete, you must delete the new release.

```
DLTLICPGM LICPGM(2A55RM1) RLS(V2R4M0) OPTION(*ALL)
```

Note: Do not delete nor rename libraries and directories to move the new release into production. Doing so will corrupt the license program information kept internally by IBM i. If this has already occurred, see the Software Installation Problems section of the *Trouble-Shooting* chapter of this manual.

5. Follow the installation instructions to place the new release into production.

Deleting Report Manager

Follow these instructions to remove Report Manager from your System i:

1. Sign on to the system as the security officer (QSECOFR).
2. Delete the Report Manager library by using the Delete Licensed Program (DLTLICPGM) command:

```
DLTLICPGM LICPGM(2A55RM1) OPTION(*ALL)
```

These instructions delete an otherwise healthy installation of Report Manager. If the installation has been damaged, follow the instructions for Installation Fails in the *Software Installation Problems* section of the *Trouble-Shooting* chapter of this manual.

Additional Installation Information

Additional detailed installation information and instructions can be found in *IBM i and related software > PDF file... > Installing, upgrading, or deleting IBM i and related software SC41-5120* topic in the IBM i Information Center at <http://publib.boulder.ibm.com/series/>.

Technical Support

If you encounter a problem with Report Manager you should:

- Review the information in Chapter 10 Trouble Shooting for a description of and solution to common problems.
- Load and apply the current cumulative PTF package for the software. You can obtain the current package by visiting the web site listed below.

If the problem remains unresolved, contact:

GUMBO
Software, Inc.

809 W Howe St
Seattle, WA 98119
United States of America
Phone: 206-284-5078
Email: support@gumbo.com
Web: www.gumbo.com

Accessing Program Examples With Source Code

Source code for several example programs is contained in file RMSOURCE in library RPTMGR. The examples show how to implement commonly required additional function such as creating microfiche or driving large laser printers. To access the source code and related documentation, enter the following command:

```
WRKMBRPDM FILE (RPTMGR/RMSOURCE)
```

The file contains programming source code for your consideration. The examples have not been thoroughly tested under all conditions. **GUMBO** makes no warranty either expressed or implied with respect to the source code's merchantability or fitness for any particular purpose. The source code is provided on an "AS IS" basis.

If you decide to use the code you should copy the source members to another library. The example may not be included in or may be changed in a future release of Report Manager.

Integrating Report Manager and SpoolMail

Report Manager is a product that offers extensive spooled file manipulation capabilities, including the ability to deliver spooled files as email. The email delivery is limited however to plain ASCII text attachments and does not include the extensive conversion capabilities offered by SpoolMail.

SpoolMail is a product that offers extensive spooled file emailing capabilities, but does not provide spooled file splitting, and other capabilities offered by Report Manager.

To make the capabilities of SpoolMail available for use with Report Manager perform the following step:

1. Change the Report Manager job description RMRPTWTR to include library SPOOLMAIL on the Initial library list (INLLIBL) parameter. For example, if you are using the job description as shipped with Report Manager, run the following command:

```
CHGJOB JOB (RPTMGR/RMRPTWTR)  
        INLLIBL (RPTMGR QTEMP QGPL SPOOLMAIL)
```

2. Add subscriptions to the reports that should email spooled files using SpoolMail. For example, to email PC files as Portable Document Format from report INV310 to RMT1 SYS1, run the following command:

```
ADDRPTSUB RPT (REPORTS/INV310) USER (*USRID)  
          USRID (RMT1 SYS1) OUTQ (*NONE)  
          SNDFMT (*EMAIL) TRANSFORM (*PDFLETTER)
```

Integrating Report Manager and Spool-a-Matic

Report Manager is a product that offers extensive spooled file manipulation capabilities, including the ability to convert spooled files into PC File. The conversion is limited however to plain ASCII text and does not include the extensive conversion capabilities offered by Spool-a-Matic.

Spool-a-Matic is a product that offers extensive spooled file conversion capabilities, but does not provide spooled file splitting, and other capabilities offered by Report Manager.

To make the capabilities of Spool-a-Matic available for use with Report Manager perform the following steps:

1. Change the Report Manager job description RMRPTWTR to include library SPLAMATIC on the Initial library list (INLLIBL) parameter. For example, if you are using the job description as shipped with Report Manager, run the following command:

```
CHGJOB JOB (RPTMGR/RMRPTWTR)
      INLLIBL (RPTMGR QTEMP QGPL SPLAMATIC)
```

2. Add subscriptions to the reports that should create PC files using Spool-a-Matic. For example, to generate PC files as Portable Document Format from report INV310, run the following command:

```
ADDRPTSUB RPT (REPORTS/INV310)
          OUTQ (*NONE) TRANSFORM (*PDFLETTER)
          TOOBJ ('/MYDIRECTORY/INV310.PDF')
```

Hot Site Installation

In the event of a catastrophic system failure, an otherwise properly licensed and authorized copy of our product may be copied to a back up or fail over machine. The product's authorization algorithm will detect that the software is operating on a machine serial number different than the licensed and authorized serial number and automatically create and install a 30-day temporary authorization code for the back up or fail over machine. You do not need to contact Gumbo Software, Inc. in the event of an emergency.

An otherwise properly licensed and authorized copy of this product may be transferred to a back up or fail over machine for the purpose of testing your emergency recovery procedures and the product's automatic temporary authorization function.

The correct sequence of steps is as follows:

1. Install the software and enter the permanent authorization code on your production machine.
2. Save the software from your production machine using the Save Licensed Program (SAVLICPGM) command. This creates an authorized copy, save it with your back ups.
3. When restoring to the back up or fail over machine you must first insure that any previous copies have been deleted. To delete a previous copy use the Delete Licensed Program (DLTLICPGM) command.
4. Restore the authorized copy to the back up or fail over machine using the Restore License Program (RSTLICPGM) command.
5. Confirm that the authorized copy was correctly restored by running the Check Product Option (CHKPRDOPT) command.
6. The first time the software is used on the back up or fail over machine the product's authorization algorithm will create and install a temporary authorization code running for 30 days. This allows you install the authorized copy in advance of a disaster.

Permanent Authorization Codes

When you purchase a product from us, or when we send you a new release of a product, you receive a permanent authorization code. Here we describe how to determine the information you must give us in order to receive a permanent authorization code and how to determine if the permanent authorization code you have received is correct for your installation.

The overwhelming majority of licenses purchased from us are **System Wide Licenses**. The other possibility, a **Partition Only License**, is described at the end of this section. For a System Wide License, permanent authorization codes are specific to a **Serial Number**, a **Processor Group**, and our product's **Release**. For a Partition Only License, permanent authorization codes are specific to a **Serial Number**, a **Partition ID Number**, the partition's **Maximum Processor Capacity**, and our product's **Release**.

In all cases, our permanent authorization codes are specific to a release of our product. The release of IBM i never makes a difference. To determine the release of our product installed on your System i, run:

DSPPTF LICPGM(2A55RM1)

Where the possible LICPGM numbers are:

Number	Licensed Program
2A55RM1	Report Manager - Automates report distribution, bursting and spooled file management
2A55SM1	SpoolMail - Converts IBM i spooled files into industry standard file formats and sends the resulting PC files to any email recipient
2A55SAM	Spool-a-Matic - Converts IBM i spooled files into industry standard file formats and places the resulting PC files in the Integrated File System
2A55XL1	Excel-erator - Converts database files into spreadsheets placing the resulting PC files in the Integrated File System or sends the resulting PC files to any email recipient
2A55DCR	Dicer - Merges/sorts/splits/duplicates spooled files
2A55RDA	Report Designer - Edits DDS, RPG and ILE/RPG print specifications
2A55SM2	Gumbo Mail - Sends email from your applications

The 5th line of the panel shows the release you are running. It is V2R4M0 in this example.

```
Display PTF Status
System: GUMBO4
Product ID . . . . . : 2A55RM1
IPL source . . . . . : ##MACH#A
Release . . . . . : V2R4M0

Type options, press Enter.
 5=Display PTF details 6=Print cover letter 8=Display cover letter

PTF
Opt ID      Status          IPL
              Action

(No PTFs found.)

Bottom
F3=Exit F11=Display alternate view F17=Position to F12=Cancel
```

Note: It is possible that more than one release of a product is installed. To check, press Enter. If you are returned to the command line, only one release is installed.

All of our permanent authorization codes are serial number dependent. For a System Wide License they are also Processor Group dependent. To determine your system's serial number and processor group, run:

WRKLICINF

Lines 3 and 4 of the resulting panel show the serial number and processor group of your system.

```

Work with License Information
                                GUMBO4
                                04/06/10 18:08:32

System serial number . . . . . : 1234567
Processor group . . . . . : P10

Type options, press Enter.
  1=Add license key  2=Change  5=Display detail  6=Print detail
  8=Work with license users  ...

License
Opt  Product  Term  Feature  Description
---  ---
5761SS1 V6R1M0 5050  IBM i
5761SS1 V6      5051  IBM i
5761SS1 V6R1M0 5103  Media and Storage Extensions
5761SS1 V6R1M0 5112  PSF 1-45 IPM Printer Support
5761SS1 V6R1M0 5113  PSF 1-100 IPM Printer Support
5761SS1 V6R1M0 5114  PSF Any Speed Printer Support
5761SS1 V6R1M0 5116  HA Switchable Resources

More...

Parameters or command
====>
F3=Exit      F5=Refresh  F11=Display Usage Information  F12=Cancel
F17=Position to  F23=More options
(C) COPYRIGHT IBM CORP. 1980, 2007.

```

For a Partition Only License, permanent authorization codes depend on the Partition ID Number and maximum processor capacity. To determine the number and processor capacity of partitions on your system:

1. Start system service tools by running:

```
STRSST
```

2. After entering a Service tools user ID and Service tools password, select the option to Work with system partitions.
3. Select the option to Display partition information.
4. Select the option to Display partition processing configuration.
5. Note the Partition ID Number and Total Processor Maximum.

```

Display Partition Processing Configuration
                                System:  GUMBO4

Number of system processors . . . . . : 2
Number of available system processors . . . . . : 0
Size of system main storage (MB) . . . . . : 4096
Size of available system main storage (MB) . . . . . : 0
Interactive feature available . . . . . : 0 %

Partition
Identifier  Name      -----Total Processors-----
           Current / Pending  Minimum / Maximum
  0        PRIMARY      1 / 1      1 / 1
  1        SECONDARY    1 / 1      1 / 1

F3=Exit  F5=Refresh  F6=Print      F10=Main storage
F11=Display allocated I/O resources  F12=Cancel

```

Note: A Partition only license is not valid for a machine with only one partition.

Note: Our product's algorithm checks the authorization against the Total Processors Current value. If the maximum configured is larger than the license, the algorithm will grant usage as long as the current configured is within the license's limit, and will issue a warning.

Chapter 3 Quick Start Example

What's In This Chapter

This chapter demonstrates the features of Report Manager by taking you through the steps of a simple "Hello world!" example. The chapter describes steps you must take before starting the example, and the commands you key to complete the example. The example starts a report writer, extracts a report from the supplied sample program and adds subscriptions to it.

Before You Start

The Quick Start Example can be completed from any command line.

The example requires the use of a printer device. Locate a printer device that is convenient and available for use. If a writer is using the printer device, end it by entering the following command:

```
ENDWTR  WTR(my_device)
```

Note: Throughout the example **my_device** will be used as the printer device name. Substitute the actual name of the printer device you are using in place of **my_device**. An example of an actual printer device name is **PRT01**.

The example expects that there are no spooled files on the output queue that are ready to print. Display the contents of the output queue and hold all existing spooled files that are ready to print:

```
WRKOUTQ  OUTQ(QUSRSYS/my_device)
```

Insure that the output queue has not been held by entering the following command:

```
RLSOUTQ  OUTQ(QUSRSYS/my_device)
```

The example requires use of a library in which to store the object that is created. Determine the name of a library that can be used.

Note: Throughout the example **my_library** will be used as the library name. Substitute the actual name of the library you are using in place of **my_library**. An example of an actual library name is **QGPL**.

The supplied sample program **RMHELLO** prints a single page each time it is called. Direct its output to **my_device** by entering the following command:

```
CHGJOB  OUTQ(QUSRSYS/my_device)
```

Keying The Example

Add the Report Manager library to your job's library list:

```
ADDLIBLE  LIB(RPTMGR) POSITION(*LAST)
```

Display the Report Manager Admin menu:

```
GO  MENU(RPTADM)
```

From the command line start a report writer for the printer device:

```
STRRPTWTR  DEV(my_device) MSGQ(*REQUESTER) RPTLIBL(my_library)
```

Specifying ***REQUESTER** as the message queue insures that messages related to the writer will be sent to you. Specifying **my_library** as the report library list allows the writer to locate the sample report created later.

Note: During the Report Manager demonstration period a message with the expiration date is sent to a report writer's message queue each time the writer is started.

The report writer detects that there are as yet no reports in **my_library** and sends an inquiry message to confirm that this is intended. Display the inquiry message and respond by entering **i** and pressing enter:

```
DSPMSG
```

Figure: Inquiry Message From Report Writer

```

Display Messages
Queue . . . . . : QPGMR           System: GUMBO
Library . . . . : QUSRSYS        Program . . . . : *DSEMSG
Severity . . . . : 00            Delivery . . . . : *NOTIFY

Type reply (if required), press Enter.
Report Manager demonstration period will end 2011/05/01.
Report library list does not contain reports. (C I)
Reply . . .
Waiting for reply to message on message queue QPGMR.

F3=Exit          F11=Remove a message      F12=Cancel
F13=Remove all   F16=Remove all except unanswered  F24=More keys
  
```

Call the supplied sample program to create a one page spooled file:

```
CALL PGM(RMHHELLO)
```

The report writer generates a one page large block letter separator and then prints the single page with the words "Hello world!" similar to the following:

Figure: Separator Page And RMHELLO Output

```

Gumbo Software, Inc.
Report Manager Quick Start Example
4/01/11 17:34:52

Hello world!

AAAAAAAAAAAAAAAAAAAAAAAAAAAAAAAAAAAAAAAAAAAAAAAAAAAAAAAAAAAA
AAA  Report Manager - Gumbo Software Inc.  AAA
AAAAAAAAAAAAAAAAAAAAAAAAAAAAAAAAAAAAAAAAAAAAAAAAAAAAAAAAAAAA
                QPGMR
RRRR  M  M  PPPP  RRRR  TTTT  FFFF
R  R  MM MM  P  P  R  R  T  F
R  R  M M M  P  P  R  R  T  F
RRRR  M M M  PPPP  RRRR  T  FFFF
R  R  M  M  P  R  R  T  F
R  R  M  M  P  R  R  T  F
R  R  M  M  P  R  R  T  F
                DSP03
EEEE  X  X  AAA  M  M  PPPP  L  EEEEE
E  X  X  A  A  MM MM  P  P  L  E
E  X  X  A  A  M M M  P  P  L  E
EEEE  X  A  A  M M M  PPPP  L  EEEE
E  X  X  AAAAA  M  M  P  L  E
E  X  X  A  A  M  M  P  L  E
EEEE  X  X  A  A  M  M  P  LLLLL  EEEEE

AAAAAAAAAAAAAAAAAAAAAAAAAAAAAAAAAAAAAAAAAAAAAAAAAAAAAAAAAAAA
AAAAAAAAAAAA  Pages: 1 Copies: 1  AAAAAAAAAA
AAAAAAAAAAAAAAAAAAAAAAAAAAAAAAAAAAAAAAAAAAAAAAAAAAAAAAAAAAAA
  
```

Extract a report for the supplied sample program:

```
EXTRPT PGM(RMHHELLO) TOLIB(my_library)
```

Note: The net effect of this step is the same as creating a report using the CRTRPT command and specifying the name of the program that creates the spooled files:

```
CRTRPT RPT(my_library/RMHHELLO) SEL(RMHHELLO)
```

Note: You can determine the name of the program that created a spooled file by displaying the spooled file's attributes.

Again call the sample program to create a one page spooled file:

```
CALL PGM(RMHHELLO)
```

This time the report writer is able to identify the spooled file as report RMHELLO. It does this by match the "Program that opened file" from the spooled file's attributes to the report's selection criteria. The separator page is generated with the report name (RMHELLO) in place of the spooled file name (RMPRTF) and the subscription list (*NONE) in place of the user data (EXAMPLE) from the spooled file. The separator is followed by the **Hello world!** report similar to the following:

Figure: 2nd Separator Page And RMHELLO Output

```

Gumbo Software, Inc.
Report Manager Quick Start Example
4/01/11 17:41:56

Hello world!

BBBBBBBBBBBBBBBBBBBBBBBBBBBBBBBBBBBBBBBBBBBBBBBBBBBBBBBB
BBB Report Manager - Gumbo Software Inc. BBB
BBBBBBBBBBBBBBBBBBBBBBBBBBBBBBBBBBBBBBBBBBBBBBBBBBBBBBBB
          QFGMR
RRRR M M H H EEEEE L L OOO
R R MM MM H H E L L O O
R R M M M H H E L L O O
RRRR M M M HHHH EEEE L L O O
R R M M H H E L L O O
R R M M H H E L L O O
R R M M H H EEEEE LLLL LLLL OOO
          DSP03

Subscriber      Report      Delivery
Name            Copies      Group      Point
-----
*NONE           1      RPTMGR

BBBBBBBBBBBBBBBBBBBBBBBBBBBBBBBBBBBBBBBBBBBBBBBBBBBBBBBB
BBBBBBBBBBB Pages: 1 Copies: 1 BBBB
BBBBBBBBBBBBBBBBBBBBBBBBBBBBBBBBBBBBBBBBBBBBBBBBBBBBBBBB

```

Note: The separator bars are printed with B's in place of the A's used for the first separator page. Report writers use the next letter of the alphabet for each new separator to aide in locating all separators in a stack of printed output.

Add 2 subscriptions to the RMHELLO report, one for yourself and one for the system operator with the following commands:

```
ADDRPTSUB RPT(my_library/RMHHELLO)
ADDRPTSUB RPT(my_library/RMHHELLO) USER(QSYSOPR)
```

Note: You must have some authority other than ***EXCLUDE** to the QSYSOPR user profile in order to add a subscription on behalf of QSYSOPR. If you do not have authority, omit the second command.

Again call the sample program to create a one page spooled file:

```
CALL PGM(RMHHELLO)
```

This time the separator page lists the subscribers. The report writer prints 2 copies of the **Hello world!** report to satisfy the subscriptions:

Figure: 3rd Separator Page And 2 Copies Of RMHELLO Output

```

Gumbo Software, Inc.
Report Manager Quick Start Example
4/01/11 17:46:31

Hello world!

CCCCCCCCCCCCCCCCCCCCCCCCCCCCCCCCCCCCCCCCCCCCCCCCCCCCCCCCCCCC
CCC   Report Manager - Gumbo Software Inc.   CCC
CCCCCCCCCCCCCCCCCCCCCCCCCCCCCCCCCCCCCCCCCCCCCCCCCCCCCCCCCCCC
                QPGMR
RRRR  M  M  H  H  EEEEE  L    L    OOO
R  R  MM MM H  H  E      L    L    O  O
R  R  M M M H  H  E      L    L    O  O
RRRR  M M M HHHH  EEEE   L    L    O  O
R  R  M  M  H  H  E      L    L    O  O
R  R  M  M  H  H  E      L    L    O  O
R  R  M  M  H  H  EEEEE  LLLL  LLLL  OOO
                DSP03

Subscriber      Report      Delivery
Name            Copies      Group       Point
-----
QPGMR           1      RPTMGR
QSYSOPR        1      RPTMGR

CCCCCCCCCCCCCCCCCCCCCCCCCCCCCCCCCCCCCCCCCCCCCCCCCCCCCCCCCCCC
CCCCCCCCCCC   Pages: 1 Copies: 2   CCCCCCCCCC
CCCCCCCCCCCCCCCCCCCCCCCCCCCCCCCCCCCCCCCCCCCCCCCCCCCCCCCCCCCC

```

Add another subscription to the RMHELLO report for yourself. This one will call a program to notify you each time the report is processed:

```

ADDRPTSUB  RPT(my_library/RMHELLO)  SUBNBR(2)  OUTQ(*NONE)
           USRPRCPGM(RMCLNOTIFY)

```

Note: The source code for program RMCLNOTIFY is included as an example in the source file RMSOURCE.

Again call the sample program to create a one page spooled file:

```
CALL  PGM(RMHELLO)
```

This time the printed output remains as before but a message is sent to your message queue notifying you of the report. To display the message enter the following command:

```
DSPMSG
```

Figure: Notify Message For Report RMHELLO

```
Display Messages
System: GUMBO
Queue . . . . . : QPGMR      Program . . . . . : *DSEMSG
Library . . . . . : QUSRSYS   Library . . . . . :
Severity . . . . . : 00       Delivery . . . . . : *NOTIFY

Type reply (if required), press Enter.
From . . . . . : QPGMR      04/01/11 17:51:58
Subscription to report RMHELLO has been processed

F3=Exit      F11=Remove a message      F12=Cancel
F13=Remove all  F16=Remove all except unanswered  F24=More keys
```

End the example and the report writer by entering the following command:

```
ENDWTR WTR(my_device)
```

Display history for the example by entering the following command:

```
DSPRPTLOG
```

Work with the spooled files from the example by entering the following command:

```
WRKRPTSPLF SELECT(*ALL)
```

Chapter 4 Menu

What's In This Chapter

This chapter describes how to access the Report Manager menu, and reviews the functions that can be performed from the menu.

Accessing The Menu

The Report Manager commands and functions that you will use most often are collected on a menu named RPTADM. To access this menu use the Go To Menu (GO) command:

```
GO MENU (RPTMGR/RPTADM)
```

Library RPTMGR is added to the product portion of the current thread's library list while the menu is displayed.

Menu Options

```
RPTADM                      Report Manager Admin                      System:  RM1

Select one of the following:

    1. Online Manual

    2. Work with Reports                      WRKRPT
    3. Work with Report Writer                WRKRPTWTR
    4. Work with Report Output Queue          WRKRPTOUTQ
    5. Work with Report Spooled Files         WRKRPTSPLF
    6. Display Report Log                     DSPRPTLOG
    7. Display Mail Log                       DSPMAILLOG

Other Options
    10. Verify the product is installed correctly
    11. Change Banner Definition              CHGBNRDFN
    12. Dump Page Index Positions             DMPPIP
    13. Change Report Manager Authorization   CHGRMLAUT
                                                More...

Selection or command
===>

F3=Exit  F4=Prompt  F9=Retrieve  F12=Cancel
© Copyright Gumbo Software, Inc. 1992, 2011. All Rights Reserved.
```

The options on the Report Manager Admin (RPTADM) menu are the functions you will use most often. For a complete list of commands, see the Report Manager (RPTMGR) menu

The Report Manager Admin (RPTADM) menu options are summarized below:

Note: See the individual command descriptions for a complete explanation of each option.

Option 1. Online Manual

The online manual allows you to view the contents of the Report Manager Manual from a work station.

Option 2. Work with Reports

The Work with Reports (WRKRPT) command shows a list of reports from one or more libraries.

Option 3. Work with Report Writer

The Work with Report Writer (WRKRPTWTR) command gives the status of report writers. This can be the overall status of all report writers, or the detailed status of a specific report writer.

Option 4. Work with Report Output Queue

The Work with Report Output Queue (WRKRPTOUTQ) command shows the detailed status of a specific output queue. All spooled files on the output queue are displayed including those not yet processed by a report writer.

Option 5. Work with Report Spooled Files

The Work with Report Spooled Files (WRKRPTSPLF) command displays a list of selected spooled files that have been processed by a report writer. The display can be restricted by report, by output queue, by time period and by additional selection criteria.

Option 6. Display Report Log

The Display Report Log display shows entries from the report distribution log.

Option 7. Display Mail Log

The Display Mail Log (DSPMAILLOG) command shows the system mail log (IBM i journal QZMF). The mail log contains information about the processing of mail.

Option 10. Verify the product is installed correctly CHKPRDOPT

Installation verification checks to make sure that Report Manager has been correctly installed by running IBM i's Check Product Option (CHKPRDOPT) command.

Option 11. Change Banner Definition

The Change Banner Definition (CHGBNRDFN) command changes the size, appearance, arrangement and selection of elements specified in a banner definition for printing by the Report Manager supplied separator programs *BANNER and *PACKSLIP.

Option 12. Dump Page Index Positions

The Dump Page Index Positions (DMPPIP) command prints the line and position values, for data found in the spooled file, as calculated by the software. These are used to specify data selection criteria for the spooled file.

Option 13. Change Report Manager Authorization

The Change Report Manager Authorization (CHGRM1AUT) command changes the authorization code for Report Manager. The command is used to extend a demonstration period or to permanently authorize Report Manager for a system or a partition.

Option 14. All Report Manager command.

The Report Manager (RPTMGR) menu lists all Report Manager commands by category.

Option 15. Work with Example Program Source Code

The examples provided in source file RMSOURCE provide useful functions and demonstrate coding techniques used with Report Manager.

Option 16. Mail Verification And Set Up Menu

The Mail Verification And Set Up menu provides commands to help you set up mail on your system and verify that it is operating correctly.

Option 17. Display Page Data

The Display Page Data (DSPPAGDTA) command shows the contents of a spooled file's pages at specified locations. The contents can be shown, printed, or directed to database output file (OUTFILE).

Option 18. Check Report Manager Authorization

The Check Report Manager Authorization (CHKRM1AUT) command executes Report Manager's authorization verification function. This allows you to determine whether and how the product is authorized for use.

Chapter 5 Set Up

What's In This Chapter

This chapter provides information on setting up Report Manager. The chapter:

- Gives an overview of Report Manager set up.
- Describes how to obtain large separator pages on a printer.
- Describes how to choose a report library.
- Describes how to choose a report writer.
- Describes how to start report writers.
- Describes how report writers treat spooled files.
- Describes how to create reports.
- Describes how to verify that reports are correct.
- Describes how to set up an environment for report testing.
- Describes how to adjust a report's form type and copies.
- Describes how to add subscriptions.
- Describes how to add report filters.
- Describes how to archive spooled files.
- Describes how to set up form types.
- Includes a summary of recommendations.

The ideas presented may not be applicable to your situation or intended use.

Overview

Setting up Report Manager to manage your spooled files involves two parts, definition and operation.

Definition involves describing your spooled file distribution requirements to Report Manager. You do this by creating Report Manager reports and adding subscriptions and filters to them.

Operation involves instructing Report Manager to process the spooled files in output queues. You do this by starting a Report Manager "report writer" for each output queue that contains spooled files to process.

The following sections provide information on performing Report Manager set up.

Printing Separator Pages

If large separator pages are the only requirement for the printer, use the Start Report Writer (STRRPTWTR) command in place of the Start Printer Writer (STRPRTWTR) command. For example if the printer is usually started with the command:

```
STRPRTWTR  DEV (PRT01)
```

Substitute the command:

```
STRRPTWTR  DEV (PRT01)  RPTLIBL (*NONE)
```

See also the section on starting report writers later in this chapter.

The Change Banner Definition (CHGBNRDFN) command changes the size, appearance, arrangement and selection of elements specified in a banner definition for printing by the Report Manager supplied separator programs *BANNER and *PACKSLIP.

Choosing A Report Library

Reports may be created in any library. There are many possible approaches and strategies for organizing reports in libraries.

One approach is to create reports in the same library as the application programs that create the spooled output files. Accounting reports are created in the accounting program library, inventory reports are created in the inventory program library, etc. This method may simplify back up and recovery and reduces the need for additional libraries on the system.

Another approach is to create a library for reports for each group, functional area or department. A finance report library is created for the finance group; a marketing report library is created for the marketing group, etc. This method could simplify security procedures especially when recipients are maintaining their own subscriptions.

Another approach is to create a single library named REPORTS and place all reports in it. This method may simplify trouble-shooting of report selection criteria and administering report subscriptions. A single library named REPORTS is assumed for the rest of this chapter in order to simplify the discussion. To create a library named REPORTS, enter the following command:

```
CTRLIB LIB(REPORTS) TEXT('Report Manager report library')
```

Choosing Report Writers

Each report writer distributes spooled files as they arrive on an output queue. Report writers perform additional processing depending on the value specified for the printer device (DEV) parameter of the Start Report Writer (STRRPTWTR) command. The possible DEV() parameter values are:

- Printer Device** The report writer drives a printer in addition to distributing spooled files. Separator pages may be generated and the spooled files are printed in the order specified on the print options (PRTOPT) parameter of the report writer. Use a printer device when separator pages or better print ordering are the goal.
- *NONE** The report writer does not perform any additional processing and only performs distribution work. Use ***NONE** when distribution is the only function the report writer should perform.
- *NULL** The report writer acts as if it is driving a printer device but no paper is generated. Instead the spooled files are "printed" by placing them on the default destination output queue in the order in which they would have printed had a printer device been specified. Separator pages may be generated and the spooled files are printed in the order specified on the print options (PRTOPT) parameter of the report writer. Use ***NULL** for testing without wasting paper and tying up a printer.
- *RMT** The report writer treats the output queue as that of a remote printer device and performs processing as if a printer device had been specified. Use ***RMT** when the printer is a network device.

The following table summarizes the differences in report writers:

Figure: Report Writer Function Summary

Function	DEV() Parameter Value			
	printer	*RMT	*NONE	*NULL
Generate separators	*YES	*YES	*NO	*YES
Print options affect order	*YES	*YES	*NO	*YES
Print paper	*YES	*YES	*NO	*NO
Optimize affects order	*YES	*YES	*NO	*NO
DFOUTQ(*PRINT) allowed	*YES	*YES	*NO	*NO
Archives when requested	*YES	*YES	*YES	*YES

The rest of this chapter is directed at report writers that are driving a printer device however most of the information also applies to other report writers as well.

Starting Report Writers

A report writer is similar to and takes the place of a system supplied printer writer. If a printer writer is in control of a printer, a report writer can not be started using that printer. To start a report writer in place of a printer writer, use the Start Report Writer (STRRPTWTR) command in place of the Start Printer Writer (STRPRTWTR) command.

At many installations writers are automatically started by a system start up program. The name of the system start up program is contained in the system value QSTRUPPGM. To determine the name of the start up program enter the following command:

```
DSPSYSVAL  SYSVAL (QSTRUPGM)
```

IBM i is shipped with start up program QSYS/QSTRUP. In this program printer writers for all printers are started with the command:

```
STRPRTWTR  DEV (*ALL)
```

To modify this program to start a report writer in place of a printer writer for a particular printer, insert the report writer start above the general start of printer writers:

```
RPTMGR/STRPRTWTR  DEV (device-name)  RPTLIBL (REPORTS)  
STRPRTWTR  DEV (*ALL)
```

Note: Replace **REPORTS** with library name(s) appropriate to your library strategy.

Note: As delivered, IBM i runs the start up program under the QPGMR user profile which does not have the *SPLCTL special authority. Unless you grant *SPLCTL special authority to QPGMR or modify the start up job description, report writers started by the start up program may not be able to process spooled files completely.

The recommended approach is to postpone modifying start up procedures until implementation is nearly complete. This allows experimentation with various Start Report Writer (STRRPTWTR) command parameters to determine the best use, the correct report library list, banner printing requirements, etc. for each printer. To start a report writer after a printer writer has been started for a printer, first run an End Writer (ENDWTR) command before running the Start Report Writer (STRRPTWTR) command.

```
ENDWTR      WTR (device-name)  
STRRPTWTR  DEV (device-name)  RPTLIBL (REPORTS)
```

Note: Replace **REPORTS** with library name(s) appropriate to your library strategy.

Managed And Unmanaged Spooled Files

A report writer treats each spooled file as one of two types, either as a managed spooled file or as an unmanaged spooled file. Reports contain spooled file selection criteria that report writers match against the attributes of a spooled file. An unmanaged spooled file does not match the selection criteria of any report in a report writer's report library list. A managed spooled file is one that matches the selection criteria of at least one report in the report writer's report library list.

Note: A spooled file that is considered to be managed by one report writer could be considered unmanaged by another report writer when the report library lists are different. A report writer that specifies a report library list of ***NONE** considers all spooled files to be unmanaged.

Managed spooled files are distributed in accordance with the information contained in the report and its subscriptions. Unmanaged spooled files are moved to the output queue named by the default destination queue (DFTOUTQ) parameter on the Start Report Writer (STRRPTWTR) command. Unless otherwise specified, the default destination queue for report writer is ***PRINT**. A report writer default destination of ***PRINT** allows spooled files that are not currently managed by Report Manager to pass through the report writer and print as they did before Report Manager was installed.

During the later stages of implementation, when there should be no unmanaged spooled files appearing on the output queue, changing the default destination to a held output queue provides an easy method of identifying spooled files that are not being managed.

Creating Reports

Reports contain selection criteria that allow a report writer to identify spooled files. Reports must be created in order for report writers to perform distribution processing. It may be possible for Report Manager to perform this function automatically using the Extract Report (EXTRPT) command.

The Extract Report (EXTRPT) command extracts reports from existing applications. The command is intended to assist in the implementation of Report Manager. It takes advantage of the fact that the vast majority of reports can be identified by the name of the program that creates them or by the name of the program and the name of the spooled file.

The Extract Report (EXTRPT) command analyzes the references of the specified program(s) to identify programs that are printing reports. A Create Report (CRTRPT) command with approximations for parameter values is issued for each report found. The accuracy of the reports created will vary from application to application and depends in part on the software construction techniques in use. For the best results, insure that libraries containing the files referenced by the specified program(s) are in your library list. Review the reports created by this command, correcting parameters as required.

The recommended approach is to run the Extract Report (EXTRPT) command, placing the results in library REPORTS. Review the reports created using the Work with Reports (WRKRPT) command.

Example 1:

```
EXTRPT RPT(INVENTORY/*ALL) TOLIB(REPORTS)
```

This command analyzes all programs in library INVENTORY. For programs that create printed output, a report is created and placed in library REPORTS.

Example 2:

```
EXTRPT RPT(INV*) TOLIB(*PGMLIB)
```

This command analyzes all programs found in the thread's library list whose names begin with "INV". For programs that create printed output, a report is created and placed in the same library as the program.

Verifying Reports

Correctly specifying report selection criteria is one of the more error prone parts of implementing report distribution with Report Manager. This is because the selection criteria of reports are not entirely independent of each other, but depend in part on the order of processing by a report writer. If processed first, an incorrectly specified report can select spooled files that otherwise belong to a correctly specified report. This section describes methods for verifying report definitions with minimum risk of disrupting report distribution.

During initial implementation the recommended approach is to create all reports with both the FORMTYPE and COPIES parameters set to *SPLF, and to use a report writer with SEPPGM parameter set to *BANNER before any subscriptions are added.

Note: *SPLF is the default value for FORMTYPE and COPIES, and the value used by the Extract Report (EXTRPT) command. *BANNER is the default value for SEPPGM.

With this approach the report writer will not change any spooled files. It will perform selection processing to determine a report name which will print on the separator page. Verifying the report definitions is accomplished by monitoring the separator pages for accuracy. Even if the report writer selects the wrong report name, the usual number of copies will be printed on the usual form type.

After initial implementation, the recommended approach is to add an extra subscription to a new report. The extra subscription should specify an output queue that is not attached to a printer as its destination. This will serve as an insurance copy useful for recovery if the new report introduces distribution errors. The spooled files created must be deleted when no longer needed. The subscription can be added with an expiration date that allows enough time to verify that the new report is correct but eventually discontinues delivery. The subscription can be removed when no longer needed.

Alternately, specifying an archive library name on all new reports provides the same ability to recover. Report writers will create a spooled file archive for each spooled file processed for the report.

Creating A Test Environment

An alternate method for verifying that a new report is correct is to set up a test environment where the new report can be tested. To set up a test environment and test a new report:

- Create two test output queues one named TSTSRC, the other TSTTRG.

```
CRTOUTQ  OUTQ (TSTSRC)
CRTOUTQ  OUTQ (TSTTRG)
```

- Create a test version of each library in the report writer's report library list.

```
CRTLIB  LIB (REPORTSTST)  TEXT ('Report test versions')
```

- Create copies of the current reports in the test libraries.

```
CRTDUPOBJ  OBJ (*ALL)  FROMLIB (REPORTS)
           OBJTYPE (*USRIDX)  TOLIB (REPORTSTST)
```

- Create the new report to be tested in the test version of its intended library.

```
CRTRPT  RPT (REPORTSTST/new-report-name) ...
```

- Put the test version of the reports on hold.

```
HLD RPT  RPT (REPORTSTST/*ALL)
```

- Start a printerless report writer using the output queues and test libraries created in the steps above.

```
STRRPTWTR  DEV (*NULL)  OUTQ (TSTSRC)
           DFTOUTQ (TSTTRG)  RPTLIB (REPORTSTST)
```

- Duplicate spooled files to the test output queue TSTSRC and monitor the operations of the report writer to see if the spooled files are correctly identified. Holding the reports prevents the test spooled files from actually being delivered.

Note: Spooled files can be duplicated using the Duplicate Spooled File (DUPSPLF) command. Report writer operations can be monitored using the Work with Report Writer (WRKRPTWTR) command, and using the Display Report Log (DSPRPTLOG) command.

The above instructions may need modification to account for the specific situation at your installation.

Adjusting Form Type And Copies

Once reports have been set up and a report writer is processing the spooled files from an output queue, the form type and number of copies that print can be controlled without changing the application software that creates a report's spooled files. They can be controlled through the report, through subscriptions or through a combination of the two. This section describes how to adjust form type and copies through the report, and the considerations for doing so.

Determine the form type and number of copies of the report that should print. If the report has been in operation for a while with FORMTYPE(*SPLF) and COPIES(*SPLF), the report log will show the values currently generated by the application software. Use the Display Report Log (DSPRPTLOG) command to display recent activity for the report.

Use the Change Report (CHGRPT) command to update the FORMTYPE and COPIES parameters to the required values. If the requirements change, change the report to reflect them.

By default, subscriptions use the form type specified on the report. If there are subscriptions that use the default you must be careful when changing the form type of a report. Consider the following situation of a report with 1 subscription:

```
FORMTYPE ()  COPIES ()  total copies
-----  -----  -----
```

```
report          STD1PLY          6          6
subscription 1  *RPT             1          1
```

Now consider the results of changing the report to print 1 copy of 6 ply paper instead of 6 copies of 1 ply paper:

```
          FORMTYPE ()   COPIES ()   total copies
          -----   -----   -----
report          STD6PLY          1          6
subscription 1  *RPT             1          6
```

The recommended approach is to specify a form type that produces 1 physical copy on the report if distribution will be controlled through subscriptions, or to specify an explicit form type on subscriptions if a combination of reports and subscriptions is used.

Adding Subscriptions

Adding subscriptions is not required to control the number of copies of a report to print. However doing so documents the distribution of a report and allows you to use the full function of a report writer.

Determine the recipients of each report and add a subscription for each. When adding subscriptions, the recommended approach is to take the default values for destination output queue on the report (***WTR**) and subscriptions (***RPT**) for an initial period. With this approach the report's copies will all print at the printer specified on the report writer where the subscription information can be checked for accuracy. Once the subscriptions are accurate, the destination output queues can be assigned based on delivery convenience, etc. using the Change Report Subscription (CHGRPTSUB) command.

If all subscriptions can not be added at the same time, the report's COPIES parameter can be used to print additional copies for recipients not covered by subscriptions.

Adding Report Filters

A report filter specifies test criteria for a report that are used to reduce the number of pages delivered for a subscription. After a filter has been added to a report, it may be specified on one or more subscriptions. When a report writer processes the subscription, it tests each page of the spooled file against the filter criteria to determine if the page is selected for distribution. A page is selected when the data on the page meets the criteria specified.

All selected pages are placed in a new spooled file. If the user data (USRDTA) attribute of the original spooled file is blank, the new spooled file has the filter's name for user data.

The easiest way to accurately determine the line and position of the compare value in a spooled file is to display it using Display Spooled File (DSPSPLF) command. This is the same as option 5 of the Work with Output Queue (WRKOUTQ) command. With the spooled file displayed, type **+1** in the control field at the top of the panel. Press enter until the compare value is the first line on the panel. The line number at the top right of the panel now shows the correct line number. Use the ruler to determine the start position for the compare value.

This method works for most spooled files. For complex spooled files with field overlapping and/or font specifications the display results may differ from the results generated by Report Manager's print data stream parsers. A definitive value for locating data on page can be generated using the Dump Page Index Positions (DMPPIP) command. Dump the spooled file using the command and located positioning information for the data in the generated report.

You can test that filter selection criteria select the expected pages using the Archive Spooled File (ARCSPLF) and Retrieve Spooled File (RTVSPLF) commands. First locate the file name, job identification and spooled file number of a representative spooled file, and archive it to QTEMP:

```
ARCSPLF FILE(my_file) ARC(QTEMP/*GEN)
          JOB(999999/my_user/my_job) SPLNBR(999999)
```

Next retrieve the spooled file specifying the Page compare data (PAGCMPDTA) parameter you are testing:

```
RTVSPLF  ARC(QTEMP/*GEN) FILE(my_file)
          JOB(999999/my_user/my_job)
          SPLNBR(999999) PAGCMPDTA(1 1 'my_test_data')
```

Review the retrieved spooled file for accuracy.

Archiving Spooled Files

Choose a level of archiving based on the requirements for reproducing spooled files.

To archive every spooled file processed by a report writer, specify a name on the "Library to receive archive" (ARCLIB) parameter of the Start Report Writer (STRRPTWTR) command. This will insure that every spooled file can be reproduced using the Retrieve Spooled File (RTVSPLF) command.

Library QRPLOBJ is cleared at each IPL. You can maintain temporary archives for all spooled files processed by a report writer using the QRPLOBJ library:

```
STRRPTWTR  DEV(device-name)  ARCLIB(QRPLOBJ)  ...
```

To archive the spooled files of a specific report only, specify a name on the "Library to receive archive" (ARCLIB) parameter of the Create Report (CRTRPT) or Change Report (CHGRPT) commands. Any report writer that processes a spooled file for the report will create an archive.

Note: A "Library to receive archive" (ARCLIB) parameter is provided on both reports and report writers. When both are specified, the report takes precedence.

Individual spooled files may be archived using the Archive Spooled File (ARCSPLF) command. This can be done in addition to or instead of archiving performed by report writers. The Archive Spooled File (ARCSPLF) command can be entered on any command line or included in Control Language (CL) programs.

The following control language code fragment shows how to archive the spooled file my_file created by program my_program. The archive is placed into library my_library with a name of my_archive:

```
...
OVRPRTF  FILE(my_file) HOLD(*YES)
CALL     PGM(my_program)
ARCSPLF  FILE(my_file) ARC(my_library/my_archive)
RLSSPLF  FILE(my_file) SPLNBR(*LAST)
DLTOVR   FILE(my_file)
...
```

To create a new spooled file identical to the spooled file archived by this code fragment, enter the following command:

```
RTVSPLF  ARC(my_library/my_archive)
```

Creating Form Types

Most installations already have a form type naming convention in use. These names and the number of physical copies each produces may be identified to Report Manager for later use with reports and subscriptions. It may be possible for Report Manager to perform this function automatically using the Extract Form Type (EXTFRMTYP) command.

The Extract Form Type (EXTFRMTYP) command extracts form type names from existing printer files. For each form type found on the specified printer file(s), a Create Form Type (CRTFRMTYP) command is issued with the physical copies parameter set to 1. The usefulness of the information extracted will vary from system to system and depends in part on the software construction techniques in use.

Example 1:

```
EXTFRMTYP  PRTF(INVENTORY/*ALL)
```

This command extracts the names of form types used in all printer device files found in library INVENTORY.

Example 2:

```
EXTFRMTYP  PRTF (*ALLUSR/*ALL)
```

This command extracts the names of form types used in all printer device files found in all user libraries on the system.

Evaluate the results of the command using the Work with Form Types (WRKFRMTYP) command. Correct the physical copies parameter for each form type as required. Check the list of form types for completeness. Additional or new form types can be added using the Create Form Type (CRTFRMTYP) command directly.

Example 1:

```
CRTFRMTYP  FRMTYP(STD2)  PHYCOPIES(2)  TEXT('Two part *STD')
```

This command creates a form type named STD2 which produces 2 physical copies when printed. STD2's text describes it as the 2 ply equivalent of *STD.

Example 2:

```
CRTFRMTYP  FRMTYP(INVOICE)  TEXT('Duplicate Invoice')
```

This command creates a form type named INVOICE which produces 1 physical copy when printed. INVOICE's text describes it as a duplicate invoice.

Note: The form type name should follow IBM i rules for valid object names. The name cannot be *ALL, *FORMS, *RPT, *SAME, or *SPLF as these are reserved parameter special values. Otherwise any character string is accepted to insure compatibility with existing printer files and programs.

A form type identifies a particular kind of paper, preprinted form or other material that is used by a printer device. Typical examples of forms used in printing are:

- 14 7/8" x 11" 15 pound continuous green bar 1 part
- 9 1/2" x 11" continuous green bar 3 part carbonless
- 8 1/2" x 11" bond 20 pound cut sheet
- continuous preprinted checks
- 3 1/2" x 15/16" continuous 2 across pressure sensitive labels

The number of physical copies produced by a form type is the number of deliverable copies produced by one printing of the form. For example if the form has two plies, each of which is a complete copy after they are separated, the number of physical copies is 2. If the form has two plies but together they are one complete copy as in the case of a two part invoice then the number of physical copies is 1.

Summary Of Recommendations

The following is a summary of the recommendations found in this chapter.

- Use RPTLIBL(*NONE) if large separator pages are the only requirement for a printer.
- Postpone modifying start up procedures, manually start report writers.
- Select a library strategy and create libraries as required.
- Use Extract Report (EXTRPT) command to create reports.
- Start with FORMTYPE(*SPLF) COPIES(*SPLF) for reports and verify using a report writer with SEPPGM(*BANNER).
- Add an insurance subscription with expiration date to new reports, or specify an archive library name.
- Create an environment for report testing.
- Control form type and copies using Report Manager.
- Add subscriptions taking the defaults for destination output queue.
- Change subscriptions to most advantageous destinations.
- Test report filters before using them.
- Archive spooled files that may need to be reproduced.

- Use the Extract Form Type (EXTFRMTYP) command to create form types.

Chapter 6 Scenarios

What's In This Chapter

This chapter provides several problem scenarios and their solutions using Report Manager. The scenarios include:

- Setting Up A Simple System.
- Shielding Small Printers From Large Spooled Files.
- Delegating Distribution Maintenance.
- Insuring A Single Form Type For A Printer.
- Defining A Multi-Company Report.
- Splitting RJE Output Streams.

Setting Up A Simple System

The problem situation is as follows:

- A small system having three printers. The device names are:
 - PRT01 system printer in the computer room
 - ACCGT02 in the accounting department
 - PURCH03 in the purchasing department
- A company with four users. The user profile names are:
 - JOE an accountant
 - ANN a purchasing agent
 - TIM an inventory clerk
 - SUE a receiving clerk
- An application with two batch programs that create spooled output:
 - Program INV320 which prints inventory on hand
 - Program OPO117 which prints open purchase orders with a summary page. The summary page contains the text "Final Total" starting in position 53 of the last line. The last line can be any line on the page:

The programs are run at night and place their spooled files on output queue PRT01. The spooled files specify forms type *STD.

- Printer assignments:
 - JOE sits near printer ACCGT02 and is the sole user
 - ANN sits near printer PURCH03 but shares it with others
 - TIM receives output from the system printer PRT01
 - SUE receives output from the system printer PRT01
- Report distribution requirements:
 - Program INV320 inventory on hand
 - JOE receives 2 copies
 - TIM receives 1 copy
 - Program OPO117 open purchase orders
 - JOE receives 1 copy but only needs the summary page
 - ANN receives 1 copy but prefers form type *8X11
 - TIM receives 1 copy
 - SUE receives 1 copy
- Report archive requirements:
 - Reprints must be available for program INV320
 - Reprints are not required for program OPO117

Report Manager can be used to automatically process and distribute the reports by following these steps:

1. Create a library to hold the Report Manager reports:

```
CRTLIB LIB(REPORTS) TEXT('Sample system')
```

2. Create a report for each program. The reports will be distributed entirely from subscriptions, INV320 is archived to library QGPL to provide for reprint requests:

```
CRTRPT RPT(REPORTS/INV320) TEXT('Inventory on hand')
        ARCLIB(QGPL)
CRTRPT RPT(REPORTS/OPO117) TEXT('Open purchase orders')
```

3. Add a filter to report OPO117 that selects the summary page:

```
ADDRPTFTR RPT(REPORTS/OPO117) RPTFTR(SUMMARY)
           PAGCMPDTA(*ALL 53 'Final Total')
```

4. Add subscriptions to match the distribution requirements. Deliver reports according to the printer assignments:

```
ADDRPTSUB RPT(REPORTS/INV320) USER(JOE) OUTQ(ACCGT02)
           COPIES(2)
ADDRPTSUB RPT(REPORTS/INV320) USER(TIM)
ADDRPTSUB RPT(REPORTS/OPO117) USER(JOE) OUTQ(ACCGT02)
           RPTFTR(SUMMARY)
ADDRPTSUB RPT(REPORTS/OPO117) USER(ANN) OUTQ(PURCH03)
           FRMTYP(*8X11)
ADDRPTSUB RPT(REPORTS/OPO117) USER(TIM)
ADDRPTSUB RPT(REPORTS/OPO117) USER(SUE)
```

5. Modify the system start up program to start the writers:

```
STRRPTWTR DEV(PRT01) RPTLIBL(REPORTS)
STRPRTWTR DEV(ACCGT02)
STRRPTWTR DEV(PURCH03) RPTLIBL(*NONE)
```

JOE, the sole user of printer ACCGT02, does not want separator pages. Since reports are not distributed from the output queue a report writer is not required and an IBM i printer writer is started.

Reports are not distributed from the output queue for printer PURCH03 but separator pages are required. Therefore a report writer with a report library list of *NONE is used.

After the changes have been completed the nightly batch run produces the following results:

Figure: Sample Results (* = summary page only)

Report	Printer	Copies	Form type	Separator
INV320	PRT01	1	*STD	*YES
	ACCGT02	2	*STD	*NO
	PURCH03	0	—	—
OPO117	PRT01	2	*STD	*YES
	ACCGT02	1*	*STD	*NO
	PURCH03	1	*8X11	*YES

Shielding Small Printers From Large Spooled Files

The problem situation is as follows:

- A large capacity high speed printer with device name PRT01 is located in the computer room.
- Small capacity low speed printers are located in each department. The device names are:
 - SALES02 in the marketing department
 - PURCH03 in the purchasing department
 - ACCGT04 in the accounting department
- Users generate many of their own reports as needed and these are currently printed on the low speed printer nearest the user. Some of the reports can become quite large depending on the selection criteria entered. When this happens a departmental printer is tied up for a long period of time and a system operator must manually intervene to reroute reports around the busy printer.

Report Manager can be used to automatically reroute large reports to the high speed printer with the following steps:

1. Create a library to hold a Report Manager report:

```
CRTLIB LIB (PRTRROUTE) TEXT ('Print Routing')
```

2. Create a report that selects any spooled file that contains 20 pages or more and directs them to the system printer:

```
CRTRPT RPT (PRTRROUTE/SYSPRINT)
      COPIES (*SPLF) OUTQ (QUSRSYS/PRT01)
      SELECT (*ALL *ALL *ALL *ALL *ALL *ALL *ALL
            *ALL *ALL *ALL *ALL *ALL *ALL *ALL *ALL 20)
```

3. Add a subscription to the report on behalf of the user creating the large spooled file. The subscription calls the Report Manager supplied sample program which sends a message when the report is processed. In this way the creator of the spooled file will have an indication that the spooled file has been rerouted to the large printer.

```
ADDRPTSUB RPT (PRTRROUTE/SYSPRINT) USER (*CREATOR)
          OUTQ (*NONE) USRPRCPGM (RMCLNOTIFY)
```

4. Modify the system start up program to replace the Start Printer Writer (STRPRTWTR) commands for the low speed printers with Start Report Writer (STRRPTWTR) commands. The library containing the report created above is placed in the report library list of the report writers. Separator printing is turned off for the accounting department printer as the separators are not needed there.

```
STRRPTWTR DEV (SALES02) RPTLIBL (PRTRROUTE)
STRRPTWTR DEV (PURCH03) RPTLIBL (PRTRROUTE)
STRRPTWTR DEV (ACCGT04) RPTLIBL (PRTRROUTE) SEPPGM (*NONE)
```

When the changes have been completed, the printing of spooled files containing fewer than 20 pages will occur as before except that the marketing and purchasing printers now produce large print separators. The report writers will identify spooled files of 20 or more pages as report SYSPRINT and move them to the output queue of the high speed printer QUSRSYS/PRT01. In addition, a message is sent to the user who created the spooled file indicating that the spooled file has been rerouted and will not print on the local printer.

Defining A Multi-Company Report

The problem situation is as follows:

- Processing for 3 companies is performed on a single system.
- A single program named INVSTS is used to generate a report whose distribution depends on which company's libraries were used as input to the program.
- The jobs that create the INVSTS output for the companies are submitted using different job descriptions in order to place the correct libraries in front of program INVSTS by company. The job descriptions are:
 - COMPANY1 for the first company.
 - COMPANY2 for the second company.
 - COMPANY3 for the third company.
- Report Manager's Extract Report (EXTRPT) command creates a report based on selecting spooled files created by program INVSTS. This is inadequate for the required multi-company distribution.

Additional criteria of the Create Report (CRTRPT) command can be used to distinguish each company's report. In this case the job descriptions impart different job names to the spooled files created by program INVSTS. This distinction is used to achieve the desired results:

1. Delete the single report created by Report Manager's Extract Report (EXTRPT) command:

```
DLTRPT  RPT (INVSTS)
```

2. Create three reports for program INVSTS differentiated by job name:

```
CRTRPT  RPT (INVSTS1)  SELECT (INVSTS *ALL *ALL COMPANY1)
CRTRPT  RPT (INVSTS2)  SELECT (INVSTS *ALL *ALL COMPANY2)
CRTRPT  RPT (INVSTS3)  SELECT (INVSTS *ALL *ALL COMPANY3)
```

3. Add subscriptions to the reports to reflect the distributions required for each company:

```
ADDRPTSUB  RPT (INVSTS1)  USER (CO1MANAGER)
ADDRPTSUB  RPT (INVSTS2)  USER (CO2MANAGER)
ADDRPTSUB  RPT (INVSTS3)  USER (CO3MANAGER)
```

When the changes have been completed, report writers will distribute the output of program INVSTS differently depending on which company's data was processed.

Insuring A Single Form Type For A Printer

The problem situation is as follows:

- A small printer with device name RECEPTION is located in the reception area.
- A preprinted registration card form type named REGCARD is mounted on the printer.
- Clients are registered and their registration cards handed to them as they enter the building.
- On occasion, the registration process is disrupted when a spooled file specifying a form type other than REGCARD is placed on the RECEPTION output queue in error.

Report Manager can be used to automatically hold spooled files that do not specify the REGCARD form type.

1. Create a library to hold a Report Manager report:

```
CRTLIB  LIB (RECEPTION)
```

2. Create a report that selects any spooled file that specifies form type REGCARD specifying a selection sequence of 100:

```
CRTRPT RPT (RECEPTION/REGCARD) COPIES (*SPLF)
      SELECT (*ALL *ALL *ALL *ALL REGCARD) SELECTSEQ (100)
```

3. Create a report that selects any and all spooled files, specifies a selection sequence of 200, and is held:

```
CRTRPT RPT (RECEPTION/OTHER) HOLD (*YES) SELECT (*ALL)
      SELECTSEQ (200)
```

Using a sequence number larger than that of the REGCARD report insures that spooled files specifying form type REGCARD are selected by the REGCARD report.

4. Modify the system start up program to replace the Start Printer Writer (STRPRTWTR) command for the reception area printer with a Start Report Writer (STRRPTWTR) command. The library containing the reports created above is placed in the report library list of the report writer. Separator printing is turned off to prevent wasted stock.

```
STRRPTWTR DEV (RECEPTION) RPTLIBL (RECEPTION) SEPPGM (*NONE)
```

When the changes have been completed, the printing of spooled files with form type REGCARD will occur as before. All other spooled files are held by the report writer.

Delegating Distribution Maintenance

The problem situation is as follows:

- A large capacity high speed printer with device name PRT01 is located in the computer room. The printer is used to print the output from three applications running on the system. The three applications are:
 - Sales Analysis for the marketing department
 - Purchase Order Processing for the purchasing department
 - General Accounting for the accounting department
- Report Manager has been installed and reports created for each application. The reports are contained in a library named REPORTS.
- The company is expanding rapidly. The expansion generates a steady stream of requests from the three department heads for changes in the distribution of reports for their areas.
- The volume of changes is hard to keep up with, a written change request is seldom used and verbal instructions are sometimes misunderstood.

Report Manager can be used to allow the department heads to maintain the distribution of reports for their areas directly.

1. Create a library to hold the reports for each application, excluding users who are not specifically authorized:

```
CRTLIB LIB (SALESRPT) TEXT ('Reports') AUT (*EXCLUDE)
CRTLIB LIB (PURCHRPT) TEXT ('Reports') AUT (*EXCLUDE)
CRTLIB LIB (ACCGTRPT) TEXT ('Reports') AUT (*EXCLUDE)
```

2. Authorize the department managers to their respective report libraries. Additionally authorize the system operator:

```
GRTOBJAUT OBJ (QSYS/SALESRPT) OBJTYPE (*LIB) AUT (*USE)
          USER (SALESRPT QSYSOPR)
GRTOBJAUT OBJ (QSYS/PURCHRPT) OBJTYPE (*LIB) AUT (*USE)
```

```

                USER (PURCHMGR QSYSOPR)
GRTOBJAUT  OBJ (QSYS/ACCGTRPT)  OBJTYPE (*LIB)  AUT (*USE)
                USER (ACCGTMGR QSYSOPR)

```

3. Move reports to the appropriate library:

```

MOV OBJ (REPORTS/SALES*)  OBJTYPE (*USRIDX)
    TOLIB (SALESRPT)
MOV OBJ (REPORTS/PURCH*)  OBJTYPE (*USRIDX)
    TOLIB (PURCHRPT)
MOV OBJ (REPORTS/ACCGT*)  OBJTYPE (*USRIDX)
    TOLIB (ACCGTRPT)

```

4. Add access to the Work With Reports (WRKRPT) and Work With Report Subscriptions (WRKRPTSUB) commands to the managers' menus. Give the managers instructions on maintaining the report distributions for their areas.
5. Change the command that starts the computer room printer to reflect the new location of the reports:

```

STRRPTWTR  DEV (PRT01)
            RPTLIBL (SALESRPT PURCHRPT ACCGTRPT)

```

When the changes have been completed, the printing of spooled files will work as before and the department managers are able to maintain the subscriptions for their respective areas.

Splitting RJE Output Streams

The problem situation is as follows:

- Report Manager has been installed and is managing spooled file distribution and printing. Reports used to control distribution are in library REPORTS.
- An output stream containing two distinct reports is received daily from a host using RJE. RJE places the output stream in a single spooled file with form type PR04 taken from the host JCL //SYSUT2 DD SYSOUT=(A,,PR04).
- The heading on each page contains the report's name at line 2 position 3. These are:
 - INV321 - Inventory Transaction Listing
 - INV322 - Inventory Shortage Listing
- The two reports have different distributions requirements. These are:
 - INV321 - 3 copies for JOE.
 - INV322 - 1 copy for ANN.

Report Manager filters can be used to split the output stream contained in the spooled file into its constituent reports for distribution.

1. Create a report that selects the spooled file created by RJE based on the form type PR04:

```

CRTRPT  RPT (REPORTS/RJEPR04)
        SELECT (*ALL *ALL *ALL *ALL PR04)
        TEXT ('RJE Inventory Output Stream')

```

2. Add filters to select pages for the two reports:

```

ADDRPTFTR  RPT (REPORTS/RJEPR04)  RPTFTR (INV321)
            PAGCMPDTA (2 3 INV321)

```

```
ADDRPTFTR RPT (REPORTS/RJEPR04) RPTFTR (INV322)
          PAGCMPDTA (2 3 INV322)
```

3. Add subscriptions to match the distribution requirements.

```
ADDRPTSUB RPT (REPORTS/RJEPR04) USER (JOE) COPIES (3)
          RPTFTR (INV321)
ADDRPTSUB RPT (REPORTS/RJEPR04) USER (ANN) COPIES (1)
          RPTFTR (INV322)
```

When the changes have been completed, report writers that process the spooled file containing the RJE output stream will split it into the constituent reports and deliver the number of copies required.

Chapter 7 Commands

What's In This Chapter

This chapter describes the control language (CL) commands supplied by Report Manager. The commands are arranged in alphabetic order by command name (mnemonic). Each description includes environment and threadsafe classification, a brief general description, detailed parameter explanations, examples and message information. Additional explanatory material can be found in the *Programming > Control Language > CL Concepts > CL Commands > CL command information and documentation* topic in the IBM i Information Center at <http://publib.boulder.ibm.com/series/>.

Add Report Filter (ADDRPTFTR)

Where allowed to run: All environments (*ALL)

Threadsafe: No

The Add Report Filter (ADDRPTFTR) command adds a report filter to a report.

A report filter specifies test criteria for a report that are used to reduce the number of pages delivered for a subscription. After a filter has been added to a report, it may be specified on one or more subscriptions. When a report writer processes the subscription, it tests each page of the spooled file against the filter criteria to determine if the page is selected for distribution. A page is selected when the data on the page meets the criteria specified.

All selected pages are placed in a new spooled file. If the user data (USRDTA) attribute of the original spooled file is blank, the new spooled file has the filter's name for user data.

Parameters

Keyword	Description	Choices	Notes
RPT	Report	<i>Qualified object name</i>	Required, Positional 1
	Qualifier 1: Report	<i>Generic name, name, *ALL</i>	
	Qualifier 2: Library	<i>Name, *LIBL, *CURLIB, *USRLIBL, *ALLUSR, *ALL</i>	
RPTFTR	Report filter	<i>Name</i>	Required, Positional 2
PAGCMPDTA	Page compare data	<i>Element list</i>	Required, Positional 3
	Element 1: Line	1-255, *ALL	
	Element 2: Position	1-378, *ALL	
	Element 3: Compare value	<i>Character value</i>	
PAGCMPDTAA	Element 4: Compare test	<i>*EQ, *NE</i>	Optional
	Page compare data, more	Single values: <i>*NONE</i> Other values (up to 15 repetitions): <i>Element list</i>	
	Element 1: Conjunction	<i>*AND, *OR</i>	
	Element 2: Line	1-255, *ALL	
	Element 3: Position	1-378, *ALL	
	Element 4: Compare value	<i>Character value</i>	
Element 5: Compare test	<i>*EQ, *NE</i>		

Report (RPT)

Specifies the name of the report and the library where it resides.

This is a required parameter.

Qualifier 1: Report

- name*** Specify the name of the report.
- generic-name*** Specify a generic name. Reports whose names begin with the specified characters are selected.
- *ALL** All reports in the library or libraries are selected.

Qualifier 2: Library

- *LIBL** All libraries in the thread's library list are searched.
- *CURLIB** Use the current library for the job. If no library is specified as the current library for the job, QGPL is used.
- *USRLIBL** Only the libraries in the user portion of the thread's library list are searched.
- *ALL** All libraries in the system including QSYS are searched.
- *ALLUSR** All non-system libraries on the machine are searched.
- name*** Specify the name of the library.

Report filter (RPTFTR)

Specifies the name of the report filter. Filter names are unique within a report.

This is a required parameter.

name Specify the name of the filter.

Page compare data (PAGCMPDTA)

Specifies the comparison that determines which pages of a spooled file are selected for output. The comparison consists of a character string value and the line and position at which it is located.

This is a required parameter.

Element 1: Line

1-255 Specify the line number where the comparison starts on the page.
***ALL** All lines on the page are compared. If the compare value is found on at least one line, the page is selected.

Element 2: Position

1-378 Specify the position where the comparison starts in the line. Valid values range from 1 through 378. The value specified plus the length of the compare value should be less than the number of print positions in the spooled file.
***ALL** All positions in the line are compared. If the compare value is found in at least one position, the page is selected.

Element 3: Compare value

character-value Specify the value (up to 16 characters long) to be compared with the specified line/position on the page. Only the number of characters entered are compared to the page. The value must be specified in apostrophes if it contains leading or trailing blanks. The comparison is case sensitive.

Note: Leading and trailing blanks are not allowed when *ALL is specified for character position.

Element 4: Compare test

***EQ** If the compare data is located on the page, the page is selected.
***NE** If the compare data is not located on the page, the page is selected.

Page compare data, more (PAGCMPDTAA)

Specifies additional comparisons the page must meet to be selected for output, and the relationship between the comparisons. Up to 15 additional comparisons can be specified.

Use the *AND and *OR conjunctions, as needed, between pairs of comparisons to indicate how the comparisons are to be related and grouped. An *AND indicates that the pair must both be true before the results of the *AND can be true. An *OR value indicates that only one of the comparisons need to be true for the *OR to be true.

If all *ANDs are specified, only pages that meet all of the comparisons are selected. If you want to select all pages that meet at least one of the tests, specify *ORs to connect each one of the comparisons.

When you use both *ANDs and *ORs, each *OR separates groups of comparisons connected by *ANDs. Starting from the first comparison, if the results of all the *ANDs in a group are all true, the page is selected. If the comparisons are not all true, the next group of *ANDs are considered.

Single values

***NONE** There are no additional comparisons.

Element 1: Conjunction

***AND** An additional *AND comparison is performed.
***OR** An additional *OR comparison is performed.

Element 2: Line

1-255 Specify the line number where the comparison starts on the page.
***ALL** All lines on the page are compared. If the compare value is found on at least one line, the page is selected.

Element 3: Position

- 1-378** Specify the position where the comparison starts in the line. Valid values range from 1 through 378. The value specified plus the length of the compare value should be less than the number of print positions in the spooled file.
- *ALL** All positions in the line are compared. If the compare value is found in at least one position, the page is selected.

Element 4: Compare value

- character-value** Specify the value (up to 16 characters long) to be compared with the specified line/position on the page. Only the number of characters entered are compared to the page. The value must be specified in apostrophes if it contains leading or trailing blanks. The comparison is case sensitive.

Note: Leading and trailing blanks are not allowed when *ALL is specified for character position.

Element 5: Compare test

- *EQ** If the compare data is located on the page, the page is selected.
- *NE** If the compare data is not located on the page, the page is selected.

Examples

Example 1:

```
ADDRPTFTR RPTFTR(WESTERNREG) RPT(SOE112)
          PAGCMPDTA(3 12 'Region: Western')
```

This command adds a filter to report SOE112 which is located using the thread's library list. The filter, named WESTERNREG, selects all spooled file pages that contain the character string 'Region: Western' on line 3 in positions 12 through 26.

Example 2:

```
ADDRPTFTR RPTFTR(TOTALSONLY) RPT(INV310)
          PAGCMPDTA(*ALL 23 TOTALS)
```

This command adds a filter named TOTALSONLY to report INV310. The filter selects each page in a spooled file that contains the character string 'TOTALS'. All lines on the page are compared for a match. The comparison starts at position 23.

Add Report Subscription (ADDRPTSUB)

Where allowed to run: All environments (*ALL)

Threadsafe: No

The Add Report Subscription (ADDRPTSUB) command adds a subscription to a report on behalf of a subscriber.

Parameters

Keyword	Description	Choices	Notes
RPT	Report	<i>Qualified object name</i>	Required,
	Qualifier 1: Report	<i>Generic name, name, *ALL</i>	Positional 1
	Qualifier 2: Library	<i>Name, *LIBL, *CURLIB, *USRLIBL, *ALLUSR, *ALL</i>	
USER	User	<i>Name, *CURRENT, *CREATOR, *USRID, *CREATOR2</i>	Optional, Positional 2
USRID	Network user	Single values: <i>*NONE, *SPLFCRT, *SPLFOWN</i> Other values: <i>Element list</i>	Optional, Positional 3
	Element 1: User ID	<i>Character value</i>	
	Element 2: Address	<i>Character value</i>	
SUBNBR	Subscription number	1-255, <u>1</u>	Optional, Positional 4
OUTQ	Destination output queue	Single values: <i>*RPT, *WTR, *DEV, *USRPRF, *JOB, *NONE</i> Other values: <i>Qualified object name</i>	Optional, Positional 5
	Qualifier 1: Destination output queue	<i>Name</i>	
	Qualifier 2: Library	<i>Name, *LIBL, *CURLIB</i>	
PRTDEV	Printer device	<i>Name, *SYSVAL, *USRPRF, *NONE</i>	Optional, Positional 6
USRPRCPGM	User process program	Single values: <i>*NONE</i> Other values: <i>Qualified object name</i>	Optional, Positional 7
	Qualifier 1: User process program	<i>Name</i>	
	Qualifier 2: Library	<i>Name, *LIBL, *CURLIB</i>	
DELIVERY	Delivery point	<i>Character value, *RPT, *NONE</i>	Optional, Positional 8
FRMTYP	Form type	<i>Character value, *RPT, *SPLF</i>	Optional, Positional 9
COPIES	Copies	1-255, <u>1</u> , *SPLF	Optional, Positional 10
STRDATE	Start date	<i>Date, *IMMED</i>	Optional, Positional 11
ENDDATE	End date	<i>Date, *PERM</i>	Optional, Positional 12
HOLD	Hold	<i>*NO, *YES</i>	Optional, Positional 13
RPTFTR	Report filter	<i>Name, *NONE, *UNSELECT</i>	Optional, Positional 14
OMITZERO	Omit zero page delivery	<i>*RPT, *YES, *NO</i>	Optional, Positional 15
DLVSTS	Deliver status	<i>*RPT, *READY, *HELD</i>	Optional, Positional 16
SNDFMT	Send format	<i>*RPT, *ALLDATA, *RCDDATA, *EMAIL</i>	Optional, Positional 17
TRANSFORM	Transform to perform	<i>Character value, *RPT, *TXT, *PDFLETTER, *PDFLEGAL, *PDFA4, *RTFLETTER, *RTFLEGAL, *RTFA4</i>	Optional, Positional 18
TOOBJ	Object (PC file)	<i>Character value, *NONE, *ACGCDE, *BIN, *BIN8, *CRTSYS, *CRTUSR, *FILE, *FILE8, *FTR, *FTR8, *GRP, *GRP8, *JOBNAM, *JOBNAM8, *JOBNBR, *JOBUSR, *JOBUSR8, *OUTQ, *PAGECOUNT, *PAGECNTZ, *PGM, *PGM8, *PRTTXT, *RPT, *RPT8, *SPLCDAT, *SPLCTIM, *SPLCCYY, *SPLCYY, *SPLCMM, *SPLCDD, *SPLNBR, *SPLNBRZ, *SUB, *SUB8, *SUBNBR, *USRDTA, *USRDFNDA</i>	Optional, Positional 19

Report (RPT)

Specifies the name of the report and the library where it resides.

This is a required parameter.

Qualifier 1: Report

<i>name</i>	Specify the name of the report.
<i>generic-name</i>	Specify a generic name. Reports whose names begin with the specified characters are selected.
*ALL	All reports in the library or libraries are selected.

Qualifier 2: Library

*LIBL	All libraries in the thread's library list are searched.
*CURLIB	Use the current library for the job. If no library is specified as the current library for the job, QGPL is used.
*USRLIBL	Only the libraries in the user portion of the thread's library list are searched.
*ALL	All libraries in the system including QSYS are searched.
*ALLUSR	All non-system libraries on the machine are searched.
<i>name</i>	Specify the name of the library.

User (USER)

Specifies the user who is subscribed to the report.

*CURRENT	The subscription is for the user of the current job.
*CREATOR	The subscription is for the user creating the spooled file. Report writers resolve this value using the user portion of the qualified job name that contains the spooled file.
*CREATOR2	The subscription is for the user creating the spooled file. Report writers resolve this value using information in the spooled file's attributes. Use this value if the spooled file was originally created on another system.
*USRID	The subscription is for the network user identified by the USRID parameter.
<i>name</i>	Specify the name of the user profile.

Network user (USRID)

Specifies the network user who is subscribed to the report. A network user receives subscriptions on the local system or on a remote system as email or through the SNADS network. For email, subscriptions are delivered as a message with the spooled file placed in an attached file. For SNADS networks, subscriptions are placed on the output queue specified in the user profile of the network user. Network users are identified by a two part user ID or by a two part distribution list ID.

A network user receives subscriptions on the local system or on a remote system as email or through the SNADS network. For email, subscriptions are delivered as a message with the spooled file placed in an attached file. For SNADS networks, subscriptions are placed on the output queue specified in the user profile of the network user. Network users are identified by a two part user ID or by a two part distribution list ID.

Single values

*NONE	The subscription is not for a network user.
*SPLFCRT	The subscription is for the user creating the spooled file. Report writers resolve this value using information in the spooled file's attributes. Use this value if the spooled file was originally created on another system. The directory entry for the user profile is retrieved to determine the target User ID and Address.
*SPLFOWN	The subscription is for the user owning the spooled file. Report writers resolve this value using the user portion of the qualified job name that contains the spooled file. The directory entry for the user profile is retrieved to determine the target User ID and Address.

Element 1: User ID

character-value Specify the user ID (DEN) of the network user. CHAR(8)

Element 2: Address

character-value Specify the address (DGN) of the network user. CHAR(8)

Subscription number (SUBNBR)

Specifies the subscription number. Subscription numbers uniquely identify the subscriptions of an individual subscriber to a report. This allows a user or network user to subscribe to a report more than once.

Subscription numbers uniquely identify the subscriptions of an individual subscriber to a report. Subscription numbers allow a subscriber to subscribe to a report more than once.

<u>1</u>	Specifies subscription 1 for the subscriber.
1-255	Specify a subscription number.

Destination output queue (OUTQ)

Specifies the name of an output queue to which spooled files are delivered by a report writer. This parameter follows the rules of the OUTQ parameter of printer device files, job descriptions, user profiles and display devices outlined in *iSeries Printer Device Programming SC41-5713*.

Single values

*RPT	The output queue specified by the report is used.
*WTR	The destination is determined at the time a report writer is delivering spooled files. If the report writer is started with a printer device specified on the DEV parameter then the spooled file is printed. If DEV(*NONE) is specified when the report writer is started then the default destination queue (DFTOUTQ) parameter is used as the destination.
*DEV	The output queue associated with the printer device is used.
*USRPRF	The output queue specified in the user profile of the report subscriber is used.
*JOB	The output queue of the job that created the spooled file is used.
*NONE	Spooled files are not delivered to an output queue.

Qualifier 1: Output queue

<i>name</i>	Specify the name of the output queue.
-------------	---------------------------------------

Qualifier 2: Library

*LIBL	All libraries in the thread's library list are searched.
*CURLIB	Use the current library for the job. If no library is specified as the current library for the job, QGPL is used.
<i>name</i>	Specify the name of the library.

Printer device (PRTDEV)

Specifies the name of a printer device description to which spooled files are delivered by a report writer. This parameter follows the rules of the DEV parameter of printer device files, job descriptions, user profiles and display devices outlined in *iSeries Printer Device Programming SC41-5713*.

*NONE	Spooled files are not delivered to a printer device.
*SYSVAL	The printer device named in the QPRTDEV system value is used.
*USRPRF	The printer device specified in the user profile of the report subscriber is used.
<i>name</i>	Specify the name of the printer device to use.

User process program (USRPRCPGM)

Specifies the name of the user process program.

A user process program is a user written program that is given control by a report writer to perform functions not supplied by Report Manager. User process programs can be specified for a report and as the destination of subscriptions. A user process program specified for a report is given control after the report has been identified, and before any subscription staging has been performed. User process programs specified on subscriptions are given control after all subscriptions have been staged and before other subscriptions are delivered.

Report writers pass 2 parameters to user process programs, a spooled file attribute record and a log entry buffer.

spooled-file-attribute-record The attribute record contains specific information about the spooled file to process. The format of the record is identical to format SPLA0200 returned by system interface program QUSRSPLA. For the layout of this record and a complete discussion of its content see the *Programming > Application programming interfaces > QUSRSPLA - Retrieve Spooled File Attributes* topic in the IBM i Information Center at <http://publib.boulder.ibm.com/series/>.

log-entry-buffer The log entry buffer contains data from the report distribution log. The data has one of two formats depending on whether a report or a subscription is being processed:

- When the user process program is called because it was named on **USRPRCPGM** parameter of a report it is passed a report log entry.
 - A report log entry is identified by a record ID of "**E**" in the first position of the log buffer.
 - The format of the entry is identical to that of record RMEVTR in file RMEVT. For the layout of this record use the Display File Field Description (DSPFFD) command.
- When the user process program is called because it was named in the **USRPRCPGM** parameter as a subscription's destination, it is passed a subscription log entry.
 - A subscription log entry is identified by a record ID of "**D**" in the first position of the log buffer.
 - The format of the entry is identical to that of record RMDSTR in file RMDST. For the layout of this record use the Display File Field Description (DSPFFD) command.

Any escape messages received by the report writer from the user process program are added to the report distribution log.

Note: Report Manager includes example programs with source code. Check the source file RMSOURCE and a current PTF list.

Single values

***NONE** No program is called by a report writer.

Qualifier 1: User process program

name Specify the name of the program which is called by a report writer.

Qualifier 2: Library

***LIBL** All libraries in the thread's library list are searched.

***CURLIB** Use the current library for the job. If no library is specified as the current library for the job, QGPL is used.

name Specify the name of the library.

Delivery point (DELIVERY)

Specifies the Delivery point for the subscription.

A delivery point is a named external destination. Delivery points refine and further subdivide the destination of a report or a subscription beyond what is possible by designating output queue alone. Delivery points can have any name and any meaning desired. For an installation with a large central print facility, delivery points might be the names of bins the print operator places the printed output into. At another installation, delivery points might be the office, room, floor or building numbers to which the printed output is delivered. A delivery point can be specified on reports and on subscriptions with subscriptions having precedence.

***RPT** The delivery point is specified by the report.

***NONE** No delivery point is specified.

name Specify the name of the delivery point.

Form type (FRMTYP)

Specifies the form type on which to print the subscription.

***RPT** Print on the form type specified by the report.

***SPLF** Print on the form type specified by the report's spooled file.

name Specify the name of the form type.

Copies (COPIES)

Specifies the number of copies of the form type to print or send.

If the subscription is for a network user this is the number of copies sent on the SNDNETSPLF command.

1 One copy of the form is printed.
***SPLF** The number of copies specified by the report's spooled file are printed. These copies are in addition to copies specified on the report's subscriptions if any.
1-255 Specify the number of identical copies to print.

Start date (STRDATE)

Specifies the start date for the subscription.

A report subscription start date is the first date on which the subscription is eligible for processing by a report writer. When a report writer processes a report, it compares the date to the subscription start date to determine if actions specified by the subscriptions are taken.

***IMMED** The subscription takes effect immediately regardless of the date.
date Specify the date on which the subscription takes effect. The date must be specified in job-date format.

End date (ENDDATE)

Specifies the end date for the subscription.

A report subscription end date is the last date on which the subscription is eligible for processing by a report writer. When a report writer processes a report, it compares the date to the subscription end date to determine if actions specified by the subscriptions are taken.

***PERM** The subscription is in effect permanently.
date Specify the last date on which the subscription is in effect. The date must be specified in job-date format.

Hold (HOLD)

Specifies whether the subscription is held.

A held report subscription is ineligible for processing by a report writer. When a report writer processes a report, actions specified by held subscriptions are not taken.

Note: Reports and report subscriptions can both be held. When a report is held, report writers hold the spooled file without further processing. When a report subscription is held, report writers skip the processing specified by that subscription only. All other processing is performed.

***NO** The report subscription is not held.
***YES** The report subscription is held.

Report filter (RPTFTR)

Specifies the name of the report filter. Filter names are unique within a report.

A report filter specifies test criteria for a report that are used to reduce the number of pages delivered for a subscription. After a filter has been added to a report, it may be specified on one or more subscriptions. When a report writer processes the subscription, it tests each page of the spooled file against the filter criteria to determine if the page is selected for distribution. A page is selected when the data on the page meets the criteria specified.

All selected pages are placed in a new spooled file. If the user data (USRDTA) attribute of the original spooled file is blank, the new spooled file has the filter's name for user data.

***NONE** Specifies that no filter is used to select pages. The entire spooled file is distributed.

***UNSELECT** Specifies that the special unselect filter selects pages. This filter selects all pages from a spooled file that were not selected by any of the other filters processed by the report writer.

name Specify the name of the filter.

Omit zero page delivery (OMITZERO)

Specifies how delivery should be handled when a page filter selects zero pages from a spooled file (when no pages match a filter's criteria).

***RPT** The delivery action specified by the report determines how zero pages are delivered.

***YES** Omit the delivery when a filter selects zero pages from a spooled file.

***NO** Do not omit the delivery even though zero pages are selected from the spooled file.

Deliver status (DLVSTS)

Specifies the status a spooled file has when it is delivered.

***RPT** The delivery status specified by the report determines how spooled files are delivered.

***READY** Spooled files are delivered with a status of ready.

***HELD** Spooled files are delivered with a status of held.

Send format (SNDFMT)

Specifies the format in which the spooled file is sent to a network user.

***RPT** The send format specified by the report determines how spooled files are sent to network subscribers.

***ALLDATA** Spooled files are delivered using the Send Net Spooled File (SNDNETSPLF) command with DTAFMT(*ALLDATA).

***RCDDATA** Spooled files are delivered using the Send Net Spooled File (SNDNETSPLF) command with DTAFMT(*RCDDATA).

***EMAIL** Spooled files are delivered as Email.

Transform to perform (TRANSFORM)

Specifies the manner in which the spooled file is transformed when Report Manager is integrated with SpoolMail or Spool-a-Matic. If these products are not installed the value is ignored.

***RPT** The transform specified by the report determines how spooled files are transformed.

***TXT** Spooled files are transformed using the built in Report Manager support.

transform Specify any of the **SpoolMail** or **Spool-a-Matic** transforms.

Object (PC file) (TOOBJ)

Specifies the path name of the object (PC file) to create.

For more information on specifying path names, see *Programming > Control language > CL concepts > IBM i objects > Object naming rules* topic in the IBM i Information Center at <http://publib.boulder.ibm.com/iseri/>.
CHAR(5000)

***NONE** No object (PC file) is created.

path-name Specify up to 64 characters of path name. For example to create a file with name **abc.txt** in a directory with name **mydirectory**, specify **'/mydirectory/abc.txt'**

Report Manager provides several special values that can be used to construct dynamic object (PC file) names. When the special values are found, the associated data is blank trimmed and substituted into the path specified when it is processed. If the data associated with a special value is blank, "BLANK" is substituted. If the data associated with a special value contains characters not allowed in an object name, question marks (?) for example, the name will be invalid and the command will fail. The special values must be delimited by an underscore ('_') a period ('.') a slash ('/' or '\') or another special value (which starts with '*').

The Report Manager related special values are:

*BIN	Delivery point from the subscription CHAR(10).
*BIN8	Same as *BIN truncated to CHAR(8).
*FTR	Filter name from the subscription CHAR(10).
*FTR8	Same as *FTR truncated to CHAR(8).
*GRP	Report group from the report CHAR(10).
*GRP8	Same as *GRP truncated to CHAR(8).
*RPT	Report name CHAR(10).
*RPT8	Same as *RPT truncated to CHAR(8).
*SUB	Subscriber name CHAR(10).
*SUB8	Same as *SUB truncated to CHAR(8).
*SUBNBR	Subscription number converted to text. Length varies.

The spooled file attribute related special values are:

*ACGCDE	Accounting code CHAR(15).
*CRTSYS	System created on originally CHAR(8). This can differ from the current system's name if the spooled file was sent from another System i.
*CRTUSR	User creating originally CHAR(10). This can differ from the *JOBUSR value if the spooled file was sent from another System i.
*FILE	Spooled file name CHAR(10).
*FILE8	Same as *FILE truncated to CHAR(8).
*FORMTYPE	Spooled file form type CHAR(10). Make sure special values in the data are compatible with usage. For example few file systems allow * in a name. If the form type is *STD, the name will be invalid.
*JOBNAM	Name portion of the job containing the spooled file CHAR(10).
*JOBNAM8	Same as *JOBNAM truncated to CHAR(8).
*JOBNBR	Job number of the job containing the spooled file CHAR(6).
*JOBUSR	User portion of the job containing the spooled file CHAR(10).
*JOBUSR8	Same as *JOBUSR truncated to CHAR(8).
*OUTQ	Output queue the file is on CHAR(10).
*PAGECOUNT	Spooled file page count converted to text. CHAR(6) or more.
*PAGECNTZ	Spooled file page count converted to text with leading zeros removed. Length varies.
*PGM	Program that opened the file CHAR(10).
*PGM8	Same as *PGM truncated to CHAR(8).
*PRTTXT	Print text CHAR(30).
*SPLCDAT	Date the spooled file was open CHAR(7) CYYMMDD.
*SPLCTIM	Time the spooled file was opened CHAR(6) HHMMSS.
*SPLCCYY	Century-year portion of the date the spooled file was open CHAR(3) CYY.
*SPLCYY	Year portion of the date the spooled file was open CHAR(2) YY.
*SPLCMM	Month portion of the date the spooled file was open CHAR(2) MM.
*SPLCDD	Day portion of the date the spooled file was open CHAR(2) DD.
*SPLNBR	Spooled file number converted to text. CHAR(6).
*SPLNBRZ	Spooled file number converted to text with leading zeros removed. Length varies.
*USRDFNDDTA	User defined data CHAR(255).
*USRDFNTXT	User-defined text taken from the user profile when the spooled file was created. Add text to a user profile using the CHGUSRPRTI command CHAR(100).
*USRDTA	User data CHAR(10).

Examples

Example 1:

```
ADDRPTSUB RPT (INV310)
```

This command adds a subscription to report INV310 for the user issuing the command. The subscription is for one copy printed on the form type specified by the report. The subscription starts immediately and runs indefinitely.

Example 2:

```

ADDRPTSUB  RPT (PURCH9)  USER (QPGMR)  USRPRCPGM (RMCLNOTIFY)
            OUTQ (*NONE)
ADDRPTSUB  RPT (PURCH9)  USER (QPGMR)  SUBNBR (2)  OUTQ (PGMROFC)

```

These commands add two subscriptions to report PURCH9 on behalf of user QPGMR. The first subscription is for a user written program named RMCLNOTIFY. The second subscription delivers a copy of PURCH9 to an output queue named PGMROFC.

Note: The source code for program RMCLNOTIFY is included as an example in the source file RMSOURCE.

Example 3:

```

ADDRPTSUB  RPT (MKRPT2)  USER (*USRID)  USRID (BSMITH SEATTLE)
            OUTQ (*NONE)  FRMTYP (CUT811)  COPIES (2)

```

This command adds a subscription to report MKRPT2 on behalf of the network user BSMITH at SEATTLE. Two copies of the report on form type CUT811 are delivered using the Send Network Spooled File (SNDNETSPLF) command.

Example 4:

```

ADDRPTSUB  RPT (MKRPT2)  USER (*USRID)  USRID (BSMITH SEATTLE)
            SUBNBR (2)  OUTQ (*NONE)  TRANSFORM (*PDFLETTER)
            SNDFMT (*EMAIL)

```

This command adds a second subscription to report MKRPT2 on behalf of the network user BSMITH at SEATTLE. The spooled file is converted Adobe's Portable Document Format and delivered as email. (SNDNETSPLF) command.

Example 5:

```

ADDRPTSUB  RPT (PURCH6)  USER (QPGMR)  OUTQ (*NONE)
            TRANSFORM (*PDFLETTER)
            TOOBJ ('/REPORTS/PURCH6/*SPLCDAT.PDF')

```

This command adds a subscription that generates a PC file from the spooled file in Adobe's Portable Document Format. The PC file uses the creation date of the spooled file as its name and is placed in the REPORTS/PURCH6 directory.

Error messages

Parameter dependencies

RDM7006	When user *USRID is specified a network user must be specified.
RDM7012	A network user or a user can be specified, but not both.
RDM7007	When network user *NONE is specified user *USRID cannot be specified.
RDM7008	A subscription must have one and only one destination.
RDM7009	When the output queue is *DEV a printer device must be specified.
RDM7010	When a printer device is specified output queue *NONE or *DEV is required.
RDM7011	Start date must be before end date.

Archive Spooled File (ARCSPLF)

Where allowed to run: All environments (*ALL)

Threadsafe: No

The Archive Spooled File (ARCSPLF) command creates a spooled file archive which can be saved and restored, and from which the spooled file can be retrieved (recreated).

Parameters

Keyword	Description	Choices	Notes
FILE	Spooled file name	<i>Name</i>	Required, Positional 1
ARC	Spooled file archive	<i>Qualified object name</i>	Optional
	Qualifier 1: Spooled file archive	<i>Name</i> , *GEN	
	Qualifier 2: Library	<i>Name</i> , *CURLIB	
JOB	Job name	Single values: <i>_</i> Other values: <i>Qualified job name</i>	Optional
	Qualifier 1: Job name	<i>Name</i>	
	Qualifier 2: User	<i>Name</i>	
	Qualifier 3: Number	000000-999999	
SPLNBR	Spooled file number	1-999999, *ONLY , *LAST	Optional

Spooled file name (FILE)

Specifies the name of the spooled file to process. CHAR(10)

This is a required parameter.

name Specify the name of the spooled file.

Spooled file archive (ARC)

Specifies the name of the archive that contains the spooled file.

Element 1: Spooled file archive

***GEN** Generate the archive name from the supplied FILE, JOB, and SPLNBR parameters.

name Specify the name of the archive.

Qualifier 2: Library

***CURLIB** Use the current library for the job. If no library is specified as the current library for the job, QGPL is used.

name Specify the name of the library.

Job name (JOB)

Specifies the job that contains the spooled file.

Single values

_ The job that issued the command.

Qualifier 1: Job name

name Specify the name of the job. CHAR(10)

Qualifier 2: User

name Specify the name that identifies the user profile under which the job is run. CHAR(10)

Qualifier 3: Number

000000-999999 Specify the system assigned job number. CHAR(6)

Spoiled file number (SPLNBR)

Specifies the number of the spoiled file. INT(4)

*LAST	The highest numbered spoiled file with the specified file name is used.
*ONLY	The number of the only spoiled file with the specified file name is used.
1-999999	Specify the number of the spoiled file.

Examples

Example 1:

```
ARCSPLF FILE(QSYSPRT)
```

This command archives the last spoiled file named QSYSPRT. The current job is searched to locate the file. The archive is placed in the job's *CURLIB.

Example 2:

```
ARCSPLF FILE(QPQUPRFIL) ARC(QGPL/*GEN) SPLNBR(3)
```

The file named QPQUPRFIL, which is spoiled file number 3 in the job executing this command, is archived. The archive is placed in library QGPL.

Change Banner Definition (CHGBNRDFN)

Where allowed to run: All environments (*ALL)

Threadsafe: No

The Change Banner Definition (CHGBNRDFN) command changes the size, appearance, arrangement and selection of elements specified in a banner definition for printing by the Report Manager supplied separator programs *BANNER and *PACKSLIP.

A Banner definition is a system object used by the Report Manager supplied separator programs *BANNER and *PACKSLIP. A banner definition describes the contents and appearance of separator pages printed between spooled files.

The *BANNER separator print program is supplied by Report Manager. It creates separators with large block letter print and provides subscription information when available.

The *PACKSLIP separator print program is supplied by Report Manager. It creates a table of contents style listing of the spooled files printed in a package or bundle. In addition, the *PACKSLIP generates separators between individual spooled files based on the FILESEP parameter specified for the report writer. If the FILESEP parameter is not zero, separators between individual spooled files are created using the *BANNER separator program.

Parameters

Keyword	Description	Choices	Notes
BNRDFN	Banner Definition	<i>Qualifier list</i>	Optional, Key, Positional 1
	Qualifier 1: Banner Definition	*PACKSLIP, * BANNER	
PAGELAYOUT	Page layout	Single values: * SAME Other values (up to 32 repetitions): <i>Element list</i>	Optional, Positional 2
	Element 1: Item name	*ACGCDE, *CONSTANT, *FILE, *FILTER, *JOB DAT, *JOB DATTIM, *JOB TIM, *JOB NAM, *JOB NBR, *PACK DATA, *PAGE BAR, *PAGE PAD, *PGM, *PR TOPT, *PR TOPT DLV, *PR TOPT FRM, *PR TOPT GRP, *PR TOPT USR, *PR TTX T, *RPT, *RPT FILE, *SUB, *SUB USR DTA, *SYS NAM, *TITLE BAR, *USR, *USR DTA, *WHITE	
	Element 2: Initial scale	0-7	
	Element 3: Compress order	1-32	
	Element 4: Additional space after	0-4	
	Element 5: Required item	* NO , *YES	
TITLE	Title	<i>Character value</i> , * SAME , *BLANK	Optional, Positional 3

Banner Definition (BNRDFN)

Specifies the name of the banner definition.

- ***BANNER** Specifies the banner definition for the Report Manager supplied separator print program *BANNER.
- ***PACKSLIP** Specifies the banner definition for the Report Manager supplied separator print program *PACKSLIP.

Page layout (PAGELAYOUT)

Page layout specifies the names, parameters and arrangement of the separator page items that are included when a separator page is printed from the banner definition. A page layout can be made up of up to 32 items. The order in which items are specified is the order in which they are placed on the separator page. Each page item is made up of 5 elements:

- Item name

Specifies the name of the separator item to be printed. The meaning of the other four elements can change depending on the item named here.

- Initial scale

For most items this is the multiplication factor for printing block letters. Scale of 1 means the smallest block letters are used. A scale of 2 doubles the size of block letters used, etc. When 0 is specified, block letters are not used and the item is simply printed.

For item names that are not represented with block letters, Initial scale specifies the initial size of the item usually in lines.

- Compress order

Specifies the order in which the item is compressed. When all of the items in the page layout are assembled, they may exceed the size of the particular form type being printed. If so, the page is compressed to fit. First, the scale of all items is reduced in turn. If the separator still does not fit, space between items is removed in turn. As a last resort items are removed from the page in turn.

Each item in the page layout must specify a unique compress order between 1 and the number of items on the page. The item with compress order 1 is the first to be reduced in scale, the first to have its space after removed, and the first to be removed from the page.

- Additional space after

Specifies the number of additional lines to space after the item is printed.

- Required item

Specifies if the item is always printed even if this causes the separator to spill over onto additional pages.

Single values

***SAME** The value is not changed.

Element 1: Item name

***ACGCDE** The accounting code used to log the resources for creating the spooled file is printed in block letters.

***CONSTANT** The constant value **.Report Manager** is printed starting at position 1. This may be useful as a trigger for printer command processing.

***FILE** The spooled file name is printed in block letters.

***FILTER** The report filter used to create the spooled file is printed in block letters.

***JOB DAT** The date the job that created the spooled file started execution is printed in block letters. This value is not available if the job is no longer in the system.

***JOB DATTIM** The date and time the job that created the spooled file started execution is printed in block letters. These values are not available if the job is no longer in the system.

***JOB TIM** The time the job that created the spooled file started execution is printed in block letters. This value is not available if the job is no longer in the system.

***JOB NAM** The name of the job that created the spooled file is printed in block letters.

***JOB NBR** The number of the job that created the spooled file is printed in block letters.

***PACKDATA** A list of the spooled files that follow the packing slip is printed. Initial scale is ignored by ***PACKDATA** and the number of lines printed depends on the number of spooled files that are going to be printed and headings for the data.

Note: Intended for use only with the separator print program ***PACKSLIP**.

***PAGEBAR** A bar is printed as an aid in locating the separator page. The bar is generated by repeating a letter of the alphabet the length of the page and repeating this line the number of times specified by the initial scale. On successive separators, the next letter of the alphabet is used. The bar also includes the number of pages and the number of copies of the spooled file being printed.

***PAGEPAD** This item represents any and all lines left over after all of the other items have been fitted to the page. When

***PAGEPAD** is not specified these lines appear after the last item in the layout. ***PAGEPAD** moves this padding to another point in the layout, allowing other items to be printed at the bottom of the page. When ***PAGEPAD** is specified it must have the highest (largest numerically) compress order in the layout. Initial scale is ignored.

*PGM	The name of the program that opened the spooled file is printed in block letters.
*PRTOPT	The name of the currently active print option the report writer is processing is printed in block letters. If a delivery point was specified on the writer's print options then *PRTOPT acts as *PRTOPTDLV , if a user was specified then *PRTOPT acts as *PRTUSR , etc.
*PRTOPTDLV	The name of the delivery point specified on the print options the report writer is processing is printed in block letters. If *POINTS was specified then the current delivery point is printed.
*PRTOPTFRM	The name of the form type specified on the print options the report writer is processing is printed in block letters. If *FORMS was specified then the current form type is printed.
*PRTOPTGRP	The name of the report group specified on the print options the report writer is processing is printed in block letters. If *GROUPS was specified then the current report group is printed.
*PRTOPTUSR	The name of the user (recipient) specified on the print options the report writer is processing is printed in block letters. If *USERS was specified then the current user (recipient) is printed.
*PRTTXT	The print text of the job that created the spooled file is printed in block letters.
*RPT	The name of the report is printed in block letters.
*RPTFILE	The name of the report is printed in block letters. If the name of the report is *NONE , the spooled file name is printed.
*SUB	A list of the subscribers who receive the spooled file that follows the banner is printed. Initial scale is ignored by *SUB and the number of lines printed depends on the number of subscriptions plus headings for the subscription data.
*SUBUSRDTA	A list of the subscribers who receive the spooled file that follows the banner is printed. Initial scale is ignored by *SUBUSRDTA and the number of lines printed depends on the number of subscriptions plus headings for the subscription data. If there are no subscriptions, the user data from the spooled file is printed instead.
*SYSNAM	The name of the system is printed in block letters.
*TITLEBAR	A bar is printed as an aid in locating the separator page. The bar is generated by repeating a letter of the alphabet the length of the page and repeating this line the number of times specified by the initial scale. On successive separators, the next letter of the alphabet is used. The bar also includes the data entered on the Title (TITLE) parameter.
*USR	The name of the user creating the spooled file is printed in block letters.
*USRDTA	The user data from the spooled file is printed in block letters.
*WHITE	The number of blank lines specified for initial scale are printed.

Element 2: Initial scale

0-7 Specify the initial scale of the item.

Element 3: Compress order

1-32 Specify the compression order for the item.

Element 4: Additional space after

0-4 Specify the number of lines to space after the item.

Element 5: Required item

***NO** The element is not required and may be removed if needed.

***YES** The element is required and must be included.

Title (TITLE)

Specifies the title to be displayed in the title bar (***TITLEBAR**) page element.

***SAME** The value is not changed.

***BLANK** No title is specified.

character-value Specify up to 40 characters enclosed in apostrophes.

Examples

Example 1:

```
CHGBNRDFN  BNRDFN (*BANNER)
            TITLE('Report Manager - Gumbo Software Inc')
```

This command changes the title used by ***BANNER** to that shipped with Report Manager.

Example 2:

```
CHGBNRDFN  BNRDFN (*BANNER)
            PAGELAYOUT ((*TITLEBAR 3 4 2) (*USR 2 1 2)
            (*RPTFILE 2 6 2) (*JOBNAM 2 2 2) (*SUBUSRDTA 2 5 2)
            (*PAGEPAD 0 7 0) (*PAGEBAR 3 3 0))
```

This command changes the definition used by ***BANNER** to that shipped with Report Manager. After the change, separators printed are similar to the following.

Figure: Separator Page And RHELLO Output

```

Gumbo Software, Inc.
Report Manager Quick Start Example
4/01/11 17:34:52

Hello world!

AAAAAAAAAAAAAAAAAAAAAAAAAAAAAAAAAAAAAAAAAAAAAAAAAAAAAAAAAAAA
AAA  Report Manager - Gumbo Software Inc.  AAA
AAAAAAAAAAAAAAAAAAAAAAAAAAAAAAAAAAAAAAAAAAAAAAAAAAAAAAAAAAAA
                QPGMR
RRRR  M  M  PPPP  RRRR  TTTT  FFFF
R  R  MM MM  P  P  R  R  T  F
R  R  M M M  P  P  R  R  T  F
RRRR  M M M  PPPP  RRRR  T  FFFF
R  R  M  M  P  R  R  T  F
R  R  M  M  P  R  R  T  F
R  R  M  M  P  R  R  T  F
                DSP03
EEEE  X  X  AAA  M  M  PPPP  L  EEEEE
E  X  X  A  A  MM MM  P  P  L  E
E  X  X  A  A  M M M  P  P  L  E
EEEE  X  A  A  M M M  PPPP  L  EEEE
E  X  X  AAAAA  M  M  P  L  E
E  X  X  A  A  M  M  P  L  E
EEEE  X  X  A  A  M  M  P  LLLLL  EEEEE

AAAAAAAAAAAAAAAAAAAAAAAAAAAAAAAAAAAAAAAAAAAAAAAAAAAAAAAAAAAA
AAAAAAAAAAAA  Pages: 1 Copies: 1  AAAAAAAAAA
AAAAAAAAAAAAAAAAAAAAAAAAAAAAAAAAAAAAAAAAAAAAAAAAAAAAAAAAAAAA
```

Change Form Type (CHGFRMTYP)

Where allowed to run: All environments (*ALL)

Threadsafe: No

The Change Form Type (CHGFRMTYP) command changes a form type.

Parameters

Keyword	Description	Choices	Notes
FRMTYP	Form type	<i>Character value</i>	Required, Key, Positional 1
PHYCOPIES	Physical copies	1-9, <u>*SAME</u>	Optional, Positional 2
TEXT	Text 'description'	<i>Character value</i> , <u>*SAME</u> , *BLANK	Optional, Positional 3

Form type (FRMTYP)

Specifies the name of the form type.

This is a required parameter.

name Specify the name of the form type.

Physical copies (PHYCOPIES)

Specifies the physical copies produced by the form type.

***SAME** The value is not changed.

1-9 Specify the number of copies produced ranging from 1 to 9.

Text 'description' (TEXT)

Specifies text that provides a brief description.

***SAME** The value is not changed.

***BLANK** No text is specified.

character-value Specify up to 50 characters of text enclosed in apostrophes.

Examples

Example 1:

```
CHGFRMTYP FRMTYP (CUTSHEET) PHYCOPIES (1)
```

This command changes a form type named CUTSHEET. The number of deliverable copies produced by one printing of the form is changed to 1.

Example 2:

```
CHGFRMTYP FRMTYP (SIXPLYWIDE) PHYCOPIES (6)
```

This command changes a form type named SIXPLYWIDE. The number of deliverable copies produced by one printing of the form is changed to 6.

Change Report Manager Authorization (CHGRM1AUT)

Where allowed to run: All environments (*ALL)

Threadsafe: No

The Change Report Manager Authorization (CHGRM1AUT) command changes the authorization code for Report Manager. The command is used to extend a demonstration period or to permanently authorize Report Manager for a system or a partition.

Parameters

Keyword	Description	Choices	Notes
AUTH	Authorization code	<i>Hexadecimal value</i>	Required, Positional 1
EXPDAT	Expiration date (CCYYMMDD)	<i>Character value, <u>*NONE</u></i>	Optional, Positional 2
LICTYP	License type	<i><u>*SYS</u>, *LPAR</i>	Optional, Positional 3
PRCMAX	Processor maximum capacity	<i>Decimal number</i>	Optional, Positional 4

Authorization code (AUTH)

Specifies the authorization code to use. The authorization code is 8 hex digits that may be entered in upper or lower case.

This is a required parameter.

hexadecimal-value Specify the case insensitive authorization code.

Expiration date (CCYYMMDD) (EXPDAT)

Specifies the date on which the authorization expires.

***NONE** The authorization is permanent.
date The date on which the authorization expires in CCYYMMDD format.

License type (LICTYP)

Specifies the type of license that is authorized.

***SYS** The authorization is for a system wide license, which enables any and all partitions on the system but is specific to the processor group.

Note: The authorization code must be entered in each partition.

***LPAR** The license is specific to one of the partitions on the system and specific to a number of processors within the partition. A partition license must be entered in the partition for which it is intended.

Processor maximum capacity (PRCMAX)

Specifies the maximum processor capacity for which the partition is licensed. The value is expressed in terms of processors where 1.00 is 100% of a processor's capacity or the same as 1 processor, .50 is 50% of a processor's capacity or .5 processors, 2.00 is 200% of a processor's capacity or 2 processors, etc.

decimal-number Specify the maximum processor capacity.

Examples

Example 1:

```
CHGRM1AUT AUTH(01234567)
```

This command changes the authorization code to a permanent system wide license code.

Example 2:

```
CHGRM1AUT AUTH(01234567) LICTYP(*LPAR) PRCMAX(1.3)
```

This command changes the authorization code to a permanent partition only license code for 1.3 processors in the current partition.

Change Report Manager Default (CHGRM1DFT)

Where allowed to run: All environments (*ALL)

Threadsafe: No

The Change Report Manager Default (CHGRM1DFT) command changes values used by Report Manager to control processing and other activities.

Parameters

Keyword	Description	Choices	Notes
SPLFWAIT	Spooled file wait (seconds)	1-32767, <u>*SAME</u>	Optional, Positional 1
SPLFLMT	Spooled file count limit	1-32767, <u>*SAME</u>	Optional, Positional 2
LOGSIZE	Log size (days)	1-32767, <u>*SAME</u>	Optional, Positional 3
VFYUSRPRF	Verify subscriber	<u>*SAME</u> , *YES, *NO	Optional, Positional 4
SAVOUTQ	Output queue for saved spooled	<u>*SAME</u> , *SOURCE, *INTERNAL	Optional, Positional 5
LOGPRGPGM	Log purge program	Single values: <u>*SAME</u> , *NONE Other values: <i>Qualified object name</i>	Optional, Positional 6
	Qualifier 1: Log purge program	<i>Name</i>	
	Qualifier 2: Library	<i>Name</i> , <u>*LIBL</u> , *CURLIB	
ARCRSTPGM	Archive restore program	Single values: <u>*SAME</u> , *NONE Other values: <i>Qualified object name</i>	Optional, Positional 7
	Qualifier 1: Archive restore program	<i>Name</i>	
	Qualifier 2: Library	<i>Name</i> , <u>*LIBL</u> , *CURLIB	
VFYFRMTYP	Verify form type	<u>*SAME</u> , *YES, *NO	Optional, Positional 8
SIXSIC	Spool Index SCS Control	*ORDINAL, *RELATIVE, <u>*SAME</u> , 0, 64, -1	Optional, Positional 9

Spooled file wait (seconds) (SPLFWAIT)

Specifies the spooled file wait time in seconds.

The Spooled file wait (seconds) parameter determines the number of seconds that a report writer waits for the arrival of a spooled file before timing out and performing idle state cleanup functions. Cleanup functions include removing messages from the writer's job log, closing open files, shutting down active programs, and purging report distribution log entries. In addition, if the number of spooled files in the writer job exceeds the limit set by spooled file count limit, the writer job is restarted. Cleanup functions are not performed on subsequent time outs unless spooled files have arrived on the output queue and been processed since the last time out.

***SAME** The value is not changed.

1-32767 Specify a number of seconds to wait. The value shipped with the software is 1800 seconds (30 minutes).

Spooled file count limit (SPLFLMT)

Specifies the report writer job spooled file count limit.

The Spooled file count limit parameter determines the number of spooled files a report writer can create before the writer starts looking for an opportunity to restart the job. Report writers create spooled files when they create separator pages and when they replicate spooled files. IBM i stores information about each spooled file created by a job as part of that job. As the number of spooled files increases, so does the size of several internal job structures. Left unbounded, the size growth can degrade job performance, and ultimately affect machine performance. After a report writer has created the number of spooled files specified by this parameter, it uses the next idle period to submit a new copy of itself, resetting the spooled file count to zero. In this way report writers can run indefinitely. Since the report writer waits for the first idle period to resubmit itself, the actual number of spooled files in the writer job can exceed the limit set by this parameter.

***SAME** The value is not changed.
1-32767 Specify a number of spooled files. The value shipped with the software is 4,096.

Log size (days) (LOGSIZE)

Specifies the report distribution log size.

Log size specifies the minimum number of days that an entry should remain in the report distribution log. The report distribution log is purged of old entries once a day, or after a change to this parameter, by the first report writer to perform cleanup functions during an idle state. If no report writers are active, log entries may remain in the report distribution log for more than the specified number of days.

Purged records are deleted from the underlying physical files which specify *YES for the "Reuse deleted records" parameter. Space can be recovered by reorganizing Report Manager's physical files.

***SAME** The value is not changed.
1-32767 Specify the number of days an entry should remain in the report distribution log. The value shipped with the software is 32 days.

Verify subscriber (VFYUSRPRF)

Verify subscriber specifies whether or not the Add Report Subscription (ADDRPTSUB) and Change Report Subscription (CHGRPTSUB) commands check to insure that subscriber names are also valid IBM i user profile names or network users. Changing the Verify subscriber parameter does not affect subscriptions that already exist for reports.

Note: *USRPRF is a special value for several parameters such as output queue (OUTQ). When a subscriber's name is not a user profile name, do not use the *USRPRF special value.

***SAME** The value is not changed.
***YES** Subscribers must have valid IBM i user profiles or be a valid network user.
***NO** Subscribers are not required to have user profiles or be a network user.

Output queue for saved spooled files (SAVOUTQ)

Output queue for saved spooled files specifies handling for spooled files that have a status of SAV after printing by a report writer.

***SAME** The value is not changed.
***SOURCE** Saved spooled files reside on the output queue from which they were printed.
***INTERNAL** Saved spooled files reside on the report writer's internal output queue. Use this value for compatibility with earlier releases of the software.

Log purge program (LOGPRGPGM)

A log purge program is a program that is given control by a report writer during the daily report distribution log purge processing.

Note: Report Manager includes example programs with source code. Check the source file RMSOURCE and a current PTF list.

Single values

***SAME** The value is not changed.
***NONE** No program is called by a report writer.

Qualifier 1: Program

name Specify the name of the program.

Qualifier 2: Library

*LIBL	All libraries in the thread's library list are searched.
*CURLIB	Use the current library for the job. If no library is specified as the current library for the job, QGPL is used.
name	Specify the name of the library.

Archive restore program (ARCRSTPGM)

An archive restore program is called when the Retrieve Spooled File (RTVSPLF) command cannot locate a spooled file's archive. The program is responsible for restoring the archive from offline media.

Note: Report Manager includes example programs with source code. Check the source file RMSOURCE and a current PTF list.

Single values

*SAME	The value is not changed.
*NONE	No program is called to restore archives.

Qualifier 1: Program

name	Specify the name of the program which is called to restore archives.
-------------	--

Qualifier 2: Library

*LIBL	All libraries in the thread's library list are searched.
*CURLIB	Use the current library for the job. If no library is specified as the current library for the job, QGPL is used.
name	Specify the name of the library.

Verify form type (VFYFRMTYP)

Verify form type specifies whether or not the Add Report Subscription (ADDRPTSUB), Change Report Subscription (CHGRPTSUB), Create Report (CRTRPT) and Change Report (CHGRPT) commands check to insure that the form type is known to Report Manager. Changing the Verify form type parameter does not affect subscriptions or reports that already exist.

*SAME	The value is not changed.
*YES	Form types are checked.
*NO	Form type is not checked.

Spool Index SCS Control (SIXSIC)

Specifies the spooled file indexing method for *SCS files in the presence of lines per inch (LPI) changes or font changes within a page. Spooled file indexing occurs when line and position values are required to process a request. Examples are filtering, or specifying page data. This setting can only affect the determination of line numbers if the spooled file contains *SCS and if the LPI or font changes within a page.

*SAME	The value is not changed.
*ORDINAL	This is the recommended value. Line numbers and position numbers are calculated using a deterministic, repeatable method that typically returns line and position values as they were specified in the DDS for the printer file.
*RELATIVE	This value gives the original indexing behavior. The method returns line and position numbers that may vary from page to page for data that otherwise appears in the same position. The variance depends on the data's position relative to preceding data on the page.

Examples

Example 1:

```
CHGRM1DFT LOGSIZE (60)
```

This command changes the minimum number of days a report distribution log entry is kept on the system to 60.

Example 2:

```
CHGRM1DFT  SPLFLMT(1024)
```

This command changes to 1024 the number of spooled files created by a report writer before it is automatically restarted.

Change Report (CHGRPT)

Where allowed to run: All environments (*ALL)

Threadsafe: No

The Change Report (CHGRPT) command changes an existing report. Any attribute of a report can be changed, except for the authority attribute, subscriptions, filters, and hold status. Refer to the Revoke Object Authority (RVKOBJAUT) command and Grant Object Authority (GRTOBJAUT) command for more information on changing object authorizations. Refer to the Change Report Subscription (CHGRPTSUB) command for information on changing subscriptions. Refer to the Change Report Filter (CHGRPTFTR) command for information on changing filters. Refer to the Hold Report (HLDRPT) command and Release Report (RLSRPT) command for information on holding and releasing reports.

A report is a system object containing information used by Report Manager to identify and distribute related spooled files.

- The identification information includes:
 - Selection criteria which are compared to the attributes of spooled files by Report Manager to determine which individual spooled files are an edition of the report.
 - An abstract which describes the purpose and contents of a report.
 - A subject to be used when generating email.
- The distribution information includes:
 - Subscriptions which specify report recipients and method of delivery.
 - Report filters which specify page selection criteria for decollating.
 - Specifications for printing such as defaults for form type, copies, and output queue.
 - The name of a user process program to handle unique processing needs.
 - The name of a library to receive archives containing the report's spooled files.
 - Specifications for other processing such as delivery point, hold status, report group, transform, send format, and whether or not subscriptions are allowed.

Much of the distribution information can be specified on the report and overridden by the values specified on individual subscriptions.

Parameters

Keyword	Description	Choices	Notes
RPT	Report Qualifier 1: Report Qualifier 2: Library	<i>Qualified object name</i> <i>Name</i> <i>Name, *LIBL, *CURLIB</i>	Required, Key, Positional 1
FRMTYP	Form type	<i>Character value, *SAME, *SPLF</i>	Optional, Positional 2
COPIES	Copies	1-255, <u>*SAME</u> , *SPLF, *RPTSUB	Optional, Positional 3
ALWRPTSUB	Allow report subscriptions	<u>*SAME</u> , *NO, *YES	Optional, Positional 4
GROUP	Report group	<i>Name, *SAME, *NONE</i>	Optional, Positional 5
DELIVERY	Delivery point	<i>Character value, *SAME, *NONE</i>	Optional, Positional 6
TEXT	Text 'description'	<i>Character value, *SAME, *BLANK</i>	Optional, Positional 7
OMITZERO	Omit zero page delivery	<u>*SAME</u> , *YES, *NO	Optional, Positional 8
DLVSTS	Deliver status	<u>*SAME</u> , *READY, *HELD	Optional, Positional 9
SNDFMT	Send format	<u>*SAME</u> , *EMAIL, *ALLDATA, *RCDDATA	Optional, Positional 10
SUBJECT	Subject	<i>Character value, *SAME, *DEFAULT, *RPTFTR, *ACGCDE, *PRTTXT, *USRDATA, *NONE</i>	Optional, Positional 11
TRANSFORM	Transform to perform	<i>Character value, *SAME, *TXT, *PDFLETTER, *PDFLEGAL, *PDFA4,</i>	Optional,

		*RTFLETTER, *RTFLEGAL, *RTFA4	Positional 12
MSGUSEABST	Use abstract as message	* SAME , *NO, *YES	Optional, Positional 13
OUTQ	Destination output queue	Single values: * SAME , *WTR, *DEV, *USRPRF, *JOB Other values: <i>Qualified object name</i>	Optional, Positional 14
	Qualifier 1: Destination output queue	<i>Name</i>	
	Qualifier 2: Library	<i>Name</i> , * LIBL , *CURLIB	
PRTDEV	Printer device	<i>Name</i> , * SAME , *SYSVAL, *USRPRF, *NONE	Optional, Positional 15
SELECT	Select spooled files with	<i>Element list</i>	Optional, Positional 16
	Element 1: Program that opened file	Single values: * SAME , *RPT, *ALL, *BLANK Other values: <i>Qualified object name</i>	
	Qualifier 1: Program that opened file	<i>Generic name, name</i>	
	Qualifier 2: Library	<i>Name</i> , * ALL	
	Element 2: Spooled file name	<i>Generic name, name</i> , * SAME , *ALL	
	Element 3: User data	<i>Character value</i> , * SAME , *ALL	
	Element 4: Job name	<i>Generic name, name</i> , * SAME , *ALL	
	Element 5: Form type	<i>Character value</i> , * SAME , *ALL	
	Element 6: User	<i>Generic name, name</i> , * SAME , *ALL	
	Element 7: Accounting code	<i>Character value</i> , * SAME , *ALL	
	Element 8: Print text	<i>Character value</i> , * SAME , *ALL	
	Element 9: Printer device type	* SAME , *ALL, *AFPDS, *AFPDLINE, *IPDS, *LINE, *SCS, *USERASCII	
	Element 10: Output queue	Single values: * SAME , *ALL Other values: <i>Qualified object name</i>	
	Qualifier 1: Output queue	<i>Name</i>	
	Qualifier 2: Library	<i>Name</i> , * ALL	
	Element 11: Device file	Single values: * SAME , *ALL Other values: <i>Qualified object name</i>	
	Qualifier 1: Device file	<i>Name</i>	
	Qualifier 2: Library	<i>Name</i> , * ALL	
	Element 12: Front overlay	Single values: * SAME , *ALL Other values: <i>Qualified object name</i>	
	Qualifier 1: Front overlay	<i>Name</i>	
Qualifier 2: Library	<i>Name</i> , * ALL		
Element 13: Back overlay	Single values: * SAME , *ALL Other values: <i>Qualified object name</i>		
Qualifier 1: Back overlay	<i>Name</i>		
Qualifier 2: Library	<i>Name</i> , * ALL		
Element 14: Form definition	Single values: * SAME , *ALL Other values: <i>Qualified object name</i>		
Qualifier 1: Form definition	<i>Name</i>		
Qualifier 2: Library	<i>Name</i> , * ALL		
Element 15: Page definition	Single values: * SAME , *ALL Other values: <i>Qualified object name</i>		
Qualifier 1: Page definition	<i>Name</i>		
Qualifier 2: Library	<i>Name</i> , * ALL		
Element 16: Minimum pages	<i>Integer</i> , * SAME , *NOMIN		
Element 17: Maximum pages	<i>Integer</i> , * SAME , *NOMAX		
Element 18: Spooled file number	<i>Integer</i> , * SAME , *ALL		
SELECTSEQ	Selection processing sequence	1-9999, * SAME	Optional, Positional 17
USRPRCPGM	User process program	Single values: * SAME , *NONE Other values: <i>Qualified object name</i>	Optional, Positional 18
	Qualifier 1: User process program	<i>Name</i>	
	Qualifier 2: Library	<i>Name</i> , * LIBL , *CURLIB	
ABSTRACT	Abstract	<i>Character value</i> , * SAME	Optional, Positional 19
ARCLIB	Library to receive archive	<i>Name</i> , * SAME , *NONE, *WTR	Optional, Positional 20

Report (RPT)

Specifies the name of the report and the library where it resides.

This is a required parameter.

Qualifier 1: Report

name Specify the name of the report.

Qualifier 2: Library

***LIBL** All libraries in the thread's library list are searched.

***CURLIB** Use the current library for the job. If no library is specified as the current library for the job, QGPL is used.

name Specify the name of the library.

Form type (FRMTYP)

Specifies the form type on which to print the report. The form type may be overridden by a subscription.

***SAME** The value is not changed.

***SPLF** Print on the form type specified by the report's spooled file.

name Specify the name of the form type.

Copies (COPIES)

Specifies the number of copies of the form type to print or send.

This is the number of copies that print in addition to those specified on subscriptions. If there are no subscriptions, this is the number of copies to print.

***SAME** The value is not changed.

***SPLF** The number of copies specified by the report's spooled file are printed. These copies are in addition to copies specified on the report's subscriptions if any.

***RPTSUB** The number of copies specified by the report's subscriptions are printed. The copies parameter specified on the spooled file is ignored. If the report does not have any subscriptions ***RPTSUB** is treated as ***SPLF**.

1-255 Specify the number of identical copies to print.

Allow report subscriptions (ALWRPTSUB)

The Allow report subscriptions parameter determines whether or not the report can have subscriptions added to it by the Add Report Subscription (ADDRPTSUB) command. Changing the Allow report subscriptions parameter does not affect subscriptions that already exist for the report.

***SAME** The value is not changed.

***YES** Subscriptions can be added to this report.

***NO** Subscriptions cannot be added to this report.

Report group (GROUP)

Specifies the report's Report group.

A report group is a collection of related or similar reports. Report groups provide a means of segregating printed output. Report groups can have any name and any meaning desired. For an installation with many applications, report groups might be the name of the application the report belongs to such as "INVENTORY" or "ACCOUNTING". At another installation, report groups might be the name of the process that produces the report such as "MONTHEND" or "NIGHTLY".

***SAME** The value is not changed.

***NONE** No report group is specified.

name Specify the name of the report group.

Delivery point (DELIVERY)

Specifies the Delivery point for the report.

A delivery point is a named external destination. Delivery points refine and further subdivide the destination of a report or a subscription beyond what is possible by designating output queue alone. Delivery points can have any name and any meaning desired. For an installation with a large central print facility, delivery points might be the names of bins the print operator places the printed output into. At another installation, delivery points might be the office, room, floor or building numbers to which the printed output is delivered. A delivery point can be specified on reports and on subscriptions with subscriptions having precedence.

*SAME	The value is not changed.
*NONE	No delivery point is specified.
name	Specify the name of the delivery point.

Text 'description' (TEXT)

Specifies text that provides a brief description.

*SAME	The value is not changed.
*BLANK	No text is specified.
character-value	Specify up to 50 characters of text enclosed in apostrophes.

Omit zero page delivery (OMITZERO)

Specifies how delivery should be handled when a page filter selects zero pages from a spooled file (when no pages match a filter's criteria).

*SAME	The value is not changed.
*YES	Omit the delivery when a filter selects zero pages from a spooled file.
*NO	Do not omit the delivery even though zero pages are selected from the spooled file.

Deliver status (DLVSTS)

Specifies the status a spooled file has when it is delivered.

*SAME	The value is not changed.
*READY	Spooled files are delivered with a status of ready.
*HELD	Spooled files are delivered with a status of held.

Send format (SNDFMT)

Specifies the format in which the spooled file is sent to a network user.

*SAME	The value is not changed.
*ALLDATA	Spooled files are delivered using the Send Net Spooled File (SNDNETSPLF) command with DTAFMT(*ALLDATA).
*RCDDATA	Spooled files are delivered using the Send Net Spooled File (SNDNETSPLF) command with DTAFMT(*RCDDATA).
*EMAIL	Spooled files are delivered as Email.

Subject (SUBJECT)

Specifies the subject for email generated by subscriptions to the report.

*SAME	The value is not changed.
*DEFAULT	The subject of the email is generated from spooled file attributes.
*RPTFTR	The subject of the email is the report's name followed by the filter's name.
*ACGCDE	The subject of the email is the accounting code of the job that created the spooled file.

*PRTTXT	The subject of the email is the spooled file's print text attribute.
*USRDTA	The subject of the email is the spooled file's user data attribute.
*NONE	No subject is included in the email.
character-value	Specify the subject of the email.

Transform to perform (TRANSFORM)

Specifies the manner in which the spooled file is transformed when Report Manager is integrated with SpoolMail or Spool-a-Matic. If these products are not installed the value is ignored.

*SAME	The value is not changed.
*TXT	Spooled files are transformed using the built in Report Manager support.
transform	Specify any of the SpoolMail or Spool-a-Matic transforms.

Use abstract as message (MSGUSEABST)

Specifies that the report's abstract should be used as the body of generated email messages.

*SAME	The value is not changed.
*NO	Do not use the report's abstract as the message, a default is generated.
*YES	Use the report's abstract as the message.

Destination output queue (OUTQ)

Specifies the name of an output queue to which spooled files are delivered by a report writer. This parameter follows the rules of the OUTQ parameter of printer device files, job descriptions, user profiles and display devices outlined in *iSeries Printer Device Programming SC41-5713*.

Single values

*SAME	The value is not changed.
*WTR	The destination is determined at the time a report writer is delivering spooled files. If the report writer is started with a printer device specified on the DEV parameter then the spooled file is printed. If DEV(*NONE) is specified when the report writer is started then the default destination queue (DFTOUTQ) parameter is used as the destination.
*DEV	The output queue associated with the printer device is used.
*USRPRF	The output queue specified in the user profile of the creator of the spooled file is used.
*JOB	The output queue of the job that created the spooled file is used.

Qualifier 1: Output queue

name	Specify the name of the output queue.
-------------	---------------------------------------

Qualifier 2: Library

*LIBL	All libraries in the thread's library list are searched.
*CURLIB	Use the current library for the job. If no library is specified as the current library for the job, QGPL is used.
name	Specify the name of the library.

Printer device (PRTDEV)

Specifies the name of a printer device description to which spooled files are delivered by a report writer. This parameter follows the rules of the DEV parameter of printer device files, job descriptions, user profiles and display devices outlined in *iSeries Printer Device Programming SC41-5713*.

*SAME	The value is not changed.
*NONE	Spooled files are not delivered to a printer device.
*SYSVAL	The printer device named in the QPRTDEV system value is used.
*USRPRF	The printer device specified in the user profile of the creator of the spooled file is used.
name	Specify the name of the printer device to use.

Select spooled files with (SELECT)

Specifies the selection criteria which identify the report. Selection criteria consist of 18 elements.

The select spooled file parameter is a set of criterion that allows a report writer to identify report editions. It is made up of 18 elements which are matched against the corresponding attributes of a spooled file. A spooled file whose attributes match all of the selection criteria is identified as an edition of the report.

Element 1: Program that opened file

Single values	*SAME	The value is not changed.
	*RPT	Only spooled files created by a program with the same name as the report are selected. When the program name is compared the program library is not considered.
	*ALL	Select spooled files with all values. This criterion does not distinguish editions of the report.
	*BLANK	Spooled files whose creating program name is left blank are selected. Many IBM programs such as query omit the program name.
Qualifier 1: Program	generic-name	Specify a generic name. Spooled files whose creating program name begins with the specified characters are selected.
	name	Specify the program name that creates editions of the report.
Qualifier 2: Library	*ALL	Select spooled files with all values. The library name does not distinguish editions of the report.
	name	Specify the qualifying library name that distinguishes editions of the report.

Element 2: Spooled file name

*SAME	The value is not changed.
*ALL	Select spooled files with all values. This criterion does not distinguish editions of the report.
name	Specify the spooled file name that identifies editions of the report.
generic-name	Specify a generic name. Spooled files whose name begins with the specified characters are selected.

Element 3: User data

*SAME	The value is not changed.
*ALL	Select spooled files with all values. This criterion does not distinguish editions of the report.
character-value	Specify the spooled file user data that identifies editions of the report.

Element 4: Job name

*SAME	The value is not changed.
*ALL	Select spooled files with all values. This criterion does not distinguish editions of the report.
name	Specify the job name that identifies editions of the report.
generic-name	Specify a generic name. Spooled files whose job name begins with the specified characters are selected.

Element 5: Form type

*SAME	The value is not changed.
*ALL	Select spooled files with all values. This criterion does not distinguish editions of the report.
name	Specify the form type that distinguishes editions of the report.

Element 6: User

*SAME	The value is not changed.
*ALL	Select spooled files with all values. This criterion does not distinguish editions of the report.
name	Specify the user name that identifies editions of the report.
generic-name	Specify a generic name. Spooled files created by user names beginning with the specified characters are selected.

Element 7: Accounting code

*SAME	The value is not changed.
*ALL	Select spooled files with all values. This criterion does not distinguish editions of the report.
character-value	Specify the accounting code that identifies editions of the report.

Element 8: Print text

*SAME	The value is not changed.
*ALL	Select spooled files with all values. This criterion does not distinguish editions of the report.
print-text	Specify the print text that identifies editions of the report.

Element 9: Printer device type

Printer device type specifies the type of printer data stream contained in the spooled file.

*SAME	The value is not changed.
*ALL	Select spooled files with all values. This criterion does not distinguish editions of the report.
*AFPDS	Only spooled files containing an Advanced Function Printing Data Stream are selected by this report.
*AFPDSL	Only spooled files containing an AFPDS data mixed with 1403 line data are selected by this report.
*IPDS	Only spooled files containing an Intelligent Printer Data Stream are selected by this report.
*LINE	Only spooled files containing 1403 line data are selected by this report.
*SCS	Only spooled files containing an SNA Character Stream data stream are selected by this report.
*USERASCII	Only spooled files containing an ASCII data stream are selected by this report.

Element 10: Output queue

Output queue specifies the output queue that must contain the spooled file in order to be selected by this report.

Single values	*SAME	The value is not changed.
	*ALL	Select spooled files with all values. This criterion does not distinguish editions of the report.
Qualifier 1: Output queue	name	Specify the output queue that identifies editions of this report.
Qualifier 2: Library	*ALL	Select spooled files with all values. The library name does not distinguish editions of the report.
	name	Specify the qualifying library name that distinguishes editions of the report.

Element 11: Device file

Single values	*SAME	The value is not changed.
	*ALL	Select spooled files with all values. This criterion does not distinguish editions of the report.
Qualifier 1: Device file	name	Specify the device file that is used to create editions of the report.
Qualifier 2: Library	*ALL	Select spooled files with all values. The library name does not distinguish editions of the report.
	name	Specify the qualifying library name that distinguishes editions of the report.

Element 12: Front overlay

Single values	*SAME	The value is not changed.
	*ALL	Select spooled files with all values. This criterion does not distinguish editions of the report.
Qualifier 1: Front overlay	name	Specify the front overlay that is used to create editions of the report.
Qualifier 2: Library	*ALL	Select spooled files with all values. The library name does not distinguish editions of the report.
	name	Specify the qualifying library name that distinguishes editions of the report.

Element 13: Back overlay

Single values	*SAME	The value is not changed.
	*ALL	Select spooled files with all values. This criterion does not distinguish editions of the report.
Qualifier 1: Back overlay	name	Specify the back overlay that is used to create editions of the report.
Qualifier 2: Library	*ALL	Select spooled files with all values. The library name does not distinguish editions of the report.

name Specify the qualifying library name that distinguishes editions of the report.

Element 14: Form definition

Single values

*SAME	The value is not changed.
*ALL	Select spooled files with all values. This criterion does not distinguish editions of the report.

Qualifier 1: Form definition **name** Specify the form definition that is used to create editions of the report.

Qualifier 2: Library ***ALL** Select spooled files with all values. The library name does not distinguish editions of the report.

name Specify the qualifying library name that distinguishes editions of the report.

Element 15: Page definition

Single values

*SAME	The value is not changed.
*ALL	Select spooled files with all values. This criterion does not distinguish editions of the report.

Qualifier 1: Page definition **name** Specify the page definition that is used to create editions of the report.

Qualifier 2: Library ***ALL** Select spooled files with all values. The library name does not distinguish editions of the report.

name Specify the qualifying library name that distinguishes editions of the report.

Element 16: Minimum pages

***SAME** The value is not changed.

***NOMIN** Select spooled files with all values. A minimum number of pages to print does not distinguish editions of the report.

integer Only spooled files containing this number of pages or more are selected by this report.

Element 17: Maximum pages

***SAME** The value is not changed.

***NOMAX** Select spooled files with all values. A maximum number of pages to print does not distinguish editions of the report.

integer Only spooled files containing this number of pages or fewer are selected by this report.

Element 18: Spooled file number

***SAME** The value is not changed.

***ALL** Select spooled files with all values. This criterion does not distinguish editions of the report.

1-99999 Specify the spooled file number that identifies editions of the report.

Selection processing sequence (SELECTSEQ)

Specifies the sequence in which the report is processed.

***SAME** The value is not changed.

1-9999 Specify a selection sequence.

User process program (USRPRCPGM)

Specifies the name of the user process program.

A user process program is a user written program that is given control by a report writer to perform functions not supplied by Report Manager. User process programs can be specified for a report and as the destination of subscriptions. A user process program specified for a report is given control after the report has been identified, and before any subscription staging has been performed. User process programs specified on subscriptions are given control after all subscriptions have been staged and before other subscriptions are delivered.

Report writers pass 2 parameters to user process programs, a spooled file attribute record and a log entry buffer.

spooled-file-attribute-record The attribute record contains specific information about the spooled file to process. The format of the record is identical to format SPLA0200 returned by system interface program QUSRSPLA. For the layout of this record and a complete discussion of its content see the *Programming > Application programming interfaces > QUSRSPLA - Retrieve Spooled File Attributes* topic in the IBM i Information Center at <http://publib.boulder.ibm.com/series/>.

log-entry-buffer The log entry buffer contains data from the report distribution log. The data has one of two formats depending on whether a report or a subscription is being processed:

- When the user process program is called because it was named on **USRPRCPGM** parameter of a report it is passed a report log entry.
 - A report log entry is identified by a record ID of "E" in the first position of the log buffer.
 - The format of the entry is identical to that of record RMEVTR in file RMEVT. For the layout of this record use the Display File Field Description (DSPFFD) command.
- When the user process program is called because it was named in the **USRPRCPGM** parameter as a subscription's destination, it is passed a subscription log entry.
 - A subscription log entry is identified by a record ID of "D" in the first position of the log buffer.
 - The format of the entry is identical to that of record RMDSTR in file RMDST. For the layout of this record use the Display File Field Description (DSPFFD) command.

Any escape messages received by the report writer from the user process program are added to the report distribution log.

Note: Report Manager includes example programs with source code. Check the source file RMSOURCE and a current PTF list.

Single values

***SAME** The value is not changed.
***NONE** No program is called by a report writer.

Qualifier 1: User process program

name Specify the name of the program which is called by a report writer.

Qualifier 2: Library

***LIBL** All libraries in the thread's library list are searched.
***CURLIB** Use the current library for the job. If no library is specified as the current library for the job, QGPL is used.
name Specify the name of the library.

Abstract (ABSTRACT)

Specifies an abstract of the report.

An abstract gives a brief overview of the contents of a report. It may also be used to refer the reader to other documentation for a more detailed explanation of the report.

***SAME** The value is not changed.
character-value Specify an abstract of the report's content.

Library to receive archive (ARCLIB)

Specifies the library that receives the archives created by report writers for each spooled file processed.

Note: A "Library to receive archive" (ARCLIB) parameter is provided on both reports and report writers. When both are specified, the report takes precedence.

***SAME** The value is not changed.
***NONE** Report writers do not create an archive from each spooled file processed.
***WTR** Use the library specified on the Start Report Writer (STRRPTWTR) command.

name Specify the name of the library.

Examples

Example 1:

```
CHGRPT RPT (REPORTS/INV320) COPIES (*RPTSUB)
```

This command changes a report named INV320 in library REPORTS. The number of copies printed is changed to depend on the copies called for by subscriptions to the report. All other parameters of the report remain unchanged.

Example 2:

```
CHGRPT RPT (REPORTS/AP1099SUM) GROUP (ACCTG) DELIVERY (BIN5)  
CHGRPT RPT (REPORTS/AP1099DET) GROUP (ACCTG) DELIVERY (BIN5)
```

These commands change two reports named AP1099SUM and AP1099DET in library REPORTS. Both are identified as part of the ACCTG Report group with a default Delivery point of BIN5. All other parameters of these reports remain unchanged.

Error messages

Parameter dependencies

RDM7025	A printer device is required when output queue *DEV is specified.
RDM7026	When a printer device is specified output queue *DEV is required.
RDM7027	Subscriptions must be allowed when *RPTSUB is specified for copies.

Change Report Filter (CHGRPTFTR)

Where allowed to run: All environments (*ALL)

Threadsafe: No

The Change Report Filter (CHGRPTFTR) command changes a filter in a report.

A report filter specifies test criteria for a report that are used to reduce the number of pages delivered for a subscription. After a filter has been added to a report, it may be specified on one or more subscriptions. When a report writer processes the subscription, it tests each page of the spooled file against the filter criteria to determine if the page is selected for distribution. A page is selected when the data on the page meets the criteria specified.

All selected pages are placed in a new spooled file. If the user data (USRDTA) attribute of the original spooled file is blank, the new spooled file has the filter's name for user data.

Parameters

Keyword	Description	Choices	Notes
RPT	Report	<i>Qualified object name</i>	Required, Key, Positional 1
	Qualifier 1: Report	<i>Generic name, name, *ALL</i>	
	Qualifier 2: Library	<i>Name, *LIBL, *CURLIB, *USRLIBL, *ALLUSR, *ALL</i>	
RPTFTR	Report filter	<i>Name</i>	Required, Key, Positional 2
PAGCMPDTA	Page compare data	<i>Element list</i>	Optional, Positional 3
	Element 1: Line	1-255, *SAME , *ALL	
	Element 2: Position	1-378, *SAME , *ALL	
	Element 3: Compare value	<i>Character value, *SAME</i>	
PAGCMPDTAA	Element 4: Compare test	*EQ , *NE, *SAME	Optional
	Page compare data, more	Single values: *SAME , *NONE Other values (up to 15 repetitions): <i>Element list</i>	
	Element 1: Conjunction	*AND , *OR	
	Element 2: Line	1-255, *ALL	
	Element 3: Position	1-378, *ALL	
	Element 4: Compare value	<i>Character value</i>	
Element 5: Compare test	*EQ , *NE		

Report (RPT)

Specifies the name of the report and the library where it resides.

This is a required parameter.

Qualifier 1: Report

- name** Specify the name of the report.
- generic-name** Specify a generic name. Reports whose names begin with the specified characters are selected.
- *ALL** All reports in the library or libraries are selected.

Qualifier 2: Library

- *LIBL** All libraries in the thread's library list are searched.
- *CURLIB** Use the current library for the job. If no library is specified as the current library for the job, QGPL is used.
- *USRLIBL** Only the libraries in the user portion of the thread's library list are searched.
- *ALL** All libraries in the system including QSYS are searched.
- *ALLUSR** All non-system libraries on the machine are searched.
- name** Specify the name of the library.

Report filter (RPTFTR)

Specifies the name of the report filter. Filter names are unique within a report.

This is a required parameter.

name Specify the name of the filter.

Page compare data (PAGCMPDTA)

Specifies the comparison that determines which pages of a spooled file are selected for output. The comparison consists of a character string value and the line and position at which it is located.

Element 1: Line

***SAME** The value is not changed.
1-255 Specify the line number where the comparison starts on the page.
***ALL** All lines on the page are compared. If the compare value is found on at least one line, the page is selected.

Element 2: Position

***SAME** The value is not changed.
1-378 Specify the position where the comparison starts in the line. Valid values range from 1 through 378. The value specified plus the length of the compare value should be less than the number of print positions in the spooled file.
***ALL** All positions in the line are compared. If the compare value is found in at least one position, the page is selected.

Element 3: Compare value

***SAME** The value is not changed.
character-value Specify the value (up to 16 characters long) to be compared with the specified line/position on the page. Only the number of characters entered are compared to the page. The value must be specified in apostrophes if it contains leading or trailing blanks. The comparison is case sensitive.

Note: Leading and trailing blanks are not allowed when *ALL is specified for character position.

Element 4: Compare test

***SAME** The value is not changed.
***EQ** If the compare data is located on the page, the page is selected.
***NE** If the compare data is not located on the page, the page is selected.

Page compare data, more (PAGCMPDTAA)

Specifies additional comparisons the page must meet to be selected for output, and the relationship between the comparisons. Up to 15 additional comparisons can be specified.

Use the *AND and *OR conjunctions, as needed, between pairs of comparisons to indicate how the comparisons are to be related and grouped. An *AND indicates that the pair must both be true before the results of the *AND can be true. An *OR value indicates that only one of the comparisons need to be true for the *OR to be true.

If all *ANDs are specified, only pages that meet all of the comparisons are selected. If you want to select all pages that meet at least one of the tests, specify *ORs to connect each one of the comparisons.

When you use both *ANDs and *ORs, each *OR separates groups of comparisons connected by *ANDs. Starting from the first comparison, if the results of all the *ANDs in a group are all true, the page is selected. If the comparisons are not all true, the next group of *ANDs are considered.

Single values

***SAME** The additional comparisons do not change.
***NONE** There are no additional comparisons.

Element 1: Conjunction

***AND** An additional *AND comparison is performed.
***OR** An additional *OR comparison is performed.

Element 2: Line

- 1-255** Specify the line number where the comparison starts on the page.
***ALL** All lines on the page are compared. If the compare value is found on at least one line, the page is selected.

Element 3: Position

- 1-378** Specify the position where the comparison starts in the line. Valid values range from 1 through 378. The value specified plus the length of the compare value should be less than the number of print positions in the spooled file.
***ALL** All positions in the line are compared. If the compare value is found in at least one position, the page is selected.

Element 4: Compare value

- character-value** Specify the value (up to 16 characters long) to be compared with the specified line/position on the page. Only the number of characters entered are compared to the page. The value must be specified in apostrophes if it contains leading or trailing blanks. The comparison is case sensitive.

Note: Leading and trailing blanks are not allowed when *ALL is specified for character position.

Element 5: Compare test

- *EQ** If the compare data is located on the page, the page is selected.
***NE** If the compare data is not located on the page, the page is selected.

Examples

Example 1:

```
CHGRPTFTR RPTFTR (WESTERNREG) RPT (SOE112)
          PAGCMPDTA (3 *SAME *SAME)
```

This command changes the filter named WESTERNREG in the SOE112 report. After the change, the filter compares data on line 3 of each spooled file page. The position and compare value remain the same.

Example 2:

```
CHGRPTFTR RPTFTR (TOTALSONLY) RPT (INV310)
          PAGCMPDTA (*SAME *SAME TOTALS)
```

This command changes the filter named TOTALSONLY in the INV310 report. After the change, the filter checks for the value 'TOTALS'. The line and position at which the comparison occurs remains the same.

Change Report Subscription (CHGRPTSUB)

Where allowed to run: All environments (*ALL)

Threadsafe: No

The Change Report Subscription (CHGRPTSUB) command changes a subscription to a report.

Parameters

Keyword	Description	Choices	Notes
RPT	Report	<i>Qualified object name</i>	Required, Key, Positional 1
	Qualifier 1: Report	<i>Generic name, name, *ALL</i>	
	Qualifier 2: Library	<i>Name, *LIBL, *CURLIB, *USRLIBL, *ALLUSR, *ALL</i>	
USER	User	<i>Name, *CURRENT, *CREATOR, *USRID, *CREATOR2</i>	Optional, Key, Positional 2
USRID	Network user	Single values: <i>*NONE, *SPLFCRT, *SPLFOWN</i> Other values: <i>Element list</i>	Optional, Key, Positional 3
	Element 1: User ID	<i>Character value</i>	
	Element 2: Address	<i>Character value</i>	
SUBNBR	Subscription number	1-255, <u>1</u>	Optional, Key, Positional 4
OUTQ	Destination output queue	Single values: <i>*SAME, *RPT, *WTR, *DEV, *USRPRF, *JOB, *NONE</i> Other values: <i>Qualified object name</i>	Optional, Positional 5
	Qualifier 1: Destination output queue	<i>Name</i>	
	Qualifier 2: Library	<i>Name, *LIBL, *CURLIB</i>	
PRTDEV	Printer device	<i>Name, *SAME, *SYSVAL, *USRPRF, *NONE</i>	Optional, Positional 6
USRPRCPGM	User process program	Single values: <i>*SAME, *NONE</i> Other values: <i>Qualified object name</i>	Optional, Positional 7
	Qualifier 1: User process program	<i>Name</i>	
	Qualifier 2: Library	<i>Name, *LIBL, *CURLIB</i>	
DELIVERY	Delivery point	<i>Character value, *SAME, *RPT, *NONE</i>	Optional, Positional 8
FRMTYP	Form type	<i>Character value, *SAME, *RPT, *SPLF</i>	Optional, Positional 9
COPIES	Copies	1-255, <i>*SAME, *SPLF</i>	Optional, Positional 10
STRDATE	Start date	<i>Date, *SAME, *IMMED</i>	Optional, Positional 11
ENDDATE	End date	<i>Date, *SAME, *PERM</i>	Optional, Positional 12
RPTFTR	Report filter	<i>Name, *SAME, *NONE, *UNSELECT</i>	Optional, Positional 13
OMITZERO	Omit zero page delivery	<i>*SAME, *RPT, *YES, *NO</i>	Optional, Positional 14
DLVSTS	Deliver status	<i>*SAME, *RPT, *READY, *HELD</i>	Optional, Positional 15
SNDFMT	Send format	<i>*SAME, *RPT, *ALLDATA, *RCDDATA, *EMAIL</i>	Optional, Positional 16
TRANSFORM	Transform to perform	<i>Character value, *SAME, *RPT, *TXT, *PDFLETTER, *PDFLEGAL, *PDFA4, *RTFLETTER, *RTFLEGAL, *RTFA4</i>	Optional, Positional 17
TOOBJ	Object (PC file)	<i>Character value, *SAME, *NONE, *ACGCDE, *BIN, *BIN8, *CRTSYS, *CRTUSR, *FILE, *FILE8, *FTR, *FTR8, *GRP, *GRP8, *JOBNAM, *JOBNAM8, *JOBNBR, *JOBUSR, *JOBUSR8, *OUTQ, *PAGECOUNT, *PAGECNTZ, *PGM, *PGM8, *PRTTXT, *RPT, *RPT8, *SPLCDAT, *SPLCTIM, *SPLCCYY, *SPLCYY, *SPLCMM, *SPLCDD, *SPLNBR, *SPLNBRZ, *SUB, *SUB8, *SUBNBR, *USRDTA, *USRDFNDTA</i>	Optional, Positional 18

Report (RPT)

Specifies the name of the report and the library where it resides.

This is a required parameter.

Qualifier 1: Report

<i>name</i>	Specify the name of the report.
<i>generic-name</i>	Specify a generic name. Reports whose names begin with the specified characters are selected.
*ALL	All reports in the library or libraries are selected.

Qualifier 2: Library

*LIBL	All libraries in the thread's library list are searched.
*CURLIB	Use the current library for the job. If no library is specified as the current library for the job, QGPL is used.
*USRLIBL	Only the libraries in the user portion of the thread's library list are searched.
*ALL	All libraries in the system including QSYS are searched.
*ALLUSR	All non-system libraries on the machine are searched.
<i>name</i>	Specify the name of the library.

User (USER)

Specifies the user who is subscribed to the report.

*CURRENT	The subscription is for the user of the current job.
*CREATOR	The subscription is for the user creating the spooled file. Report writers resolve this value using the user portion of the qualified job name that contains the spooled file.
*CREATOR2	The subscription is for the user creating the spooled file. Report writers resolve this value using information in the spooled file's attributes. Use this value if the spooled file was originally created on another system.
*USRID	The subscription is for the network user identified by the USRID parameter.
<i>name</i>	Specify the name of the user profile.

Network user (USRID)

Specifies the network user who is subscribed to the report. A network user receives subscriptions on the local system or on a remote system as email or through the SNADS network. For email, subscriptions are delivered as a message with the spooled file placed in an attached file. For SNADS networks, subscriptions are placed on the output queue specified in the user profile of the network user. Network users are identified by a two part user ID or by a two part distribution list ID.

A network user receives subscriptions on the local system or on a remote system as email or through the SNADS network. For email, subscriptions are delivered as a message with the spooled file placed in an attached file. For SNADS networks, subscriptions are placed on the output queue specified in the user profile of the network user. Network users are identified by a two part user ID or by a two part distribution list ID.

Single values

*NONE	The subscription is not for a network user.
*SPLFCRT	The subscription is for the user creating the spooled file. Report writers resolve this value using information in the spooled file's attributes. Use this value if the spooled file was originally created on another system. The directory entry for the user profile is retrieved to determine the target User ID and Address.
*SPLFOWN	The subscription is for the user owning the spooled file. Report writers resolve this value using the user portion of the qualified job name that contains the spooled file. The directory entry for the user profile is retrieved to determine the target User ID and Address.

Element 1: User ID

character-value Specify the user ID (DEN) of the network user. CHAR(8)

Element 2: Address

character-value Specify the address (DGN) of the network user. CHAR(8)

Subscription number (SUBNBR)

Specifies the subscription number. Subscription numbers uniquely identify the subscriptions of an individual subscriber to a report. This allows a user or network user to subscribe to a report more than once.

Subscription numbers uniquely identify the subscriptions of an individual subscriber to a report. Subscription numbers allow a subscriber to subscribe to a report more than once.

<u>1</u>	Specifies subscription 1 for the subscriber.
1-255	Specify a subscription number.

Destination output queue (OUTQ)

Specifies the name of an output queue to which spooled files are delivered by a report writer. This parameter follows the rules of the OUTQ parameter of printer device files, job descriptions, user profiles and display devices outlined in *iSeries Printer Device Programming SC41-5713*.

Single values

*SAME	The value is not changed.
*RPT	The output queue specified by the report is used.
*WTR	The destination is determined at the time a report writer is delivering spooled files. If the report writer is started with a printer device specified on the DEV parameter then the spooled file is printed. If DEV(*NONE) is specified when the report writer is started then the default destination queue (DFTOUTQ) parameter is used as the destination.
*DEV	The output queue associated with the printer device is used.
*USRPRF	The output queue specified in the user profile of the report subscriber is used.
*JOB	The output queue of the job that created the spooled file is used.
*NONE	Spooled files are not delivered to an output queue.

Qualifier 1: Output queue

<i>name</i>	Specify the name of the output queue.
-------------	---------------------------------------

Qualifier 2: Library

*LIBL	All libraries in the thread's library list are searched.
*CURLIB	Use the current library for the job. If no library is specified as the current library for the job, QGPL is used.
<i>name</i>	Specify the name of the library.

Printer device (PRTDEV)

Specifies the name of a printer device description to which spooled files are delivered by a report writer. This parameter follows the rules of the DEV parameter of printer device files, job descriptions, user profiles and display devices outlined in *iSeries Printer Device Programming SC41-5713*.

*SAME	The value is not changed.
*NONE	Spooled files are not delivered to a printer device.
*SYSVAL	The printer device named in the QPRTDEV system value is used.
*USRPRF	The printer device specified in the user profile of the report subscriber is used.
<i>name</i>	Specify the name of the printer device to use.

User process program (USRPRCPGM)

Specifies the name of the user process program.

A user process program is a user written program that is given control by a report writer to perform functions not supplied by Report Manager. User process programs can be specified for a report and as the destination of subscriptions. A user process program specified for a report is given control after the report has been identified, and before any subscription staging has been performed. User process programs specified on subscriptions are given control after all subscriptions have been staged and before other subscriptions are delivered.

Report writers pass 2 parameters to user process programs, a spooled file attribute record and a log entry buffer.

spooled-file-attribute-record The attribute record contains specific information about the spooled file to process. The format of the record is identical to format SPLA0200 returned by system interface program QUSRSPLA. For the layout of this record and a complete discussion of its content see the *Programming > Application programming interfaces > QUSRSPLA - Retrieve Spooled File Attributes* topic in the IBM i Information Center at <http://publib.boulder.ibm.com/series/>.

log-entry-buffer The log entry buffer contains data from the report distribution log. The data has one of two formats depending on whether a report or a subscription is being processed:

- When the user process program is called because it was named on **USRPRCPGM** parameter of a report it is passed a report log entry.
 - A report log entry is identified by a record ID of "E" in the first position of the log buffer.
 - The format of the entry is identical to that of record RMEVTR in file RMEVT. For the layout of this record use the Display File Field Description (DSPFFD) command.
- When the user process program is called because it was named in the **USRPRCPGM** parameter as a subscription's destination, it is passed a subscription log entry.
 - A subscription log entry is identified by a record ID of "D" in the first position of the log buffer.
 - The format of the entry is identical to that of record RMDSTR in file RMDST. For the layout of this record use the Display File Field Description (DSPFFD) command.

Any escape messages received by the report writer from the user process program are added to the report distribution log.

Note: Report Manager includes example programs with source code. Check the source file RMSOURCE and a current PTF list.

Single values

***SAME** The value is not changed.
***NONE** No program is called by a report writer.

Qualifier 1: User process program

name Specify the name of the program which is called by a report writer.

Qualifier 2: Library

***LIBL** All libraries in the thread's library list are searched.
***CURLIB** Use the current library for the job. If no library is specified as the current library for the job, QGPL is used.
name Specify the name of the library.

Delivery point (DELIVERY)

Specifies the Delivery point for the subscription.

A delivery point is a named external destination. Delivery points refine and further subdivide the destination of a report or a subscription beyond what is possible by designating output queue alone. Delivery points can have any name and any meaning desired. For an installation with a large central print facility, delivery points might be the names of bins the print operator places the printed output into. At another installation, delivery points might be the office, room, floor or building numbers to which the printed output is delivered. A delivery point can be specified on reports and on subscriptions with subscriptions having precedence.

***SAME** The value is not changed.
***RPT** The delivery point is specified by the report.
***NONE** No delivery point is specified.
name Specify the name of the delivery point.

Form type (FRMTYP)

Specifies the form type on which to print the subscription.

*SAME	The value is not changed.
*RPT	Print on the form type specified by the report.
*SPLF	Print on the form type specified by the report's spooled file.
name	Specify the name of the form type.

Copies (COPIES)

Specifies the number of copies of the form type to print or send.

If the subscription is for a network user this is the number of copies sent on the SNDNETSPLF command.

*SAME	The value is not changed.
*SPLF	The number of copies specified by the report's spooled file are printed. These copies are in addition to copies specified on the report's subscriptions if any.
1-255	Specify the number of identical copies to print.

Start date (STRDATE)

Specifies the start date for the subscription.

A report subscription start date is the first date on which the subscription is eligible for processing by a report writer. When a report writer processes a report, it compares the date to the subscription start date to determine if actions specified by the subscriptions are taken.

*SAME	The value is not changed.
*IMMED	The subscription takes effect immediately regardless of the date.
date	Specify the date on which the subscription takes effect. The date must be specified in job-date format.

End date (ENDDATE)

Specifies the end date for the subscription.

A report subscription end date is the last date on which the subscription is eligible for processing by a report writer. When a report writer processes a report, it compares the date to the subscription end date to determine if actions specified by the subscriptions are taken.

*SAME	The value is not changed.
*PERM	The subscription is in effect permanently.
date	Specify the last date on which the subscription is in effect. The date must be specified in job-date format.

Report filter (RPTFTR)

Specifies the name of the report filter. Filter names are unique within a report.

A report filter specifies test criteria for a report that are used to reduce the number of pages delivered for a subscription. After a filter has been added to a report, it may be specified on one or more subscriptions. When a report writer processes the subscription, it tests each page of the spooled file against the filter criteria to determine if the page is selected for distribution. A page is selected when the data on the page meets the criteria specified.

All selected pages are placed in a new spooled file. If the user data (USRDTA) attribute of the original spooled file is blank, the new spooled file has the filter's name for user data.

*SAME	The value is not changed.
*NONE	Specifies that no filter is used to select pages. The entire spooled file is distributed.
*UNSELECT	Specifies that the special unselect filter selects pages. This filter selects all pages from a spooled file that were not selected by any of the other filters processed by the report writer.
name	Specify the name of the filter.

Omit zero page delivery (OMITZERO)

Specifies how delivery should be handled when a page filter selects zero pages from a spooled file (when no pages match a filter's criteria).

*SAME	The value is not changed.
*RPT	The delivery action specified by the report determines how zero pages are delivered.
*YES	Omit the delivery when a filter selects zero pages from a spooled file.
*NO	Do not omit the delivery even though zero pages are selected from the spooled file.

Deliver status (DLVSTS)

Specifies the status a spooled file has when it is delivered.

*SAME	The value is not changed.
*RPT	The delivery status specified by the report determines how spooled files are delivered.
*READY	Spooled files are delivered with a status of ready.
*HELD	Spooled files are delivered with a status of held.

Send format (SNDFMT)

Specifies the format in which the spooled file is sent to a network user.

*SAME	The value is not changed.
*RPT	The send format specified by the report determines how spooled files are sent to network subscribers.
*ALLDATA	Spooled files are delivered using the Send Net Spooled File (SNDNETSPLF) command with DTAFMT(*ALLDATA).
*RCDDATA	Spooled files are delivered using the Send Net Spooled File (SNDNETSPLF) command with DTAFMT(*RCDDATA).
*EMAIL	Spooled files are delivered as Email.

Transform to perform (TRANSFORM)

Specifies the manner in which the spooled file is transformed when Report Manager is integrated with SpoolMail or Spool-a-Matic. If these products are not installed the value is ignored.

*SAME	The value is not changed.
*RPT	The transform specified by the report determines how spooled files are transformed.
*TXT	Spooled files are transformed using the built in Report Manager support.
transform	Specify any of the SpoolMail or Spool-a-Matic transforms.

Object (PC file) (TOOBJ)

Specifies the path name of the object (PC file) to create.

For more information on specifying path names, see *Programming > Control language > CL concepts > IBM i objects > Object naming rules* topic in the IBM i Information Center at <http://publib.boulder.ibm.com/series/>.
CHAR(5000)

*SAME	The value is not changed.
*NONE	No object (PC file) is created.
path-name	Specify up to 64 characters of path name. For example to create a file with name abc.txt in a directory with name mydirectory , specify '/mydirectory/abc.txt'

Report Manager provides several special values that can be used to construct dynamic object (PC file) names. When the special values are found, the associated data is blank trimmed and substituted into the path specified when it is processed. If the data associated with a special value is blank, "BLANK" is substituted. If the data associated with a special value contains characters not allowed in an object name, question marks (?) for example, the name will be

invalid and the command will fail. The special values must be delimited by an underscore ('_') a period ('.') a slash ('/' or '\') or another special value (which starts with '*').

The Report Manager related special values are:

*BIN	Delivery point from the subscription CHAR(10).
*BIN8	Same as *BIN truncated to CHAR(8).
*FTR	Filter name from the subscription CHAR(10).
*FTR8	Same as *FTR truncated to CHAR(8).
*GRP	Report group from the report CHAR(10).
*GRP8	Same as *GRP truncated to CHAR(8).
*RPT	Report name CHAR(10).
*RPT8	Same as *RPT truncated to CHAR(8).
*SUB	Subscriber name CHAR(10).
*SUB8	Same as *SUB truncated to CHAR(8).
*SUBNBR	Subscription number converted to text. Length varies.

The spooled file attribute related special values are:

*ACGCDE	Accounting code CHAR(15).
*CRTSYS	System created on originally CHAR(8). This can differ from the current system's name if the spooled file was sent from another System i.
*CRTUSR	User creating originally CHAR(10). This can differ from the *JOBUSR value if the spooled file was sent from another System i.
*FILE	Spooled file name CHAR(10).
*FILE8	Same as *FILE truncated to CHAR(8).
*FORMTYPE	Spooled file form type CHAR(10). Make sure special values in the data are compatible with usage. For example few file systems allow * in a name. If the form type is *STD, the name will be invalid.
*JOBNAM	Name portion of the job containing the spooled file CHAR(10).
*JOBNAM8	Same as *JOBNAM truncated to CHAR(8).
*JOBNBR	Job number of the job containing the spooled file CHAR(6).
*JOBUSR	User portion of the job containing the spooled file CHAR(10).
*JOBUSR8	Same as *JOBUSR truncated to CHAR(8).
*OUTQ	Output queue the file is on CHAR(10).
*PAGECOUNT	Spooled file page count converted to text. CHAR(6) or more.
*PAGECNTZ	Spooled file page count converted to text with leading zeros removed. Length varies.
*PGM	Program that opened the file CHAR(10).
*PGM8	Same as *PGM truncated to CHAR(8).
*PRTTXT	Print text CHAR(30).
*SPLCDAT	Date the spooled file was open CHAR(7) CYYMMDD.
*SPLCTIM	Time the spooled file was opened CHAR(6) HHMMSS.
*SPLCCYY	Century-year portion of the date the spooled file was open CHAR(3) CYY.
*SPLCYY	Year portion of the date the spooled file was open CHAR(2) YY.
*SPLCMM	Month portion of the date the spooled file was open CHAR(2) MM.
*SPLCDD	Day portion of the date the spooled file was open CHAR(2) DD.
*SPLNBR	Spooled file number converted to text. CHAR(6).
*SPLNBRZ	Spooled file number converted to text with leading zeros removed. Length varies.
*USRDFNDA	User defined data CHAR(255).
*USRDFNTXT	User-defined text taken from the user profile when the spooled file was created. Add text to a user profile using the CHGUSRPRTI command CHAR(100).
*USRDTA	User data CHAR(10).

Examples

Example 1:

```
CHGRPTSUB RPT (REPORTS/INV310) DELIVERY (BIN28)
```

This command changes subscription number 1 to report INV310 for the user issuing the command. The report containing the subscription is located in library REPORTS. The subscription's Delivery point is changed to BIN28. All other attributes of the subscription remain unchanged.

Example 2:

```
CHGRPTSUB RPT (PURCH9) USER (QPGMR) SUBNBR (2) OUTQ (PGMROFC)
```

This command changes QPGMR's second subscription to report PURCH9. The PURCH9 report is located using the thread's library list. The subscription is delivered to output queue PGMROFC after the change.

Example 3:

```
CHGRPTSUB RPT (MKRPT2) USER (*USRID) USRID (BSMITH SEATTLE)
          FRMTYP (CUT811) COPIES (2)
```

This command changes subscription number 1 to report MKRPT2 for network user BSMITH at SEATTLE. The subscription is changed to deliver 2 copies on form type CUT811.

Error messages

Parameter dependencies

RDM7006	When user *USRID is specified a network user must be specified.
RDM7012	A network user or a user can be specified, but not both.
RDM7007	When network user *NONE is specified user *USRID cannot be specified.
RDM7008	A subscription must have one and only one destination.
RDM7009	When the output queue is *DEV a printer device must be specified.
RDM7010	When a printer device is specified output queue *NONE or *DEV is required.
RDM7011	Start date must be before end date.

Change Report Writer (CHGRPTWTR)

Where allowed to run: All environments (*ALL)

Threadsafe: No

The Change Report Writer (CHGRPTWTR) command changes a report writer's print options, number of file separators and separator drawer.

Parameters

Keyword	Description	Choices	Notes
WTR	Writer	<i>Generic name, name, *ALL</i>	Required, Positional 1
PRTOPT	Print options	<i>Element list</i>	Optional, Positional 2
	Element 1: Form type	<i>Character value, *SAME, *ALL, *FORMS</i>	
	Element 2: Report group	<i>Name, *SAME, *ALL, *GROUPS</i>	
	Element 3: Delivery point	<i>Character value, *SAME, *ALL, *POINTS</i>	
	Element 4: User	<i>Name, *SAME, *ALL, *USERS</i>	
	Element 5: Message option	<i>*SAME, *INQMSG, *MSG, *NOMSG, *INFOMSG</i>	
FILESEP	File separators	0-9, <i>*SAME, *FILE, *COPIES</i>	Optional, Positional 3
SEPDRAWER	Drawer for separators	1-3, <i>*SAME, *FILE</i>	Optional, Positional 4
OPTION	When to change report writer	<i>*NORDYE, *FILEEND</i>	Optional, Positional 5

Writer (WTR)

Specifies the name of the report writer.

This is a required parameter.

<i>name</i>	Specify the name of the report writer.
<i>generic-name</i>	Specify a generic name. Report writers whose names begin with the specified characters are selected.
<i>*ALL</i>	All report writers are selected.

Print options (PRTOPT)

Specifies the report writer print options.

Print options determine which spooled files are printed and the order in which they are printed by a report writer. Only the spooled files specified are printed. All other files remain on the output queue as available. To change the options after a report writer is started, use the Change Report Writer (CHGRPTWTR) command.

Print options are made up of 5 elements.

Element 1: Form type

Spooled files are printed by form type.

<i>*SAME</i>	The value is not changed.
<i>*ALL</i>	All available files on the output queue are printed regardless of their form types.
<i>*FORMS</i>	All available spooled files on the output queue with the same form type are printed before the writer moves to the next form type. The report writer first chooses the first available spooled file on the queue. After the first spooled file is complete, all other spooled files with the same form type are printed. The report writer again chooses the first available spooled file on the queue and repeats the process for that form type.
<i>name</i>	Specify the type of form to print.

Element 2: Report group

Spooled files are printed by report group.

<i>*SAME</i>	The value is not changed.
---------------------	---------------------------

- *ALL** All available files on the output queue are printed regardless of their report groups.
 - *GROUPS** All available spooled files on the output queue from the same report group are printed before the writer moves to the next report group. The report writer first chooses the first available spooled file on the queue. After the first spooled file is complete, all other spooled files from the same report group are printed. The report writer again chooses the first available spooled file on the queue and repeats the process for that report group.
- name*** Specify the name of the report group to print.

Element 3: Delivery point

Spooled files are printed by delivery point.

- *SAME** The value is not changed.
 - *ALL** All available files on the output queue are printed regardless of their delivery points.
 - *POINTS** All available spooled files on the output queue for the same delivery point are printed before the writer moves to the next delivery point. The report writer first chooses the first available spooled file on the queue. After the first spooled file is complete, all other spooled files for the same delivery point are printed. The report writer again chooses the first available spooled file on the queue and repeats the process for that delivery point.
- name*** Specify the name of the delivery point to print.

Element 4: User

Spooled files are printed by user (recipient).

- *SAME** The value is not changed.
 - *ALL** All available files on the output queue are printed regardless of their users (recipients).
 - *USERS** All available spooled files on the output queue for the same user (recipient) are printed before the writer moves to the next user (recipient). The report writer first chooses the first available spooled file on the queue. After the first spooled file is complete, all other spooled files for the same user (recipient) are printed. The report writer again chooses the first available spooled file on the queue and repeats the process for that user (recipient).
- name*** Specify the name of the user (recipient) whose spooled file are printed.

Element 5: Message option

Specifies the type of messages is sent.

- *SAME** The value is not changed.
- *INQMSG** The report writer sends an inquiry to the message queue when a spooled file has form type that is different than the form type in the printer.
- *MSG** The report writer sends an inquiry to the message queue when a spooled file has form type that is different than the form type in the printer and an informational message is sent when there are no spooled files for the specified print option.
- *NOMSG** The report writer does not send inquiry or informational messages.
- *INFOMSG** The report writer sends a message when there are no spooled files for the specified print option. As additional spooled files become available for printing, they are printed in accordance with the print options specified. The message is sent again each time the writer must wait for additional spooled files.

File separators (FILESEP)

Specifies the number of separator pages that are printed between each file.

- *SAME** The value is not changed.
 - *FILE** The number of separator pages specified by each spooled file is used.
 - *COPIES** The number of separator pages is the same as the number of spooled file copies.
- 0-9** Specify a number of separator pages to print.

Drawer for separators (SEPDRAWER)

Specifies which paper drawer is selected for printing separators.

- *SAME** The value is not changed.
 - *FILE** The separator pages are printed from the same drawer as the spooled file.
- 1-3** Specify a number from 1 to 3 of the drawer from which separators are printed.

When to change report writer (OPTION)

Specifies when the changes occur.

*NORDYF	The change occurs when there are no files on the output queue that meet the report writer's current print option values.
*FILEEND	The change occurs at the end of the current file.

Examples

Example 1:

```
CHGRPTWTR WTR(PRT01) PRTOPT(*ALL *ALL *ALL BILLK)
```

This command changes report writer PRT01. The changes take effect when there are no more files that satisfy the report writer's current print options. After the change takes effect, the report writer will print all reports on the output queue intended for subscriber BILLK.

Example 2:

```
CHGRPTWTR WTR(PRT01) PRTOPT(*ALL *ALL *ALL *USERS *MSG)
```

This command changes report writer PRT01. The changes take effect when there are no more files that satisfy the report writer's current print options. After the change takes effect, the report writer will determine the first subscriber who has a delivery on the output queue. The report writer will print all the reports for this subscriber and then repeat the process. A message is sent each time the report writer runs out of reports for an individual subscriber.

Example 3:

```
CHGRPTWTR WTR(PRT01) PRTOPT(*ALL *ALL BIN6 *ALL *MSG)
```

This command changes report writer PRT01. The changes take effect when there are no more files that satisfy the report writer's current print options. After the change takes effect, the report writer will print all reports on the output queue that specify BIN6 as the delivery point. A message is sent when this has been accomplished.

Check Report Manager Authorization (CHKRM1AUT)

Where allowed to run: All environments (*ALL)

Threadsafe: No

The Check Report Manager Authorization (CHKRM1AUT) command executes Report Manager's authorization verification function. This allows you to determine whether and how the product is authorized for use.

Parameters

Keyword	Description	Choices	Notes
MSGQ	Message queue	Single values: <u>*NONE</u> Other values: <i>Qualified object name</i>	Optional, Positional 1
	Qualifier 1: Message queue	<i>Name</i>	
	Qualifier 2: Library	<i>Name</i> , <u>*LIBL</u> , *CURLIB	

Message queue (MSGQ)

Specifies a message queue that should receive messages if the product is not permanently authorized.

Single values

*NONE Messages are not sent to an external message queue.

Qualifier 1: Message queue

name Specify the name message queue that receives messages.

Qualifier 2: Library

*LIBL All libraries in the thread's library list are searched.

*CURLIB Use the current library for the job. If no library is specified as the current library for the job, QGPL is used.

name Specify the name of the library.

Examples

Example 1:

```
CHKRM1AUT
```

This command executes Report Manager's authorization verification function to determine whether and how the product is authorized for use.

Example 2:

```
CHKRM1AUT MSGQ(QSYSOPR)
```

This command executes Report Manager's authorization verification function to determine whether and how the product is authorized for use. If the product is not permanently authorized for use, a failure message is sent to the system operator's message queue.

Copy Report (CPYRPT)

Where allowed to run: All environments (*ALL)

Threadsafe: No

The Copy Report (CPYRPT) command copies an existing report.

Parameters

Keyword	Description	Choices	Notes
FROMRPT	From report	<i>Qualified object name</i>	Required, Positional 1
	Qualifier 1: From report	<i>Name</i>	
	Qualifier 2: Library	<i>Name, *LIBL, *CURLIB</i>	
TORPT	To report	<i>Qualified object name</i>	Required, Positional 2
	Qualifier 1: To report	<i>Name</i>	
	Qualifier 2: Library	<i>Name, *CURLIB</i>	

From report (FROMRPT)

Specifies the report that is the source for the copy.

This is a required parameter.

Qualifier 1: Report

name Specify the name of the report.

Qualifier 2: Library

***LIBL** All libraries in the thread's library list are searched.

***CURLIB** Use the current library for the job. If no library is specified as the current library for the job, QGPL is used.

name Specify the name of the library.

To report (TORPT)

Specifies the report that is the destination for the copy.

This is a required parameter.

Qualifier 1: Report

name Specify the name of the report.

Qualifier 2: Library

***CURLIB** Use the current library for the job. If no library is specified as the current library for the job, QGPL is used.

name Specify the name of the library.

Examples

Example 1:

```
CPYRPT FROMRPT (REPORTS/INV320) TORPT (REPORTS/INV330)
```

This command creates a report named INV330 in library REPORTS. The report is an exact copy of INV330 in library REPORTS.

Example 2:

```
CPYRPT FROMRPT (REPORTS/INV320) TORPT (REPORTTEST/INV320)
```

This command creates a report named INV320 in library REPORTTEST. The report is an exact copy of INV330 in library REPORTS.

Copy Report Filter (CPYRPTFTR)

Where allowed to run: All environments (*ALL)

Threadsafe: No

The Copy Report Filter (CPYRPTFTR) command copies filters from one report to another.

Parameters

Keyword	Description	Choices	Notes
FROMRPT	From report	<i>Qualified object name</i>	Required, Positional 1
	Qualifier 1: From report	<i>Name</i>	
	Qualifier 2: Library	<i>Name, *LIBL, *CURLIB</i>	
TORPT	To report	<i>Qualified object name</i>	Required, Positional 2
	Qualifier 1: To report	<i>Generic name, name, *ALL</i>	
	Qualifier 2: Library	<i>Name, *LIBL, *CURLIB, *USRLIBL, *ALLUSR, *ALL</i>	
RPTFTR	Report filter	<i>Generic name, name, *ALL</i>	Optional, Positional 3

From report (FROMRPT)

Specifies the report that is the source for the copy.

This is a required parameter.

Qualifier 1: Report

name Specify the name of the report.

Qualifier 2: Library

***LIBL** All libraries in the thread's library list are searched.

***CURLIB** Use the current library for the job. If no library is specified as the current library for the job, QGPL is used.

name Specify the name of the library.

To report (TORPT)

Specifies the report that is the destination for the copy.

This is a required parameter.

Qualifier 1: Report

name Specify the name of the report.

generic-name Specify a generic name. Reports whose names begin with the specified characters are selected.

***ALL** All reports in the library or libraries are selected.

Qualifier 2: Library

***LIBL** All libraries in the thread's library list are searched.

***CURLIB** Use the current library for the job. If no library is specified as the current library for the job, QGPL is used.

***USRLIBL** Only the libraries in the user portion of the thread's library list are searched.

***ALL** All libraries in the system including QSYS are searched.

***ALLUSR** All non-system libraries on the machine are searched.

name Specify the name of the library.

Report filter (RPTFTR)

Specifies the name of the report filter. Filter names are unique within a report.

***ALL** All filters in the report are selected.

generic-name Specify a generic name. Filters whose names begin with the specified characters are selected.
name Specify the name of the filter.

Examples

Example 1:

```
CPYRPTFTR FROMRPT (REPORTS/INV320) TORPT (REPORTS/INV330)
          RPTFTR (BRANCH1)
```

This command copies the filter named BRANCH1 from report INV320 to report INV330. Both reports are in library REPORTS.

Example 2:

```
CPYRPTFTR FROMRPT (REPORTS/INV320) TORPT (REPORTS/*ALL)
```

This command copies all filters from report INV320 in library REPORTS to all reports in library REPORTS.

Copy Report Subscription (CPYRPTSUB)

Where allowed to run: All environments (*ALL)

Threadsafe: No

The Copy Report Subscription (CPYRPTSUB) command copies subscriptions from one report to another.

Parameters

Keyword	Description	Choices	Notes
FROMRPT	From report	<i>Qualified object name</i>	Required, Positional 1
	Qualifier 1: From report	<i>Name</i>	
	Qualifier 2: Library	<i>Name, *LIBL, *CURLIB</i>	
TORPT	To report	<i>Qualified object name</i>	Required, Positional 2
	Qualifier 1: To report	<i>Generic name, name, *ALL</i>	
	Qualifier 2: Library	<i>Name, *LIBL, *CURLIB, *USRLIBL, *ALLUSR, *ALL</i>	
USER	User	<i>Name, *CURRENT, *CREATOR, *USRID, *CREATOR2, *ALL</i>	Optional, Positional 3
USRID	Network user	Single values: <i>*NONE, *ALL, *SPLFCRT, *SPLFOWN</i> Other values: <i>Element list</i>	Optional, Positional 4
	Element 1: User ID	<i>Character value</i>	
	Element 2: Address	<i>Character value</i>	
SUBNBR	Subscription number	1-255, <i>*ALL</i>	Optional, Positional 5

From report (FROMRPT)

Specifies the report that is the source for the copy.

This is a required parameter.

Qualifier 1: Report

name Specify the name of the report.

Qualifier 2: Library

**LIBL* All libraries in the thread's library list are searched.

**CURLIB* Use the current library for the job. If no library is specified as the current library for the job, QGPL is used.

name Specify the name of the library.

To report (TORPT)

Specifies the report that is the destination for the copy.

This is a required parameter.

Qualifier 1: Report

name Specify the name of the report.

generic-name Specify a generic name. Reports whose names begin with the specified characters are selected.

**ALL* All reports in the library or libraries are selected.

Qualifier 2: Library

**LIBL* All libraries in the thread's library list are searched.

**CURLIB* Use the current library for the job. If no library is specified as the current library for the job, QGPL is used.

**USRLIBL* Only the libraries in the user portion of the thread's library list are searched.

**ALL* All libraries in the system including QSYS are searched.

**ALLUSR* All non-system libraries on the machine are searched.

name Specify the name of the library.

User (USER)

Specifies the user who is subscribed to the report.

*CURRENT	The subscription is for the user of the current job.
*CREATOR	The subscription is for the user creating the spooled file. Report writers resolve this value using the user portion of the qualified job name that contains the spooled file.
*CREATOR2	The subscription is for the user creating the spooled file. Report writers resolve this value using information in the spooled file's attributes. Use this value if the spooled file was originally created on another system.
*USRID	The subscription is for the network user identified by the USRID parameter.
*ALL	Specifies the subscriptions for every user.
name	Specify the name of the user profile.

Network user (USRID)

Specifies the network user who is subscribed to the report. A network user receives subscriptions on the local system or on a remote system as email or through the SNADS network. For email, subscriptions are delivered as a message with the spooled file placed in an attached file. For SNADS networks, subscriptions are placed on the output queue specified in the user profile of the network user. Network users are identified by a two part user ID or by a two part distribution list ID.

A network user receives subscriptions on the local system or on a remote system as email or through the SNADS network. For email, subscriptions are delivered as a message with the spooled file placed in an attached file. For SNADS networks, subscriptions are placed on the output queue specified in the user profile of the network user. Network users are identified by a two part user ID or by a two part distribution list ID.

Single values

*NONE	The subscription is not for a network user.
*ALL	Specifies the subscriptions for every network user.
*SPLFCRT	The subscription is for the user creating the spooled file. Report writers resolve this value using information in the spooled file's attributes. Use this value if the spooled file was originally created on another system. The directory entry for the user profile is retrieved to determine the target User ID and Address.
*SPLFOWN	The subscription is for the user owning the spooled file. Report writers resolve this value using the user portion of the qualified job name that contains the spooled file. The directory entry for the user profile is retrieved to determine the target User ID and Address.

Element 1: User ID

character-value Specify the user ID (DEN) of the network user. CHAR(8)

Element 2: Address

character-value Specify the address (DGN) of the network user. CHAR(8)

Subscription number (SUBNBR)

Specifies the subscription number. Subscription numbers uniquely identify the subscriptions of an individual subscriber to a report. This allows a user or network user to subscribe to a report more than once.

Subscription numbers uniquely identify the subscriptions of an individual subscriber to a report. Subscription numbers allow a subscriber to subscribe to a report more than once.

*ALL	Specifies all subscriptions for the subscriber.
1-255	Specify a subscription number.

Examples

Example 1:

```
CPYRPTSUB FROMRPT (REPORTS/INV320) TORPT (REPORTS/INV330)
          USER (QSYSOPR) SUBNBR (2)
```

This command copies QSYSOPR's second subscription to report INV320 in library REPORTS to report INV330 in library REPORTS.

Example 2:

```
CPYRPTSUB FROMRPT (REPORTS/INV320) TORPT (REPORTS/*ALL)
          USER (*ALL) USRID (*ALL)
```

This command copies all subscriptions from report INV320 in library REPORTS to all reports in library REPORTS.

Error messages

Parameter dependencies

RDM7006	When user *USRID is specified a network user must be specified.
RDM7012	A network user or a user can be specified, but not both.
RDM7007	When network user *NONE is specified user *USRID cannot be specified.
RDM7005	When user *ALL is specified a specific network user cannot be specified.
RDM7004	When network user *ALL is specified user *USRID or user *ALL must also be specified.
RDM7003	Subscription number *ALL must be specified when user *ALL or network user *ALL is specified.

Create Form Type (CRTFRMTYP)

Where allowed to run: All environments (*ALL)

Threadsafe: No

The Create Form Type (CRTFRMTYP) command creates a form type.

Parameters

Keyword	Description	Choices	Notes
FRMTYP	Form type	<i>Character value</i>	Required, Positional 1
PHYCOPIES	Physical copies	1-9, <u>1</u>	Optional, Positional 2
TEXT	Text 'description'	<i>Character value, <u>*BLANK</u></i>	Optional, Positional 3

Form type (FRMTYP)

Specifies the name of the form type.

Note: The form type name should follow IBM i rules for valid object names. The name cannot be *ALL, *FORMS, *RPT, *SAME, or *SPLF as these are reserved parameter special values. Otherwise any character string is accepted to insure compatibility with existing printer files and programs.

This is a required parameter.

Physical copies (PHYCOPIES)

Specifies the physical copies produced by the form type.

<u>1</u>	The form produces 1 copy when printed.
1-9	Specify the number of copies produced ranging from 1 to 9.

Text 'description' (TEXT)

Specifies text that provides a brief description.

*BLANK	No text is specified.
<i>character-value</i>	Specify up to 50 characters of text enclosed in apostrophes.

Examples

Example 1:

```
CRTFRMTYP FRMTYP(STD2) PHYCOPIES(2) TEXT('Two part *STD')
```

This command creates a form type named STD2 which produces 2 physical copies when printed. STD2's text describes it as the 2 ply equivalent of *STD.

Example 2:

```
CRTFRMTYP FRMTYP(INVOICE) TEXT('Duplicate Invoice')
```

This command creates a form type named INVOICE which produces 1 physical copy when printed. INVOICE's text describes it as a duplicate invoice.

Create Report (CRTRPT)

Where allowed to run: All environments (*ALL)

Threadsafe: No

The Create Report (CRTRPT) command creates a new report.

A report is a system object containing information used by Report Manager to identify and distribute related spooled files.

- The identification information includes:
 - Selection criteria which are compared to the attributes of spooled files by Report Manager to determine which individual spooled files are an edition of the report.
 - An abstract which describes the purpose and contents of a report.
 - A subject to be used when generating email.
- The distribution information includes:
 - Subscriptions which specify report recipients and method of delivery.
 - Report filters which specify page selection criteria for decollating.
 - Specifications for printing such as defaults for form type, copies, and output queue.
 - The name of a user process program to handle unique processing needs.
 - The name of a library to receive archives containing the report's spooled files.
 - Specifications for other processing such as delivery point, hold status, report group, transform, send format, and whether or not subscriptions are allowed.

Much of the distribution information can be specified on the report and overridden by the values specified on individual subscriptions.

Parameters

Keyword	Description	Choices	Notes
RPT	Report	<i>Qualified object name</i>	Required, Positional 1
	Qualifier 1: Report	<i>Name</i>	
	Qualifier 2: Library	<i>Name, *CURLIB</i>	
FRMTYP	Form type	<i>Character value, *SPLF</i>	Optional, Positional 2
COPIES	Copies	1-255, *SPLF, *RPTSUB	Optional, Positional 3
ALWRPTSUB	Allow report subscriptions	*NO, *YES	Optional, Positional 4
GROUP	Report group	<i>Name, *NONE</i>	Optional, Positional 5
DELIVERY	Delivery point	<i>Character value, *NONE</i>	Optional, Positional 6
TEXT	Text 'description'	<i>Character value, *BLANK</i>	Optional, Positional 7
OMITZERO	Omit zero page delivery	*YES, *NO	Optional, Positional 8
DLVSTS	Deliver status	*READY, *HELD	Optional, Positional 9
SNDFMT	Send format	*ALLDATA, *RCDDATA, *EMAIL	Optional, Positional 10
SUBJECT	Subject	<i>Character value, *DEFAULT, *RPTFTR, *ACGCDE, *PRTTXT, *USRDTA, *NONE</i>	Optional, Positional 11
TRANSFORM	Transform to perform	<i>Character value, *TXT, *PDFLETTER, *PDFLEGAL, *PDFA4, *RTFLETTER, *RTFLEGAL, *RTFA4</i>	Optional, Positional 12
MSGUSEABST	Use abstract as message	*NO, *YES	Optional, Positional 13
OUTQ	Destination output queue	Single values: *WTR, *DEV, *USRPRF, *JOB Other values: <i>Qualified object name</i>	Optional, Positional 14
	Qualifier 1: Destination output queue	<i>Name</i>	
	Qualifier 2: Library	<i>Name, *LIBL, *CURLIB</i>	

PRTDEV	Printer device	<i>Name</i> , *SYSVAL, *USRPRF, * <u>NONE</u>	Optional, Positional 15
HOLD	Hold	* <u>NO</u> , *YES	Optional, Positional 16
SELECT	Select spooled files with	<i>Element list</i>	Optional, Positional 17
	Element 1: Program that opened file	Single values: * <u>RPT</u> , *ALL, *BLANK Other values: <i>Qualified object name</i>	
	Qualifier 1: Program that opened file	<i>Generic name, name</i>	
	Qualifier 2: Library	<i>Name</i> , * <u>ALL</u>	
	Element 2: Spooled file name	<i>Generic name, name</i> , * <u>ALL</u>	
	Element 3: User data	<i>Character value</i> , * <u>ALL</u>	
	Element 4: Job name	<i>Generic name, name</i> , * <u>ALL</u>	
	Element 5: Form type	<i>Character value</i> , * <u>ALL</u>	
	Element 6: User	<i>Generic name, name</i> , * <u>ALL</u>	
	Element 7: Accounting code	<i>Character value</i> , * <u>ALL</u>	
	Element 8: Print text	<i>Character value</i> , * <u>ALL</u>	
	Element 9: Printer device type	* <u>ALL</u> , *AFPDS, *AFPDSLIN, *IPDS, *LINE, *SCS, *USERASCII	
	Element 10: Output queue	Single values: * <u>ALL</u> Other values: <i>Qualified object name</i>	
	Qualifier 1: Output queue	<i>Name</i>	
	Qualifier 2: Library	<i>Name</i> , * <u>ALL</u>	
	Element 11: Device file	Single values: * <u>ALL</u> Other values: <i>Qualified object name</i>	
	Qualifier 1: Device file	<i>Name</i>	
	Qualifier 2: Library	<i>Name</i> , * <u>ALL</u>	
	Element 12: Front overlay	Single values: * <u>ALL</u> Other values: <i>Qualified object name</i>	
	Qualifier 1: Front overlay	<i>Name</i>	
	Qualifier 2: Library	<i>Name</i> , * <u>ALL</u>	
	Element 13: Back overlay	Single values: * <u>ALL</u> Other values: <i>Qualified object name</i>	
	Qualifier 1: Back overlay	<i>Name</i>	
	Qualifier 2: Library	<i>Name</i> , * <u>ALL</u>	
	Element 14: Form definition	Single values: * <u>ALL</u> Other values: <i>Qualified object name</i>	
	Qualifier 1: Form definition	<i>Name</i>	
	Qualifier 2: Library	<i>Name</i> , * <u>ALL</u>	
	Element 15: Page definition	Single values: * <u>ALL</u> Other values: <i>Qualified object name</i>	
	Qualifier 1: Page definition	<i>Name</i>	
	Qualifier 2: Library	<i>Name</i> , * <u>ALL</u>	
	Element 16: Minimum pages	<i>Integer</i> , * <u>NOMIN</u>	
	Element 17: Maximum pages	<i>Integer</i> , * <u>NOMAX</u>	
	Element 18: Spooled file number	<i>Integer</i> , * <u>ALL</u>	
SELECTSEQ	Selection processing sequence	1-9999, * <u>5000</u>	Optional, Positional 18
USRPRCPGM	User process program	Single values: * <u>NONE</u> Other values: <i>Qualified object name</i>	Optional, Positional 19
	Qualifier 1: User process program	<i>Name</i>	
	Qualifier 2: Library	<i>Name</i> , * <u>LIBL</u> , *CURLIB	
ABSTRACT	Abstract	<i>Character value</i>	Optional, Positional 20
AUT	Authority	<i>Name</i> , * <u>LIBCRTAUT</u> , *CHANGE, *ALL, *USE, *EXCLUDE	Optional, Positional 21
ARCLIB	Library to receive archive	<i>Name</i> , * <u>WTR</u> , *NONE	Optional, Positional 22

Report (RPT)

Specifies the name of the report and the library where it resides.

This is a required parameter.

Qualifier 1: Report

name Specify the name of the report.

Qualifier 2: Library

***CURLIB** Use the current library for the job. If no library is specified as the current library for the job, QGPL is used.
name Specify the name of the library.

Form type (FRMTYP)

Specifies the form type on which to print the report. The form type may be overridden by a subscription.

***SPLF** Print on the form type specified by the report's spooled file.
name Specify the name of the form type.

Copies (COPIES)

Specifies the number of copies of the form type to print or send.

This is the number of copies that print in addition to those specified on subscriptions. If there are no subscriptions, this is the number of copies to print.

***RPTSUB** The number of copies specified by the report's subscriptions are printed. The copies parameter specified on the spooled file is ignored. If the report does not have any subscriptions ***RPTSUB** is treated as ***SPLF**.
***SPLF** The number of copies specified by the report's spooled file are printed. These copies are in addition to copies specified on the report's subscriptions if any.
1-255 Specify the number of identical copies to print.

Allow report subscriptions (ALWRPTSUB)

The Allow report subscriptions parameter determines whether or not the report can have subscriptions added to it by the Add Report Subscription (ADDRPTSUB) command. Changing the Allow report subscriptions parameter does not affect subscriptions that already exist for the report.

***YES** Subscriptions can be added to this report.
***NO** Subscriptions cannot be added to this report.

Report group (GROUP)

Specifies the report's Report group.

A report group is a collection of related or similar reports. Report groups provide a means of segregating printed output. Report groups can have any name and any meaning desired. For an installation with many applications, report groups might be the name of the application the report belongs to such as "INVENTORY" or "ACCOUNTING". At another installation, report groups might be the name of the process that produces the report such as "MONTHEND" or "NIGHTLY".

***NONE** No report group is specified.
name Specify the name of the report group.

Delivery point (DELIVERY)

Specifies the Delivery point for the report.

A delivery point is a named external destination. Delivery points refine and further subdivide the destination of a report or a subscription beyond what is possible by designating output queue alone. Delivery points can have any name and any meaning desired. For an installation with a large central print facility, delivery points might be the names of bins the print operator places the printed output into. At another installation, delivery points might be the

office, room, floor or building numbers to which the printed output is delivered. A delivery point can be specified on reports and on subscriptions with subscriptions having precedence.

***NONE** No delivery point is specified.
name Specify the name of the delivery point.

Text 'description' (TEXT)

Specifies text that provides a brief description.

***BLANK** No text is specified.
character-value Specify up to 50 characters of text enclosed in apostrophes.

Omit zero page delivery (OMITZERO)

Specifies how delivery should be handled when a page filter selects zero pages from a spooled file (when no pages match a filter's criteria).

***YES** Omit the delivery when a filter selects zero pages from a spooled file.
***NO** Do not omit the delivery even though zero pages are selected from the spooled file.

Deliver status (DLVSTS)

Specifies the status a spooled file has when it is delivered.

***READY** Spooled files are delivered with a status of ready.
***HELD** Spooled files are delivered with a status of held.

Send format (SNDFMT)

Specifies the format in which the spooled file is sent to a network user.

***ALLDATA** Spooled files are delivered using the Send Net Spooled File (SNDNETSPLF) command with DTAFMT(*ALLDATA).
***RCDDATA** Spooled files are delivered using the Send Net Spooled File (SNDNETSPLF) command with DTAFMT(*RCDDATA).
***EMAIL** Spooled files are delivered as Email.

Subject (SUBJECT)

Specifies the subject for email generated by subscriptions to the report.

***DEFAULT** The subject of the email is generated from spooled file attributes.
***RPTFTR** The subject of the email is the report's name followed by the filter's name.
***ACGCDE** The subject of the email is the accounting code of the job that created the spooled file.
***PRTTXT** The subject of the email is the spooled file's print text attribute.
***USRDTA** The subject of the email is the spooled file's user data attribute.
***NONE** No subject is included in the email.
character-value Specify the subject of the email.

Transform to perform (TRANSFORM)

Specifies the manner in which the spooled file is transformed when Report Manager is integrated with SpoolMail or Spool-a-Matic. If these products are not installed the value is ignored.

***TXT** Spooled files are transformed using the built in Report Manager support.
transform Specify any of the **SpoolMail** or **Spool-a-Matic** transforms.

Use abstract as message (MSGUSEABST)

Specifies that the report's abstract should be used as the body of generated email messages.

- *NO** Do not use the report's abstract as the message, a default is generated.
- *YES** Use the report's abstract as the message.

Destination output queue (OUTQ)

Specifies the name of an output queue to which spooled files are delivered by a report writer. This parameter follows the rules of the OUTQ parameter of printer device files, job descriptions, user profiles and display devices outlined in *iSeries Printer Device Programming SC41-5713*.

Single values

- *WTR** The destination is determined at the time a report writer is delivering spooled files. If the report writer is started with a printer device specified on the DEV parameter then the spooled file is printed. If DEV(*NONE) is specified when the report writer is started then the default destination queue (DFTOUTQ) parameter is used as the destination.
- *DEV** The output queue associated with the printer device is used.
- *USRPRF** The output queue specified in the user profile of the creator of the spooled file is used.
- *JOB** The output queue of the job that created the spooled file is used.

Qualifier 1: Output queue

- name** Specify the name of the output queue.

Qualifier 2: Library

- *LIBL** All libraries in the thread's library list are searched.
- *CURLIB** Use the current library for the job. If no library is specified as the current library for the job, QGPL is used.
- name** Specify the name of the library.

Printer device (PRTDEV)

Specifies the name of a printer device description to which spooled files are delivered by a report writer. This parameter follows the rules of the DEV parameter of printer device files, job descriptions, user profiles and display devices outlined in *iSeries Printer Device Programming SC41-5713*.

- *NONE** Spooled files are not delivered to a printer device.
- *SYSVAL** The printer device named in the QPRTDEV system value is used.
- *USRPRF** The printer device specified in the user profile of the creator of the spooled file is used.
- name** Specify the name of the printer device to use.

Hold (HOLD)

Specifies whether the report is held.

A held report is ineligible for processing by report writers. When a report writer encounters one of the report's spooled files the spooled file is held. None of the actions the report specifies are taken. None of the report's subscriptions are delivered. The report is held until a Release Report (RLSRPT) command is issued.

Note: Reports and report subscriptions can both be held. When a report is held, report writers hold the spooled file without further processing. When a report subscription is held, report writers skip the processing specified by that subscription only. All other processing is performed.

- *NO** The report is not held.
- *YES** The report is held.

Select spooled files with (SELECT)

Specifies the selection criteria which identify the report. Selection criteria consist of 18 elements.

The select spooled file parameter is a set of criterion that allows a report writer to identify report editions. It is made up of 18 elements which are matched against the corresponding attributes of a spooled file. A spooled file whose attributes match all of the selection criteria is identified as an edition of the report.

Element 1: Program that opened file

Single values	*RPT	Only spooled files created by a program with the same name as the report are selected. When the program name is compared the program library is not considered.
	*ALL	Select spooled files with all values. This criterion does not distinguish editions of the report.
	*BLANK	Spooled files whose creating program name is left blank are selected. Many IBM programs such as query omit the program name.
Qualifier 1: Program	generic-name	Specify a generic name. Spooled files whose creating program name begins with the specified characters are selected.
	name	Specify the program name that creates editions of the report.
Qualifier 2: Library	*ALL	Select spooled files with all values. The library name does not distinguish editions of the report.
	name	Specify the qualifying library name that distinguishes editions of the report.

Element 2: Spooled file name

*ALL	Select spooled files with all values. This criterion does not distinguish editions of the report.
name	Specify the spooled file name that identifies editions of the report.
generic-name	Specify a generic name. Spooled files whose name begins with the specified characters are selected.

Element 3: User data

*ALL	Select spooled files with all values. This criterion does not distinguish editions of the report.
character-value	Specify the spooled file user data that identifies editions of the report.

Element 4: Job name

*ALL	Select spooled files with all values. This criterion does not distinguish editions of the report.
name	Specify the job name that identifies editions of the report.
generic-name	Specify a generic name. Spooled files whose job name begins with the specified characters are selected.

Element 5: Form type

*ALL	Select spooled files with all values. This criterion does not distinguish editions of the report.
name	Specify the form type that distinguishes editions of the report.

Element 6: User

*ALL	Select spooled files with all values. This criterion does not distinguish editions of the report.
name	Specify the user name that identifies editions of the report.
generic-name	Specify a generic name. Spooled files created by user names beginning with the specified characters are selected.

Element 7: Accounting code

*ALL	Select spooled files with all values. This criterion does not distinguish editions of the report.
character-value	Specify the accounting code that identifies editions of the report.

Element 8: Print text

*ALL	Select spooled files with all values. This criterion does not distinguish editions of the report.
print-text	Specify the print text that identifies editions of the report.

Element 9: Printer device type

Printer device type specifies the type of printer data stream contained in the spooled file.

*ALL	Select spooled files with all values. This criterion does not distinguish editions of the report.
*AFPDS	Only spooled files containing an Advanced Function Printing Data Stream are selected by this report.
*AFPDSLIN	Only spooled files containing an AFPDS data mixed with 1403 line data are selected by this report.
*IPDS	Only spooled files containing an Intelligent Printer Data Stream are selected by this report.
*LINE	Only spooled files containing 1403 line data are selected by this report.
*SCS	Only spooled files containing an SNA Character Stream data stream are selected by this report.
*USERASCII	Only spooled files containing an ASCII data stream are selected by this report.

Element 10: Output queue

Output queue specifies the output queue that must contain the spooled file in order to be selected by this report.

Single values	*ALL	Select spooled files with all values. This criterion does not distinguish editions of the report.
Qualifier 1: Output queue	name	Specify the output queue that identifies editions of this report.
Qualifier 2: Library	*ALL	Select spooled files with all values. The library name does not distinguish editions of the report.
	name	Specify the qualifying library name that distinguishes editions of the report.

Element 11: Device file

Single values	*ALL	Select spooled files with all values. This criterion does not distinguish editions of the report.
Qualifier 1: Device file	name	Specify the device file that is used to create editions of the report.
Qualifier 2: Library	*ALL	Select spooled files with all values. The library name does not distinguish editions of the report.
	name	Specify the qualifying library name that distinguishes editions of the report.

Element 12: Front overlay

Single values	*ALL	Select spooled files with all values. This criterion does not distinguish editions of the report.
Qualifier 1: Front overlay	name	Specify the front overlay that is used to create editions of the report.
Qualifier 2: Library	*ALL	Select spooled files with all values. The library name does not distinguish editions of the report.
	name	Specify the qualifying library name that distinguishes editions of the report.

Element 13: Back overlay

Single values	*ALL	Select spooled files with all values. This criterion does not distinguish editions of the report.
Qualifier 1: Back overlay	name	Specify the back overlay that is used to create editions of the report.
Qualifier 2: Library	*ALL	Select spooled files with all values. The library name does not distinguish editions of the report.
	name	Specify the qualifying library name that distinguishes editions of the report.

Element 14: Form definition

Single values	*ALL	Select spooled files with all values. This criterion does not distinguish editions of the report.
Qualifier 1: Form definition	name	Specify the form definition that is used to create editions of the report.
Qualifier 2: Library	*ALL	Select spooled files with all values. The library name does not distinguish editions of the report.
	name	Specify the qualifying library name that distinguishes editions of the report.

Element 15: Page definition

Single values	*ALL	Select spooled files with all values. This criterion does not distinguish editions of the report.
----------------------	-------------	---

Qualifier 1: Page definition	name	Specify the page definition that is used to create editions of the report.
Qualifier 2: Library	*ALL	Select spooled files with all values. The library name does not distinguish editions of the report.
	name	Specify the qualifying library name that distinguishes editions of the report.

Element 16: Minimum pages

*NOMIN	Select spooled files with all values. A minimum number of pages to print does not distinguish editions of the report.
integer	Only spooled files containing this number of pages or more are selected by this report.

Element 17: Maximum pages

*NOMAX	Select spooled files with all values. A maximum number of pages to print does not distinguish editions of the report.
integer	Only spooled files containing this number of pages or fewer are selected by this report.

Element 18: Spooled file number

*ALL	Select spooled files with all values. This criterion does not distinguish editions of the report.
1-999999	Specify the spooled file number that identifies editions of the report.

Selection processing sequence (SELECTSEQ)

Specifies the sequence in which the report is processed.

5000	The report is processed after those with sequence numbers 1 through 4999 and before those with sequence numbers 5001 through 9999.
1-9999	Specify a selection sequence.

User process program (USRPRCPGM)

Specifies the name of the user process program.

A user process program is a user written program that is given control by a report writer to perform functions not supplied by Report Manager. User process programs can be specified for a report and as the destination of subscriptions. A user process program specified for a report is given control after the report has been identified, and before any subscription staging has been performed. User process programs specified on subscriptions are given control after all subscriptions have been staged and before other subscriptions are delivered.

Report writers pass 2 parameters to user process programs, a spooled file attribute record and a log entry buffer.

spooled-file-attribute-record	The attribute record contains specific information about the spooled file to process. The format of the record is identical to format SPLA0200 returned by system interface program QUSRSPLA. For the layout of this record and a complete discussion of its content see the <i>Programming > Application programming interfaces > QUSRSPLA - Retrieve Spooled File Attributes</i> topic in the IBM i Information Center at http://publib.boulder.ibm.com/series/ .
log-entry-buffer	<p>The log entry buffer contains data from the report distribution log. The data has one of two formats depending on whether a report or a subscription is being processed:</p> <ul style="list-style-type: none"> • When the user process program is called because it was named on USRPRCPGM parameter of a report it is passed a report log entry. <ul style="list-style-type: none"> ○ A report log entry is identified by a record ID of "E" in the first position of the log buffer. ○ The format of the entry is identical to that of record RMEVTR in file RMEVT. For the layout of this record use the Display File Field Description (DSPFFD) command. • When the user process program is called because it was named in the USRPRCPGM parameter as a subscription's destination, it is passed a subscription log entry. <ul style="list-style-type: none"> ○ A subscription log entry is identified by a record ID of "D" in the first position of the log buffer. ○ The format of the entry is identical to that of record RMDSTR in file RMDST. For the layout of this record use the Display File Field Description (DSPFFD) command.

Any escape messages received by the report writer from the user process program are added to the report distribution log.

Note: Report Manager includes example programs with source code. Check the source file RMSOURCE and a current PTF list.

Single values

***NONE** No program is called by a report writer.

Qualifier 1: User process program

name Specify the name of the program which is called by a report writer.

Qualifier 2: Library

***LIBL** All libraries in the thread's library list are searched.

***CURLIB** Use the current library for the job. If no library is specified as the current library for the job, QGPL is used.

name Specify the name of the library.

Abstract (ABSTRACT)

Specifies an abstract of the report.

An abstract gives a brief overview of the contents of a report. It may also be used to refer the reader to other documentation for a more detailed explanation of the report.

character-value Specify an abstract of the report's content.

Authority (AUT)

Specifies the authority you are giving to users who do not have specific authority to the object, who are not on the authorization list, or whose group has no specific authority to the object.

***LIBCRTAUT** The authority for the object is the same as the value specified on the **Create authority** prompt (CRTAUT parameter) of the library in which the object is being created. If the value specified on the **Create authority** prompt (CRTAUT parameter) is changed, the new value will not affect any existing objects.

***CHANGE** Change authority allows the user to perform basic functions on the object, however, the user cannot change the object. Change authority provides object operational authority and all data authority.

***ALL** The user can perform all operations except those limited to the owner or controlled by authorization list management authority. The user can control the object's existence, specify the security for the object, change the object, and perform basic functions on the object. The user cannot transfer ownership of the object.

***USE** Use authority provides object operational authority and read authority.

***EXCLUDE** Exclude authority prevents the user from accessing the object.

name Specify the name of an authorization list to be used for authority to the object. Users included in the authorization list are granted authority to the object as specified in the list. The authorization list must exist when the object is created.

Library to receive archive (ARCLIB)

Specifies the library that receives the archives created by report writers for each spooled file processed.

Note: A "Library to receive archive" (ARCLIB) parameter is provided on both reports and report writers. When both are specified, the report takes precedence.

***WTR** Use the library specified on the Start Report Writer (STRRPTWTR) command.

***NONE** Report writers do not create an archive from each spooled file processed.

name Specify the name of the library.

Examples

Example 1:

```
CRTRPT RPT (REPORTS/INV320)
```

This command creates a report named INV320 in library REPORTS. Spooled files of this report are identified by a creating program name of INV320. Form type is determined by the spooled file, copies are determined by subscriptions and the destination is determined by the report writer unless otherwise specified on subscriptions.

Example 2:

```
CRTRPT RPT (REPORTS/AP1099SUM) DELIVERY (BIN5)
      SELECT (AP1099 APSUM)
CRTRPT RPT (REPORTS/AP1099DET) DELIVERY (BIN5)
      SELECT (AP1099 APDET)
```

These commands create two reports named AP1099SUM and AP1099DET in library REPORTS. Program AP1099 creates spooled files for both reports. To distinguish between the spooled files created by program AP1099, the selection criteria for report AP1099SUM includes the spooled file name APSUM while the selection criteria for AP1099DET include the spooled file name APDET. Both reports are printed for delivery to bin 5 unless otherwise specified on subscriptions.

Example 3:

```
CRTRPT RPT (REPORTS/BIGQUERY) ALWRPTSUB (*NO)
      COPIES (*SPLF) OUTQ (QPRINT)
      TEXT ('Route large queries to system printer')
      SELECT (*ALL QPQUPRFIL *ALL *ALL *ALL *ALL *ALL *ALL *ALL
      *ALL *ALL *ALL *ALL *ALL *ALL *ALL 100) SELECTSEQ (1)
```

This command creates a report named BIGQUERY in library REPORTS. The report is used to direct spooled files created by Query to a system printer when they exceed 100 pages. Query can be identified by spooled file name QPQUPRFIL. Spooled files of less than 100 pages are not selected by this report since the minimum pages are set to 100. Since this report is meant to preempt others, it is given a low sequence number. Because the report is intended as a general routing not related to a specific Query definition report subscriptions are not allowed and copies are determined by the spooled file.

Error messages

Parameter dependencies

RDM7025	A printer device is required when output queue *DEV is specified.
RDM7026	When a printer device is specified output queue *DEV is required.
RDM7027	Subscriptions must be allowed when *RPTSUB is specified for copies.

Create Spool Save File (CRTSPLSAVF)

Where allowed to run: All environments (*ALL)

Threadsafe: No

The Create Spool Save File (CRTSPLSAVF) command creates a save file containing a spooled file and all its related resources. The save file is suitable for emailing with a problem report.

Parameters

Keyword	Description	Choices	Notes
FILE	Spooled file name	<i>Name</i>	Required, Positional 1
SAVF	Save file	<i>Qualified object name</i>	Required, Positional 2
	Qualifier 1: Save file	<i>Name</i>	
	Qualifier 2: Library	<i>Name</i> , * CURLIB	
JOB	Job name	Single values: * Other values: <i>Qualified job name</i>	Optional
	Qualifier 1: Job name	<i>Name</i>	
	Qualifier 2: User	<i>Name</i>	
	Qualifier 3: Number	000000-999999	
SPLNBR	Spooled file number	1-999999, *ONLY, * LAST	Optional
SAVRSC	Save resources	* YES , *NO, Y, N	Optional
MSG	Message	<i>Character value</i> , * NONE	Optional

Spooled file name (FILE)

Specifies the name of the spooled file to process. CHAR(10)

This is a required parameter.

name Specify the name of the spooled file.

Save file (SAVF)

Specifies the name of the save file that is used to contain spooled file data. The saved file must not exist and will be created by the command.

This is a required parameter.

Qualifier 1: Save file

name Specify the save file name.

Qualifier 2: Library

***CURLIB** Use the current library for the job. If no library is specified as the current library for the job, QGPL is used.

name Specify the name of the library.

Job name (JOB)

Specifies the job that contains the spooled file.

Single values

***** The job that issued the command.

Qualifier 1: Job name

name Specify the name of the job. CHAR(10)

Qualifier 2: User

name Specify the name that identifies the user profile under which the job is run. CHAR(10)

Qualifier 3: Number

000000-999999 Specify the system assigned job number. CHAR(6)

Spooled file number (SPLNBR)

Specifies the number of the spooled file. INT(4)

***LAST** The highest numbered spooled file with the specified file name is used.
***ONLY** The number of the only spooled file with the specified file name is used.
1-999999 Specify the number of the spooled file.

Save resources (SAVRSC)

Specifies if external resource such as overlays and page segments are included in the save file.

***YES** Resources are saved.
***NO** Resources are not saved.

Message (MSG)

Specifies a short message to include in the save file.

***NONE** No message is included.
character-value Specify a short message to include in the save file.

Examples

Example 1:

```
CRTSPLSAVF FILE(QSYSPRT) SAVF(QGPL/PRBRPT)
```

This command creates save file PRBRPT in library QGPL. The last spooled file named QSYSPRT is saved along with its resources. The current job is searched to locate the file.

Example 2:

```
CRTSPLSAVF FILE(QPQUPRFIL) SAVF(NEWPRB) SPLNBR(3)
```

The file named QPQUPRFIL, which is spooled file number 3 in the job executing this command, is saved to save file NEWPRB. The save file is placed in job's *CURLIB.

Convert Report Release (CVTRPTRLs)

Where allowed to run: All environments (*ALL)

Threadsafe: No

The Convert Report Release (CVTRPTRLs) command converts the internal arrangement of one or more reports to that of the current release. Reports created by Report Manager releases V2R2M2 or earlier have a different internal arrangement and cannot be used with releases after V2R2M2 unless they are converted.

An old report is automatically converted when a new release of Report Manager first opens it and finds the old format. You can perform this processing in advance of using Report Manager and avoid potential authority problems by running the command:

```
CVTRPTRLs RPT (*ALL/*ALL)
```

During the conversion process a new report with the same name, library, public and private authorizations (but possibly a different owner) is created. The old report is placed in the QRPLOBJ library, and information is then copied from the old report to the new report. **YOU ARE STRONGLY URGED TO MAKE A BACKUP OF THE REPORTS BEFORE RUNNING THIS COMMAND. IF THE SYSTEM ENDS ABNORMALLY DURING THE CONVERSION THE REPORTS MAY BE DAMAGED AND DATA LOST.**

Parameters

Keyword	Description	Choices	Notes
RPT	Report	<i>Qualified object name</i>	Required, Positional 1
	Qualifier 1: Report	<i>Generic name, name, *ALL</i>	
	Qualifier 2: Library	<i>Name, *LIBL, *CURLIB, *USRLIBL, *ALLUSR, *ALL</i>	

Report (RPT)

Specifies the name of the report and the library where it resides.

This is a required parameter.

Qualifier 1: Report

- name*** Specify the name of the report.
- generic-name*** Specify a generic name. Reports whose names begin with the specified characters are selected.
- *ALL** All reports in the library or libraries are selected.

Qualifier 2: Library

- *LIBL** All libraries in the thread's library list are searched.
- *CURLIB** Use the current library for the job. If no library is specified as the current library for the job, QGPL is used.
- *USRLIBL** Only the libraries in the user portion of the thread's library list are searched.
- *ALL** All libraries in the system including QSYS are searched.
- *ALLUSR** All non-system libraries on the machine are searched.
- name*** Specify the name of the library.

Examples

Example 1:

```
CVTRPTRLs RPT (REPORTS/INV320)
```

This command converts the internal arrangement of a report named INV320 in library REPORTS if it was created by release V2R2M2 or earlier.

Example 2:

```
CVTRPTRLs RPT (REPORTS/INV*)
```

This command converts all reports in library REPORTS whose names begin with "INV".

Example 3:

```
CVTRPTRL S  RPT (*ALL/INV*)
```

This command converts all reports whose names begin with "INV" from all libraries on the system.

Delete Form Type (DLTFRMTYP)

Where allowed to run: All environments (*ALL)

Threadsafe: No

The Delete Form Type (DLTFRMTYP) command deletes one or more form types.

Parameters

Keyword	Description	Choices	Notes
FRMTYP	Form type	Character value, *ALL	Required, Positional 1

Form type (FRMTYP)

Specifies the name of the form type.

This is a required parameter.

<i>name</i>	Specify the name of the form type.
<i>generic-name</i>	Specify a generic name. Form types whose names begin with the specified characters are selected.
*ALL	All form type names are selected.

Examples

Example 1:

```
DLTFRMTYP FRMTYP (STD2)
```

This command deletes a form type named STD2.

Example 2:

```
DLTFRMTYP FRMTYP (STD*)
```

This command deletes all form types whose names begin with "STD".

Example 3:

```
DLTFRMTYP FRMTYP (*ALL)
```

This command deletes all form types known to Report Manager.

Delete Report (DLTRPT)

Where allowed to run: All environments (*ALL)

Threadsafe: No

The Delete Report (DLTRPT) command deletes one or more reports.

Parameters

Keyword	Description	Choices	Notes
RPT	Report	<i>Qualified object name</i>	Required, Positional 1
	Qualifier 1: Report	<i>Generic name, name, *ALL</i>	
	Qualifier 2: Library	<i>Name, *LIBL, *CURLIB, *USRLIBL, *ALLUSR, *ALL</i>	

Report (RPT)

Specifies the name of the report and the library where it resides.

This is a required parameter.

Qualifier 1: Report

- name*** Specify the name of the report.
- generic-name*** Specify a generic name. Reports whose names begin with the specified characters are selected.
- *ALL** All reports in the library or libraries are selected.

Qualifier 2: Library

- *LIBL** All libraries in the thread's library list are searched.
- *CURLIB** Use the current library for the job. If no library is specified as the current library for the job, QGPL is used.
- *USRLIBL** Only the libraries in the user portion of the thread's library list are searched.
- *ALL** All libraries in the system including QSYS are searched.
- *ALLUSR** All non-system libraries on the machine are searched.
- name*** Specify the name of the library.

Examples

Example 1:

```
DLTRPT RPT (REPORTS/INV320)
```

This command deletes a report named INV320 in library REPORTS.

Example 2:

```
DLTRPT RPT (REPORTS/INV*)
```

This command deletes all reports in library REPORTS whose names begin with "INV".

Example 3:

```
DLTRPT RPT (*ALL/INV*)
```

This command deletes all reports whose names begin with "INV" from all libraries on the system.

Dump Page Index Positions (DMPPIP)

Where allowed to run: All environments (*ALL)

Threadsafe: No

The Dump Page Index Positions (DMPPIP) command prints the line and position values, for data found in the spooled file, as calculated by the software. These are used to specify data selection criteria for the spooled file.

Parameters

Keyword	Description	Choices	Notes
FILE	Spooled file name	<i>Name</i> , *LASTCRT	Required, Positional 1
JOB	Job name	Single values: * Other values: <i>Qualified job name</i>	Optional, Positional 2
	Qualifier 1: Job name	<i>Name</i>	
	Qualifier 2: User	<i>Name</i>	
	Qualifier 3: Number	000000-999999	
SPLNBR	Spooled file number	1-999999, *ONLY, * LAST	Optional, Positional 3
PAGERANGE	Page range to print	<i>Element list</i>	Optional, Positional 4
	Element 1: Starting page	<i>Integer</i> , 1 , *ENDPAGE	
	Element 2: Ending page	<i>Integer</i> , * END	

Spooled file name (FILE)

Specifies the name of the spooled file to process. CHAR(10)

This is a required parameter.

***LASTCRT** The last spooled file created by the current job or thread is identified using the QSPRILSP API and processed. This is useful for jobs that create spooled files under other user profiles, which consequently end up in the user's QPRTJOB. When *LASTCRT is specified, the JOB() and SPLNBR() parameters are ignored.

name Specify the name of the spooled file.

Job name (JOB)

Specifies the job that contains the spooled file.

Single values

***** The job that issued the command.

Qualifier 1: Job name

name Specify the name of the job. CHAR(10)

Qualifier 2: User

name Specify the name that identifies the user profile under which the job is run. CHAR(10)

Qualifier 3: Number

000000-999999 Specify the system assigned job number. CHAR(6)

Spooled file number (SPLNBR)

Specifies the number of the spooled file. INT(4)

***LAST** The highest numbered spooled file with the specified file name is used.

***ONLY** The number of the only spooled file with the specified file name is used.

1-999999 Specify the number of the spooled file.

Page range to print (PAGERANGE)

Specifies the starting and ending pages to process.

Element 1: Starting page

<u>1</u>	Processing begins at page 1.
*ENDPAGE	The starting page to print is the ending page to print. Only the ending page is printed.
<i>integer</i>	Specify the starting page.

Element 2: Ending page

*END	Processing continues until the end of file.
<i>integer</i>	Specify the ending page.

Examples

Example 1:

```
DMPPIP      FILE(QSYSPRT)
             JOB(033194/QPGMR/MONTHEND) SPLNBR(2)
```

This command dumps data position information for spooled file number 2, QSYSPRT, from job 033194/QPGMR/MONTHEND.

Example 2:

```
DMPPIP      FILE(QSYSPRT) PAGERANGE(3 4)
```

This command dumps data position information for the last spooled file with name QSYSPRT from the job running the command. Only the data for pages 3 and 4 is dumped.

Display Mail Log (DSPMAILLOG)

Where allowed to run: All environments (*ALL)

Threadsafe: No

The Display Mail Log (DSPMAILLOG) command shows the system mail log (IBM i journal QZMF). The mail log contains information about the processing of mail.

Note: Mail journaling must be turned on. To turn on mail journaling, specify JOURNAL(*YES) on the CHGSMTPA command. Only journal receivers in the current chain are searched.

Parameters

Keyword	Description	Choices	Notes
PERIOD	Time period	<i>Element list</i>	Optional, Positional 1
	Element 1: Starting time and date	<i>Element list</i>	
	Element 1: Starting time	<i>Time, *AVAIL</i>	
	Element 2: Starting date	<i>Date, *CURRENT, *BEGIN</i>	
	Element 2: Ending time and date	<i>Element list</i>	
	Element 1: Ending time	<i>Time, *AVAIL</i>	
OUTPUT	Element 2: Ending date	<i>Date, *CURRENT, *END</i>	Optional, Positional 2
	Output	<i>*, *PRINT</i>	
		<i>_, *PRINT</i>	

Time period (PERIOD)

Specifies the period of time for which the logged message data is shown. This parameter contains two lists of two elements each.

Element 1: Starting time and date

Element 1: Starting time One of the following specifies the starting time from which entries are shown. Entries logged before this time on the **Starting date** are not shown.

***AVAIL**
time

All data that is available for the specified date is shown.

Specify the start time from which data for the specified date is shown. The time is specified in 24-hour format and can be specified with or without a time separator:

- Without a time separator, specify a string of 4 or 6 digits (hhmm or hhmmss) where hh = hours, mm = minutes, and ss = seconds.
- With a time separator, specify a string of 5 or 8 digits where the time separator specified for your job is used to separate the hours, minutes, and seconds. If you enter this command from the command line, the string must be enclosed in apostrophes. If a time separator other than the separator specified for your job is used, this command will fail.

Element 2: Starting date One of the following specifies the starting date from which entries are shown. Entries logged before this date are not shown.

***CURRENT**
***BEGIN**
date

The current date is used.

The data from the beginning of the log is shown.

Specify the start date from which data is shown. The date must be specified in the job date format.

Element 2: Ending time and date

Element 1: Ending time One of the following specifies the ending time to which entries are shown. Entries logged after this time on the **Ending date** are not shown.

***AVAIL**
time

All data that is available for the specified date is shown.

Specify the end time to which data for the specified date is shown. The time is specified in 24-hour format and can be specified with or without a time separator:

- Without a time separator, specify a string of 4 or 6 digits (hhmm or hhmmss) where hh = hours, mm = minutes, and ss = seconds.
- With a time separator, specify a string of 5 or 8 digits where the time separator specified for your job is used to separate the hours, minutes, and

seconds. If you enter this command from the command line, the string must be enclosed in apostrophes. If a time separator other than the separator specified for your job is used, this command will fail.

Element 2: Ending date One of the following specifies the ending date to which entries are shown. Entries logged after this date are not shown.

*CURRENT	The current date is used.
*END	The data to the end of the log is shown.
date	Specify the end date to which data is shown. The date must be specified in the job date format.

Output (OUTPUT)

Specifies where the output from the command is sent. CHAR(10)

*	The output is displayed (if requested by an interactive job) or printed with the job's spooled output (if requested by a batch job).
*PRINT	The output is printed with the job's spooled output.

Examples

Example 1:

```
DSPMAILLOG
```

The mail log entries for today are displayed on the screen.

Example 2:

```
DSPMAILLOG PERIOD ( (*AVAIL *BEGIN) (*AVAIL *END) )  
                OUTPUT (*PRINT)
```

All available mail log entries in the current journal receiver chain are printed.

Display Page Data (DSPPAGDTA)

Where allowed to run: All environments (*ALL)

Threadsafe: No

The Display Page Data (DSPPAGDTA) command shows the contents of a spooled file's pages at specified locations. The contents can be shown, printed, or directed to database output file (OUTFILE).

Parameters

Keyword	Description	Choices	Notes
FILE	Spooled file name	<i>Name</i> , *LASTCRT	Required, Positional 1
PAGDTA	Page data	Values (up to 12 repetitions): <i>Element list</i>	Required, Positional 2
	Element 1: Line	1-255, *STRPAGGRP, *DOCIDXTAG, *DOCIDXPAG, *DOCIDXGRP, *STRPAGGRPP, *DOCIDXTAGP, *DOCIDXGRPP	
	Element 2: Position	1-378, 0	
	Element 3: Length	1-64, 0	
JOB	Job name	Single values: * Other values: <i>Qualified job name</i>	Optional, Positional 3
	Qualifier 1: Job name	<i>Name</i>	
	Qualifier 2: User	<i>Name</i>	
	Qualifier 3: Number	000000-999999	
SPLNBR	Spooled file number	1-999999, *ONLY, * LAST	Optional, Positional 4
OUTPUT	Output	*, *PRINT, *OUTFILE	Optional
OUTFILE	File to receive output	<i>Qualified object name</i>	Optional
	Qualifier 1: File to receive output	<i>Name</i>	
	Qualifier 2: Library	<i>Name</i> , *LIBL, *CURLIB	
OUTMBR	Output member options	<i>Element list</i>	Optional
	Element 1: Member to receive output	<i>Name</i> , * FIRST	
	Element 2: Replace or add records	* REPLACE , *ADD	

Spooled file name (FILE)

Specifies the name of the spooled file to process. CHAR(10)

This is a required parameter.

- *LASTCRT** The last spooled file created by the current job or thread is identified using the QSPRILSP API and processed. This is useful for jobs that create spooled files under other user profiles, which consequently end up in the user's QPRTJOB. When *LASTCRT is specified, the JOB() and SPLNBR() parameters are ignored.
- name*** Specify the name of the spooled file.

Page data (PAGDTA)

Specifies the location (line, position and length), on the page of the spooled file, from which data is retrieved. INT(2), INT(2), INT(2)

This is a required parameter.

Element 1: Line

- *STRPAGGRP** Data specified on the DDS STRPAGGRP() keyword is retrieved. These keywords inherit the page number of the next page to occur in the spooled file.
This value is only valid with *AFPDS spooled files. Position and length are ignored as data does not appear on the printed page and the length is derived from the value stored.
- *DOCIDXTAG** Data specified on the DDS DOCIDXTAG() keyword is retrieved. Tags specified at both the "page" level and "group" level are processed. "Group" level tags inherit the page number of the next page to occur in the spooled file.

This value is only valid with *AFPDS spooled files. Position and length are ignored as data does not appear on the printed page and the length is derived from the value stored.

***DOCIXPAG** Data specified on the DDS DOCIDXTAG() keyword is retrieved. Only tags specified at the "page" level are processed.

This value is only valid with *AFPDS spooled files. Position and length are ignored as data does not appear on the printed page and the length is derived from the value stored.

***DOCIXGRP** Data specified on the DDS DOCIDXTAG() keyword is retrieved. Only tags specified at the "group" level are processed. These tags inherit the page number of the next page to occur in the spooled file.

This value is only valid with *AFPDS spooled files. Position and length are ignored as data does not appear on the printed page and the length is derived from the value stored.

***STRPAGGRP** Data specified on the DDS STRPAGGRP() keyword is retrieved. These keywords inherit the page number of the next page to occur in the spooled file and are propagated to subsequent pages in the page group. Propagation processing gives the appearance that the keyword was specified directly on each subsequent page in the group.

This value is only valid with *AFPDS spooled files. Position and length are ignored as data does not appear on the printed page and the length is derived from the value stored.

***DOCIXTAGP** Data specified on the DDS DOCIDXTAG() keyword is retrieved. Tags specified at both the "page" level and "group" level are processed. "Group" level tags inherit the page number of the next page to occur in the spooled file and are propagated to subsequent pages in the page group. Propagation processing gives the appearance that the "group" level tag was specified directly on each subsequent page in the group.

This value is only valid with *AFPDS spooled files. Position and length are ignored as data does not appear on the printed page and the length is derived from the value stored.

***DOCIXGRP** Data specified on the DDS DOCIDXTAG() keyword is retrieved. Only tags specified at the "group" level are processed. These tags inherit the page number of the next page to occur in the spooled file and are propagated to subsequent pages in the page group. Propagation processing gives the appearance that the "group" level tag was specified directly on each subsequent page in the group.

This value is only valid with *AFPDS spooled files. Position and length are ignored as data does not appear on the printed page and the length is derived from the value stored.

1-255 Specify the line number where the data is located on the page.

Element 2: Position

1-378 Specify the position where the data is located in the line. Valid values range from 1 through 378. The value specified plus the data length should be less than the number of print positions in the spooled file.

Element 3: Length

1-64 Specify the length of the data. The value specified plus the start position should be less than the number of print positions in the spooled file.

Job name (JOB)

Specifies the job that contains the spooled file.

Single values

***** The job that issued the command.

Qualifier 1: Job name

name Specify the name of the job. CHAR(10)

Qualifier 2: User

name Specify the name that identifies the user profile under which the job is run. CHAR(10)

Qualifier 3: Number

000000-999999 Specify the system assigned job number. CHAR(6)

Spooled file number (SPLNBR)

Specifies the number of the spooled file. INT(4)

*LAST	The highest numbered spooled file with the specified file name is used.
*ONLY	The number of the only spooled file with the specified file name is used.
1-999999	Specify the number of the spooled file.

Output (OUTPUT)

Specifies where the output from the command is sent. CHAR(10)

*	The output is displayed (if requested by an interactive job) or printed with the job's spooled output (if requested by a batch job).
*PRINT	The output is printed with the job's spooled output.
*OUTFILE	The output is directed to the database file specified on the File to receive output prompt (OUTFILE parameter).

File to receive output (OUTFILE)

Specifies the name and library of the database file to which the output of the command is directed. If the file does not exist, the command creates one in the specified library. CHAR(10) CHAR(10)

Qualifier 1: File to receive output

name Specify the name of the file to which the output of the command is directed.

Qualifier 2: Library

*LIBL	All libraries in the thread's library list are searched.
*CURLIB	Use the current library for the job. If no library is specified as the current library for the job, QGPL is used.
name	Specify the name of the library.

Data is output in the PDPAGDRF record format which is documented in the appendix.

Output member options (OUTMBR)

Specifies the name of the database file member that receives the output of the command. CHAR(10) CHAR(10)

Element 1: Member to receive output

*FIRST	The first member in the file receives the output. If it does not exist, the system creates a member with the name of the file specified in the File to receive output prompt (OUTFILE parameter). If the member already exists, you have the option to add new records to the end of the existing member or clear the member and then add the new records.
name	Specify the name of the member that receives the output. If it does not exist, the system creates it.

Element 2: Replace or add records

*REPLACE	The system clears the existing member and adds the new records.
*ADD	The system adds the new records to the end of the existing records.

Examples

Example 1:

```
DSPPAGDTA FILE(QSYSPRT)
           PAGDTA((3 4 10) (*STRPAGGRP))
           JOB(033194/QPGMR/MONTHEND) SPLNBR(2)
```

This command displays data from line 3, position 4 for a length of 10 from each page in the spooled file as well as the page group names added using the STRPAGGRP() DDS keyword. The spooled file processed is file number 2, QSYSPRT, from job 033194/QPGMR/MONTHEND.

Example 2:

```
DSPPAGDTA FILE (INVOICE) PAGDTA ( (*DOCIDXTAG) )
          OUTPUT (*OUTFILE)
          OUTFILE (HISTORY/INVSPLF)
          OUTMBR (*FIRST *ADD)
```

This command retrieves data stored in DOCIDXTAG() DDS keywords for all pages of the spooled file INVOICE found in the current job. The data is added to the first member of the file INVSPLF found in library HISTORY.

Error messages**Parameter dependencies**

- GCM7014** OUTFILE parameter required with OUTPUT(*OUTFILE).
- GCM7015** OUTFILE parameter can only be specified with OUTPUT(*OUTFILE).
- GCM7016** OUTMBR parameter can only be specified with OUTPUT(*OUTFILE).

Display Report Log (DSPRPTLOG)

Where allowed to run: All environments (*ALL)

Threadsafe: No

The Display Report Log display shows entries from the report distribution log.

The report distribution log contains information about the work performed by report writers. The log contains entries for each spooled file processed, each delivery made, and any errors or warnings encountered.

Parameters

Keyword	Description	Choices	Notes
PERIOD	Time period	<i>Element list</i>	Optional, Positional 1
	Element 1: Starting time and date	<i>Element list</i>	
	Element 1: Starting time	<i>Time, *AVAIL</i>	
	Element 2: Starting date	<i>Date, *CURRENT, *BEGIN</i>	
	Element 2: Ending time and date	<i>Element list</i>	
	Element 1: Ending time	<i>Time, *AVAIL</i>	
	Element 2: Ending date	<i>Date, *CURRENT, *END</i>	
RPT	Report	Single values: <i>*ALL, *NONE</i> Other values: <i>Qualified object name</i>	Optional, Positional 2
	Qualifier 1: Report	<i>Name</i>	
	Qualifier 2: Library	<i>Name, *LIBL, *CURLIB</i>	
STATUS	Status	<i>*ALL, *CALLED, *CREATED, *DELIVERE, *ERROR, *HELD, *NEW, *OMITTED, *PRINTED, *QUEUED, *READY, *SENT, *STAGED, *VOIDED</i>	Optional, Positional 3
OUTPUT	Output	<i>*, *PRINT</i>	Optional, Positional 4

Time period (PERIOD)

Specifies the time period for which log entries are shown. The following values can be coded for this parameter, which contains two lists of two values each.

Element 1: Starting time and date

Element 1: Starting time One of the following specifies the starting time from which entries are shown. Entries logged before this time on the **Starting date** are not shown.

***AVAIL**

All data that is available for the specified date is shown.

time

Specify the start time from which data for the specified date is shown. The time is specified in 24-hour format and can be specified with or without a time separator:

- Without a time separator, specify a string of 4 or 6 digits (hhmm or hhmmss) where hh = hours, mm = minutes, and ss = seconds.
- With a time separator, specify a string of 5 or 8 digits where the time separator specified for your job is used to separate the hours, minutes, and seconds. If you enter this command from the command line, the string must be enclosed in apostrophes. If a time separator other than the separator specified for your job is used, this command will fail.

Element 2: Starting date One of the following specifies the starting date from which entries are shown. Entries logged before this date are not shown.

***CURRENT**

The current date is used.

***BEGIN**

The data from the beginning of the log is shown.

date

Specify the start date from which data is shown. The date must be specified in the job date format.

Element 2: Ending time and date

Element 1: Ending time One of the following specifies the ending time to which entries are shown. Entries logged after this time on the **Ending date** are not shown.

***AVAIL**

All data that is available for the specified date is shown.

time Specify the end time to which data for the specified date is shown. The time is specified in 24-hour format and can be specified with or without a time separator:

- Without a time separator, specify a string of 4 or 6 digits (hhmm or hhmmss) where hh = hours, mm = minutes, and ss = seconds.
- With a time separator, specify a string of 5 or 8 digits where the time separator specified for your job is used to separate the hours, minutes, and seconds. If you enter this command from the command line, the string must be enclosed in apostrophes. If a time separator other than the separator specified for your job is used, this command will fail.

Element 2: Ending date One of the following specifies the ending date to which entries are shown. Entries logged after this date are not shown.

***CURRENT** The current date is used.
***END** The data to the end of the log is shown.
date Specify the end date to which data is shown. The date must be specified in the job date format.

Report (RPT)

Specifies the name of the report and the library where it resides.

Single values

***ALL** All reports are selected.
***NONE** Specifies entries with no associated report name.

Qualifier 1: Report

name Specify the name of the report.

Qualifier 2: Library

***LIBL** All libraries in the thread's library list are searched.
***CURLIB** Use the current library for the job. If no library is specified as the current library for the job, QGPL is used.
name Specify the name of the library.

Status (STATUS)

Specifies the status of log entries selected for display. For the purposes of selection, all entries of type *MESSAGE are considered to have a status of *ERROR even though *MESSAGE entries do not have status and aren't all related to an error condition.

***ALL** All statuses are selected.
***CALLED** The program specified as the destination of the report subscription was called.
***CREATED** The spooled file has been converted and an object (PC file) has been created with the name specified in the TOOBJ() parameter.
***DELIVERED** The spooled file has been delivered to all destinations specified by the report. While the spooled file is on all required output queues, printing may not be complete.
***ERROR** An error was encountered during processing of this entry.
***HELD** The spooled file relating to this entry has been held by an operator or by a report writer. A report writer holds a spooled when it encounters a report that has been held. A held report is ineligible for processing and none of the actions it specifies are taken until a Release Report (RLSRPT) command is issued. After the report has been released, distribution processing can be initiated by releasing the spooled file. If the spooled file was held by an operator then processing is initiated by releasing the spooled file.
***NEW** The staging process is in progress for the spooled file. A report writer creates a report distribution log entry with a status of *NEW as it starts processing a spooled file, and before the staging of subscriptions.
***OMITTED** Delivery was omitted for the subscription because the filter selected zero pages and omit zero page delivery was specified.
***PRINTED** The entry was forwarded by a report writer to a printer writer for printing. The printer writer may still be processing the spooled file.
***QUEUED** The entry was forwarded by a report writer to an output queue.
***READY** The spooled file has been delivered and is ready for printing by the report writer.

*SENT	The spooled file was sent to the network user specified on the subscription.
*STAGED	The processing preliminary to delivery of report subscriptions has been completed for this entry.
*VOIDED	The entry was forwarded by a report writer to an output queue processed by a second report writer. The second report writer selected a different report name for the spooled file and voided the entry created by the first report writer.

Output (OUTPUT)

Specifies where the output from the command is sent. CHAR(10)

_	The output is displayed (if requested by an interactive job) or printed with the job's spooled output (if requested by a batch job).
*PRINT	The output is printed with the job's spooled output.

Examples

Example 1:

```
DSPRPTLOG
```

This command displays report distribution log entries for all reports. All available entries from today are displayed.

Example 2:

```
DSPRPTLOG PERIOD ( (*AVAIL *BEGIN) (*AVAIL *END) )
           RPT (REPORTS/INV310)
```

This command displays report distribution log entries for report INV310 from the library named REPORTS. All available log entries from the beginning through the end of the log are displayed.

Example 3:

```
DSPRPTLOG PERIOD ( (134500) (144500) )
```

This command displays all the report distribution log entries that occurred between 1:45:00 PM and 2:45:00 PM today.

Display Report Selection List (DSPRPTSLTL)

Where allowed to run: All environments (*ALL)

Threadsafe: No

The Display Report Selection List (DSPRPTSLTL) command creates a list of report selection parameters from a report library list. The list presents the information in the same order in which a report writer processes reports when matching them to spooled files. Use the list to verify or debug report selection parameters.

Parameters

Keyword	Description	Choices	Notes
RPTLIBL	Report library list	Single values: *ALL, *ALLUSR, *CURLIB, *CURRENT, *NONE Other values (up to 5 repetitions): <i>Name</i>	Required, Positional 1
OUTPUT	Output	<i>_</i> , *PRINT	Optional, Positional 2

Report library list (RPTLIBL)

Specifies the library list that is used by the report writer to locate reports.

A report library list is a list of library names used to locate reports. A report writer compares the attributes of a spooled file to the selection criteria contained in reports to determine how a spooled file should be distributed. The comparison is made with reports in the first library in the report library list. If no match is found, the report writer compares the attributes to reports in the second library in the library list. This process is continued until a match is found or the report library list is exhausted.

Within a library, reports are compared in order by their selection sequence. Reports that specify a lower sequence number are compared before reports that specify a higher sequence number.

Note: When *JOBID,*ALL,*ALLUSR or *CURRENT is specified for the report library list, all of the reports in the specified libraries are located and considered as one group for comparison. All reports in the libraries with selection sequence 1 will be considered before any report with selection sequence 2.

Single values

*ALL	All libraries in the system including QSYS are searched.
*ALLUSR	All non-system libraries on the machine are searched.
*CURLIB	Use the current library for the job. If no library is specified as the current library for the job, QGPL is used.
*CURRENT	The library list of the job that is running the command is used.
*NONE	The writer does not compare spooled files to reports to determine processing. All spooled files are delivered to the report writer's default destination queue. This value is useful for report writers that are intended to only produce separator pages and not to provide report distribution processing.

Other values (up to 5 repetitions)

<i>name</i>	Specify the names of one or libraries that are in the report library list. No more than 5 names can be specified; the libraries are searched in the same order as they are listed here.
-------------	---

Output (OUTPUT)

Specifies where the output from the command is sent. CHAR(10)

<i>_</i>	The output is displayed (if requested by an interactive job) or printed with the job's spooled output (if requested by a batch job).
*PRINT	The output is printed with the job's spooled output.

Examples

Example 1:

```
DSPRPTSLTL RPTLIBL (REPORTS)
```

This command displays a list of selection parameters taken from reports in library REPORTS. The list is ordered in the same way that a report writer orders the reports when processing spooled files.

Example 2:

```
DSRPTSLTL  RPTLIBL(REPORTS REPORTS2) OUTPUT(*PRINT)
```

This command prints a list of selection parameters taken from reports in libraries REPORTS and REPORTS2. The list is ordered in the same way that a report writer orders the reports when processing spooled files.

Duplicate Spooled File (DUPSPLF)

Where allowed to run: All environments (*ALL)

Threadsafe: No

The Duplicate Spooled File (DUPSPLF) command makes a duplicate copy of a spooled file.

Parameters

Keyword	Description	Choices	Notes
FILE	Spooled file name	<i>Name</i>	Required, Positional 1
TOOUTQ	To output queue	Single values: *SAME Other values: <i>Qualified object name</i>	Optional, Positional 2
	Qualifier 1: To output queue	<i>Name</i>	
	Qualifier 2: Library	<i>Name</i> , *LIBL , *CURLIB	
JOB	Job name	Single values: * Other values: <i>Qualified job name</i>	Optional, Positional 3
	Qualifier 1: Job name	<i>Name</i>	
	Qualifier 2: User	<i>Name</i>	
	Qualifier 3: Number	000000-999999	
SPLNBR	Spooled file number	1-999999, *ONLY , *LAST	Optional, Positional 4

Spooled file name (FILE)

Specifies the name of the spooled file to process. CHAR(10)

This is a required parameter.

name Specify the name of the spooled file.

To output queue (TOOUTQ)

Specifies the name of the output queue to receive the duplicate.

Single values

***SAME** The value is not changed.

Qualifier 1: Output queue

name Specify the name of the output queue.

Qualifier 2: Library

***LIBL** All libraries in the thread's library list are searched.

***CURLIB** Use the current library for the job. If no library is specified as the current library for the job, QGPL is used.

name Specify the name of the library.

Job name (JOB)

Specifies the job that contains the spooled file.

Single values

***** The job that issued the command.

Qualifier 1: Job name

name Specify the name of the job. CHAR(10)

Qualifier 2: User

name Specify the name that identifies the user profile under which the job is run. CHAR(10)

Qualifier 3: Number

000000-999999 Specify the system assigned job number. CHAR(6)

Spooled file number (SPLNBR)

Specifies the number of the spooled file. INT(4)

***LAST** The highest numbered spooled file with the specified file name is used.
***ONLY** The number of the only spooled file with the specified file name is used.
1-999999 Specify the number of the spooled file.

Examples

Example 1:

```
DUPSPLF FILE(QSYSPRT)
```

This command duplicates the last spooled file named QSYSPRT. The current job is searched to locate the file. The duplicate copy is placed on the same output queue as the original.

Example 2:

```
DUPSPLF FILE(QPQUPRFIL) TOOUTQ(PRT01) SPLNBR(3)
```

The file named QPQUPRFIL, which is spooled file number 3 in the job executing this command, is duplicated. The duplicate is placed on output queue PRT01.

End Report Writer (ENDRPTWTR)

Where allowed to run: All environments (*ALL)

Threadsafe: No

The End Report Writer (ENDRPTWTR) command ends a report writer.

Parameters

Keyword	Description	Choices	Notes
WTR	Writer	<i>Generic name, name, *ALL</i>	Required, Positional 1
OPTION	When to end report writer	*CNTRLD , *IMMED, *PAGEEND	Optional, Positional 2

Writer (WTR)

Specifies the name of the report writer.

This is a required parameter.

<i>generic-name</i>	Specify a generic name. Report writers whose names begin with the specified characters are selected.
<i>name</i>	Specify the name of the report writer.
*ALL	All report writers are selected.

When to end report writer (OPTION)

Specifies when the report writer should stop processing.

*CNTRLD	The report writer stops processing in a controlled manner. Printing stops at the end of the spooled file currently on the output device. Distribution processing stops at the end of the spooled file currently being processed.
*IMMED	The report writer stops printing immediately. The spooled file that is currently printing remains on the output device. Distribution processing stops at the end of the spooled file currently being processed.
*PAGEEND	The report writer stops printing at the end of a page. The spooled file that is currently printing remains on the output device. Distribution processing stops at the end of the spooled file currently being processed.

Examples

Example 1:

```
ENDRPTWTR WTR(QSYSPRT)
```

This command ends report writer QSYSPRT in a controlled manner.

Example 2:

```
ENDRPTWTR WTR(PRT01) OPTION(*IMMED)
```

This command ends report writer PRT01 immediately.

Extract Form Type (EXTRMTYP)

Where allowed to run: All environments (*ALL)

Threadsafe: No

The Extract Form Type (EXTRMTYP) command extracts form type names from existing printer files. For each form type found on the specified printer file(s), a Create Form Type (CRTRMTYP) command is issued with the physical copies parameter set to 1. The usefulness of the information extracted will vary from system to system and depends in part on the software construction techniques in use.

Parameters

Keyword	Description	Choices	Notes
PRTF	Printer file	<i>Qualified object name</i>	Required, Positional 1
	Qualifier 1: Printer file	<i>Generic name, name, *ALL</i>	
	Qualifier 2: Library	<i>Name, *LIBL, *CURLIB, *USRLIBL, *ALLUSR, *ALL</i>	

Printer file (PRTF)

Specifies the name of printer files from which form type information should be extracted.

This is a required parameter.

Qualifier 1: Printer file

- name*** Specify the name of the file. Form type information is extracted from this printer file only.
- generic-name*** Specify a generic name. Form type information is extracted from all printer files whose names begin with the specified characters.
- *ALL** Form type information is extracted from all printer files in the library or libraries.

Qualifier 2: Library

- *LIBL** All libraries in the thread's library list are searched.
- *CURLIB** Use the current library for the job. If no library is specified as the current library for the job, QGPL is used.
- *USRLIBL** Only the libraries in the user portion of the thread's library list are searched.
- *ALL** All libraries in the system including QSYS are searched.
- *ALLUSR** All non-system libraries on the machine are searched.
- name*** Specify the name of the library.

Examples

Example 1:

```
EXTRMTYP PRTF (INVENTORY/*ALL)
```

This command extracts the names of form types used in all printer device files found in library INVENTORY.

Example 2:

```
EXTRMTYP PRTF (*ALLUSR/*ALL)
```

This command extracts the names of form types used in all printer device files found in all user libraries on the system.

Extract Report (EXTRPT)

Where allowed to run: All environments (*ALL)
Threadsafe: No

The Extract Report (EXTRPT) command extracts reports from existing applications. The command is intended to assist in the implementation of Report Manager. It takes advantage of the fact that the vast majority of reports can be identified by the name of the program that creates them or by the name of the program and the name of the spooled file.

The Extract Report (EXTRPT) command analyzes the references of the specified program(s) to identify programs that are printing reports. A Create Report (CRTRPT) command with approximations for parameter values is issued for each report found. The accuracy of the reports created will vary from application to application and depends in part on the software construction techniques in use. For the best results, insure that libraries containing the files referenced by the specified program(s) are in your library list. Review the reports created by this command, correcting parameters as required.

Parameters

Keyword	Description	Choices	Notes
PGM	Program	<i>Qualified object name</i>	Required, Positional 1
	Qualifier 1: Program	<i>Generic name, name, *ALL</i>	
	Qualifier 2: Library	<i>Name, *LIBL, *CURLIB, *USRLIBL, *ALLUSR, *ALL</i>	
TOLIB	Library to receive reports	<i>Name, *CURLIB, *PGMLIB</i>	Optional, Positional 2

Program (PGM)

Specifies the name of programs from which reports should be extracted.

This is a required parameter.

Qualifier 1: Report

name Specify the name of the report.
generic-name Specify a generic name. Reports whose names begin with the specified characters are selected.
***ALL** All reports in the library or libraries are selected.

Qualifier 2: Library

***LIBL** All libraries in the thread's library list are searched.
***CURLIB** Use the current library for the job. If no library is specified as the current library for the job, QGPL is used.
***USRLIBL** Only the libraries in the user portion of the thread's library list are searched.
***ALL** All libraries in the system including QSYS are searched.
***ALLUSR** All non-system libraries on the machine are searched.
name Specify the name of the library.

Library to receive reports (TOLIB)

Specifies the name of the library in which reports are created.

***CURLIB** Use the current library for the job. If no library is specified as the current library for the job, QGPL is used.
***PGMLIB** Use the name of the library that contains the program.
name Specify the name of the library.

Examples

Example 1:

```
EXTRPT RPT(INVENTORY/*ALL) TOLIB(REPORTS)
```

This command analyzes all programs in library INVENTORY. For programs that create printed output, a report is created and placed in library REPORTS.

Example 2:

```
EXTRPT RPT(INV*) TOLIB(*PGMLIB)
```

This command analyzes all programs found in the thread's library list whose names begin with "INV". For programs that create printed output, a report is created and placed in the same library as the program.

Hold Report (HLDRPT)

Where allowed to run: All environments (*ALL)

Threadsafe: No

The Hold Report (HLDRPT) command places one or more reports on hold.

A held report is ineligible for processing by report writers. When a report writer encounters one of the report's spooled files the spooled file is held. None of the actions the report specifies are taken. None of the report's subscriptions are delivered. The report is held until a Release Report (RLSRPT) command is issued.

Note: Reports and report subscriptions can both be held. When a report is held, report writers hold the spooled file without further processing. When a report subscription is held, report writers skip the processing specified by that subscription only. All other processing is performed.

Parameters

Keyword	Description	Choices	Notes
RPT	Report	<i>Qualified object name</i>	Required, Positional 1
	Qualifier 1: Report	<i>Generic name, name, *ALL</i>	
	Qualifier 2: Library	<i>Name, *LIBL, *CURLIB, *USRLIBL, *ALLUSR, *ALL</i>	

Report (RPT)

Specifies the name of the report and the library where it resides.

This is a required parameter.

Qualifier 1: Report

- name*** Specify the name of the report.
- generic-name*** Specify a generic name. Reports whose names begin with the specified characters are selected.
- *ALL** All reports in the library or libraries are selected.

Qualifier 2: Library

- *LIBL** All libraries in the thread's library list are searched.
- *CURLIB** Use the current library for the job. If no library is specified as the current library for the job, QGPL is used.
- *USRLIBL** Only the libraries in the user portion of the thread's library list are searched.
- *ALL** All libraries in the system including QSYS are searched.
- *ALLUSR** All non-system libraries on the machine are searched.
- name*** Specify the name of the library.

Examples

Example 1:

```
HLDRPT RPT (REPORTS/INV320)
```

This command holds a report named INV320 in library REPORTS.

Example 2:

```
HLDRPT RPT (REPORTS/INV*)
```

This command holds all reports in library REPORTS whose names begin with "INV".

Example 3:

```
HLDRPT RPT (*ALL/INV*)
```

This command holds all reports whose names begin with "INV" from all libraries on the system.

Hold Report Subscription (HLDRPTSUB)

Where allowed to run: All environments (*ALL)

Threadsafe: No

The Hold Report Subscription (HLDRPTSUB) command places subscriptions from one or more reports on hold.

A held report subscription is ineligible for processing by a report writer. When a report writer processes a report, actions specified by held subscriptions are not taken.

Note: Reports and report subscriptions can both be held. When a report is held, report writers hold the spooled file without further processing. When a report subscription is held, report writers skip the processing specified by that subscription only. All other processing is performed.

Parameters

Keyword	Description	Choices	Notes
RPT	Report	<i>Qualified object name</i>	Required, Positional 1
	Qualifier 1: Report	<i>Generic name, name, *ALL</i>	
	Qualifier 2: Library	<i>Name, *LIBL, *CURLIB, *USRLIBL, *ALLUSR, *ALL</i>	
USER	User	<i>Name, *CURRENT, *CREATOR, *USRID, *CREATOR2, *ALL</i>	Optional, Positional 2
USRID	Network user	Single values: <i>*NONE, *ALL, *SPLFCRT, *SPLFOWN</i> Other values: <i>Element list</i>	Optional, Positional 3
	Element 1: User ID	<i>Character value</i>	
	Element 2: Address	<i>Character value</i>	
SUBNBR	Subscription number	1-255, <i>*ALL</i>	Optional, Positional 4

Report (RPT)

Specifies the name of the report and the library where it resides.

This is a required parameter.

Qualifier 1: Report

- name*** Specify the name of the report.
- generic-name*** Specify a generic name. Reports whose names begin with the specified characters are selected.
- *ALL** All reports in the library or libraries are selected.

Qualifier 2: Library

- *LIBL** All libraries in the thread's library list are searched.
- *CURLIB** Use the current library for the job. If no library is specified as the current library for the job, QGPL is used.
- *USRLIBL** Only the libraries in the user portion of the thread's library list are searched.
- *ALL** All libraries in the system including QSYS are searched.
- *ALLUSR** All non-system libraries on the machine are searched.
- name*** Specify the name of the library.

User (USER)

Specifies the user who is subscribed to the report.

- *CURRENT** The subscription is for the user of the current job.
- *CREATOR** The subscription is for the user creating the spooled file. Report writers resolve this value using the user portion of the qualified job name that contains the spooled file.
- *CREATOR2** The subscription is for the user creating the spooled file. Report writers resolve this value using information in the spooled file's attributes. Use this value if the spooled file was originally created on another system.
- *USRID** The subscription is for the network user identified by the **USRID** parameter.
- *ALL** Specifies the subscriptions for every user.

name Specify the name of the user profile.

Network user (USRID)

Specifies the network user who is subscribed to the report. A network user receives subscriptions on the local system or on a remote system as email or through the SNADS network. For email, subscriptions are delivered as a message with the spooled file placed in an attached file. For SNADS networks, subscriptions are placed on the output queue specified in the user profile of the network user. Network users are identified by a two part user ID or by a two part distribution list ID.

A network user receives subscriptions on the local system or on a remote system as email or through the SNADS network. For email, subscriptions are delivered as a message with the spooled file placed in an attached file. For SNADS networks, subscriptions are placed on the output queue specified in the user profile of the network user. Network users are identified by a two part user ID or by a two part distribution list ID.

Single values

- *NONE** The subscription is not for a network user.
- *ALL** Specifies the subscriptions for every network user.
- *SPLFCRT** The subscription is for the user creating the spooled file. Report writers resolve this value using information in the spooled file's attributes. Use this value if the spooled file was originally created on another system. The directory entry for the user profile is retrieved to determine the target User ID and Address.
- *SPLFOWN** The subscription is for the user owning the spooled file. Report writers resolve this value using the user portion of the qualified job name that contains the spooled file. The directory entry for the user profile is retrieved to determine the target User ID and Address.

Element 1: User ID

character-value Specify the user ID (DEN) of the network user. CHAR(8)

Element 2: Address

character-value Specify the address (DGN) of the network user. CHAR(8)

Subscription number (SUBNBR)

Specifies the subscription number. Subscription numbers uniquely identify the subscriptions of an individual subscriber to a report. This allows a user or network user to subscribe to a report more than once.

Subscription numbers uniquely identify the subscriptions of an individual subscriber to a report. Subscription numbers allow a subscriber to subscribe to a report more than once.

- *ALL** Specifies all subscriptions for the subscriber.
- 1-255** Specify a subscription number.

Examples

Example 1:

```
HLD RPTSUB RPT (REPORTS/INV310) SUBNBR (1)
```

This command holds subscription number 1 to report INV310 for the user issuing the command. The report containing the subscription is located in library REPORTS.

Example 2:

```
HLD RPTSUB RPT (INVENTORY/*ALL) USER (QPGMR)
```

This command holds all of QPGMR's subscriptions to all reports in library INVENTORY. If QPGMR has subscriptions to reports located in other libraries, they remain unchanged.

Example 3:

```
HLD RPTSUB RPT (*ALL/MKRPT*) USER (*USRID) USRID (BSMITH SEATTLE)
```

This command holds subscriptions for network user BSMITH at SEATTLE from all reports whose names begin with "MKRPT". All libraries on the system are searched.

Error messages

Parameter dependencies

RDM7006	When user *USRID is specified a network user must be specified.
RDM7012	A network user or a user can be specified, but not both.
RDM7007	When network user *NONE is specified user *USRID cannot be specified.
RDM7005	When user *ALL is specified a specific network user cannot be specified.
RDM7004	When network user *ALL is specified user *USRID or user *ALL must also be specified.
RDM7003	Subscription number *ALL must be specified when user *ALL or network user *ALL is specified.

Hold Report Writer (HLDRPTWTR)

Where allowed to run: All environments (*ALL)

Threadsafe: No

The Hold Report Writer (HLDRPTWTR) command stops a report writer's processing. The report writer remains inactive until a Release Report Writer (RLSRPTWTR) or End Report Writer (ENDRPTWTR) command is issued.

Parameters

Keyword	Description	Choices	Notes
WTR	Writer	<i>Generic name, name, *ALL</i>	Required, Positional 1
OPTION	When to hold report writer	*IMMED , *CNTRLD, *PAGEEND	Optional, Positional 2

Writer (WTR)

Specifies the name of the report writer.

This is a required parameter.

<i>name</i>	Specify the name of the report writer.
<i>generic-name</i>	Specify a generic name. Report writers whose names begin with the specified characters are selected.
*ALL	All report writers are selected.

When to hold report writer (OPTION)

Specifies when the report writer should stop processing.

*IMMED	The report writer stops printing immediately after it has printed the last record in the current block of records. The spooled file that is currently printing remains on the output device. Distribution processing stops after printing has stopped.
*CNTRLD	The report writer stops processing in a controlled manner. Printing stops at the end of the spooled file currently on the output device. Distribution processing stops after printing stops.
*PAGEEND	The report writer stops printing at the end of a page. The spooled file that is currently printing remains on the output device. Distribution processing stops when printing stops.

Examples

Example 1:

```
HLDRPTWTR WTR(QSYSPRT)
```

This command holds report writer QSYSPRT in a controlled manner.

Example 2:

```
HLDRPTWTR WTR(PRT01) OPTION(*IMMED)
```

This command holds report writer PRT01 immediately.

Restart/Purge Local Mail (INZLOCAL)

Where allowed to run: All environments (*ALL)

Threadsafe: No

The Restart/Purge Local Mail (INZLOCAL) command ends and restarts IBM i mail components. This may be required to clear problems or to make configuration changes immediately effective.

Parameters

Keyword	Description	Choices	Notes
SMTP	Restart SMTP server	<u>*YES</u> , *NO, Y, N	Optional, Positional 1
SMTPPURGE	Clear SMTP during restart	<u>*NO</u> , *YES, Y, N	Optional, Positional 2
MSF	Restart MSF server	<u>*YES</u> , *NO, Y, N	Optional, Positional 3
MSFPURGE	Clear MSF during restart	<u>*NO</u> , *YES, Y, N	Optional, Positional 4

Restart SMTP server (SMTP)

Specifies the whether the SMTP server is restarted.

- *YES The SMTP server is first ended then started.
- *NO The command does not restart the SMTP server.

Clear SMTP during restart (SMTPPURGE)

Specifies the whether the SMTP server is purged during the restart.

Note: Clear means that all IBM i SMTP email will be deleted. If you are not sure, select *NO.

- *NO Existing messages are not cleared.
- *YES Existing messages are cleared.

Restart MSF server (MSF)

Specifies the whether the MSF server is restarted.

- *YES The MSF server is first ended then started.
- *NO The command does not restart the MSF server.

Clear MSF during restart (MSFPURGE)

Specifies the whether the MSF server is cleared during the restart.

Note: Clear means that mail server framework distributions (emails) will be deleted from this system. If you are not sure, select *NO.

- *NO The MSF is not cleared.
- *YES The MSF is cleared.

Examples

Example 1:

```
INZLOCAL
```

This command restarts the SMTP server and Mail Server Framework jobs.

Example 2:

```
INZLOCAL      SMTPPURGE (*YES) MSFPURGE (*YES)
```

This command restarts the SMTP server and Mail Server Framework jobs after purging all data they contain.

Error messages**Parameter dependencies**

MSU7012	SMTP cannot be cleared unless it is also restarted.
MSU7013	MSF cannot be cleared unless it is also restarted.

Merge Spooled File (MRGSPLF)

Where allowed to run: All environments (*ALL)

Threadsafe: No

The Merge Spooled File (MRGSPLF) command combines the pages of one or more spooled files to create a new spooled file and optionally sorts the pages.

Parameters

Keyword	Description	Choices	Notes
MRGFILE	Merge input list	Values (up to 128 repetitions): <i>Element list</i>	Required, Positional 1
	Element 1: Spooled file name	<i>Name</i>	
	Element 2: Job name	Single values: * Other values: <i>Qualified job name</i>	
	Qualifier 1: Job name	<i>Name</i>	
	Qualifier 2: User	<i>Name</i>	
	Qualifier 3: Number	000000-999999	
	Element 3: Spooled file number	1-999999, * LAST , * ONLY	
	Element 4: Page sort key	Single values: * NONE , *STRPAGGRP Other values: <i>Element list</i>	
	Element 1: Line	1-255	
	Element 2: Position	1-378	
	Element 3: Length	1-64	
	Element 5: Page range to print	<i>Element list</i>	
	Element 1: Starting page	<i>Integer</i> , 1 , *ENDPAGE	
Element 2: Ending page	<i>Integer</i> , * END		
TOFILE	To spooled file name	<i>Name</i> , * FIRST	Optional, Positional 2
TOOUTQ	To output queue	Single values: * FIRST Other values: <i>Qualified object name</i>	Optional, Positional 3
	Qualifier 1: To output queue	<i>Name</i>	
	Qualifier 2: Library	<i>Name</i> , * LIBL , *CURLIB	
SPLIT	Generate multiple files	* NO , * YES	Optional, Positional 4

Merge input list (MRGFILE)

Specifies an input list to the merge. Each input is made up of 5 elements, a spooled file specification (the first three elements), its page sort key (the fourth element) and page range specification (the fifth element). The spooled file specified participates in the merge. Each page within the page range is sorted with other pages from the same spooled file and with pages from the other spooled files participating in the merge before the merged (output) spooled file is created.

Note: The first spooled file specified supplies the attributes for the spooled file that is created.

Element 1: Spooled file name

name Specify the name of the spooled file.

Element 2: Job name

Single values * The job that issued the command.
Qualifier 1: Job name **name** Specify the name of the job. CHAR(10)
Qualifier 2: User **name** Specify the name that identifies the user profile under which the job is run. CHAR(10)
Qualifier 3: Number **000000-999999** Specify the system assigned job number. CHAR(6)

Element 3: Spooled file number

***LAST** The highest numbered spooled file with the specified file name is used.
***ONLY** The number of the only spooled file with the specified file name is used.

1-999999 Specify the number of the spooled file.

Element 4: Page sort key

Single values	*NONE	No page sorting is performed.
	*STRPAGGRP	Pages are sorted based on the name of the page group to which they belong. For *AFPDS spooled files page groups can be created and named using the DDS STRPAGGRP and ENDPAGGRP keywords.
Element 1: Line	1-255	Specify the line number containing the data by which the page is sorted.
Element 2: Position	1-378	Specify the start position within line of the data by which the page is sorted. The value specified plus the length of the data should be less than the number of print positions in the spooled file.
Element 3: Length	1-64	Specify the length of the data by which the page is sorted. The value specified plus the start position should be less than the number of print positions in the spooled file.

Element 5: Page range to print

Element 1: Starting page	<u>1</u>	Processing begins at page 1.
	*ENDPAGE	The starting page to print is the ending page to print. Only the ending page is printed.
	integer	Specify the starting page.
Element 2: Ending page	*END	Processing continues until the end of file.
	integer	Specify the ending page.

To spooled file name (TOFILE)

Specifies the name of the merged (output) spooled file.

*FIRST	The name of the spooled file is that of the first spooled file.
name	Specify the name of the spooled file.

To output queue (TOOUTQ)

Specifies the name of the output queue to receive the merged (output) spooled file.

Single values

*FIRST	The output queue name is that of the first spooled file.
---------------	--

Qualifier 1: Output queue

name	Specify the name of the output queue.
-------------	---------------------------------------

Qualifier 2: Library

*LIBL	All libraries in the thread's library list are searched.
*CURLIB	Use the current library for the job. If no library is specified as the current library for the job, QGPL is used.
name	Specify the name of the library.

Generate multiple files (SPLIT)

Specifies whether or not a new spooled file is created each time the Page sort key changes.

*NO	The combined output of the merge is placed in a single spooled file.
*YES	For each unique value found in the Page sort key a new spooled file is created.

Examples

Example 1:

```
MRGSPLF MRGFILE ( (QSYSVRT) ) TOFILE (NEWFILE) TOOUTQ (PRT01)
```

The last spooled file from the current job with the name QSYSPRT is simply duplicated. The new duplicate is given the name NEWFILE and placed in output queue PRT01.

Example 2:

```
MRGSPLF MRGFILE((QSYSPRT) (QPRINT))
```

This command combines the contents of the last spooled file named QSYSPRT followed by the contents of the last spooled file named QPRINT with no sorting of pages. The current job is searched to locate the files. The new spooled file has the same attributes as QSYSPRT and is placed on the same output queue.

Example 3:

```
MRGSPLF MRGFILE((QPQUPRFL * 3 (2 3 8))  
                (QPRINT * 4 (1 120 6))) SPLIT(*YES)
```

The file named QPQUPRFL, which is spooled file number 3 in the job executing this command, is merged with the file named QPRINT, which is spooled file number 4 in the job executing the command. The combined set of pages is sorted based on the 8 characters found at line 2 position 3 of each page in QPQUPRFL and on the 6 characters found at line 1 position 120 of each page in QPRINT. Each time the data at these positions changes, a new spooled file is created.

Ping SMTP Mail Server (PINGMAIL)

Where allowed to run: All environments (*ALL)

Threadsafe: No

The Ping SMTP Mail Server (PINGMAIL) command establishes an SMTP connection with a remote system to insure it will process email from the local System i.

The detailed send and receive data from the connection is recorded in the joblog and can be view using the Display Job Log (DSPJOBLOG) command.

Parameters

Keyword	Description	Choices	Notes
RMTSYS	Remote system	Character value, *INTNETADR	Required, Positional 1
SMTPNAME	To SMTP name (email address)	Character value, *NONE	Optional
SMTPNAME2	From SMTP name (email address)	Character value, *SMTPNAME	Optional
AUTHUSRNAM	Authentication username	Character value, *NONE	Optional
AUTHPWD	Authentication password	Character value	Optional
PORT	Port	0-65534, 25	Optional
INTNETADR	Remote internet address	Character value	Optional

Remote system (RMTSYS)

Specifies the remote system name of the host with which the Ping SMTP Mail Server operation takes place. To be successful, the name must be valid, and the remote system must be able to communicate with the local system.

This is a required parameter.

***INTNETADR** The INTNETADR parameter is used.
character-value Specify the remote system name to use.

To SMTP name (email address) (SMTPNAME)

Specifies an email address to verify with the remote host. A short email message is sent to the address. The message is inserted directly into the mail server under test, bypassing all of IBM i's mail machinery. This makes it is easier to determine if a mail delivery problem is most likely caused by the mail server or by IBM i's configuration.

***NONE** An email address is not specified.
character-value Specify the email address to use.

From SMTP name (email address) (SMTPNAME2)

Specifies the from email address included in the test message.

***SMTPNAME** The To SMTP name (email address) is used as the From SMTP name (email address).
character-value Specify the email address to use.

Authentication username (AUTHUSRNAM)

Specifies the user name used to authenticate with the remote system.

***NONE** Authentication is not performed.
character-value Specify the user name to send to the remote system for authentication.

Authentication password (AUTHPWD)

Specifies the password used to authenticate with the remote system.

character-value Specify the password to send to the remote system for authentication.

Port (PORT)

Specifies the port on which the remote system is listening.

25 Use the well-known port 25 for SMTP.

integer Specify any port in the range of 1 to 65534 on which the remote system is listening for SMTP connections.

Remote internet address (INTNETADR)

Specifies the remote internet address. The internet address is specified in the form **nnn.nnn.nnn.nnn**, where **nnn** is a decimal number ranging from 0 through 255. An internet address is not valid if it has a value of all binary ones or all binary zeros for the network identifier (ID) portion or the host ID portion of the address. If the internet address is entered from a command line, enclose the address in apostrophes.

character-value Specify the internet address of the remote system. If the internet address is entered from a command line, enclose the address in apostrophes.

Examples

Example 1:

```
PINGMAIL RMTSYS(system2.widget.com)
```

This command tests system2 in the widget.com domain to insure that it will process email.

Example 2:

```
PINGMAIL RMTSYS(*INTNETADR INTNETADR('168.243.199.2'))
```

This command tests the system at IP address 168.243.199.2 to insure that it will process email.

Error messages

Parameter dependencies

MSU7009 When *INTNETADR is specified Remote internet address must be specified.

MSU7010 RMTSYS(*INTNETADR) required when INTNETADR is specified.

Release Report (RLSRPT)

Where allowed to run: All environments (*ALL)

Threadsafe: No

The Release Report (RLSRPT) command releases one or more previously held reports.

A held report is ineligible for processing by report writers. When a report writer encounters one of the report's spooled files the spooled file is held. None of the actions the report specifies are taken. None of the report's subscriptions are delivered. The report is held until a Release Report (RLSRPT) command is issued.

Parameters

Keyword	Description	Choices	Notes
RPT	Report	<i>Qualified object name</i>	Required, Positional 1
	Qualifier 1: Report	<i>Generic name, name, *ALL</i>	
	Qualifier 2: Library	<i>Name, *LIBL, *CURLIB, *USRLIBL, *ALLUSR, *ALL</i>	

Report (RPT)

Specifies the name of the report and the library where it resides.

This is a required parameter.

Qualifier 1: Report

- name*** Specify the name of the report.
- generic-name*** Specify a generic name. Reports whose names begin with the specified characters are selected.
- *ALL** All reports in the library or libraries are selected.

Qualifier 2: Library

- *LIBL** All libraries in the thread's library list are searched.
- *CURLIB** Use the current library for the job. If no library is specified as the current library for the job, QGPL is used.
- *USRLIBL** Only the libraries in the user portion of the thread's library list are searched.
- *ALL** All libraries in the system including QSYS are searched.
- *ALLUSR** All non-system libraries on the machine are searched.
- name*** Specify the name of the library.

Examples

Example 1:

```
RLSRPT RPT (REPORTS/INV320)
```

This command releases a report named INV320 in library REPORTS.

Example 2:

```
RLSRPT RPT (REPORTS/INV*)
```

This command releases all reports in library REPORTS whose names begin with "INV".

Example 3:

```
RLSRPT RPT (*ALL/INV*)
```

This command releases all reports whose names begin with "INV" from all libraries on the system.

Release Report Subscription (RLSRPTSUB)

Where allowed to run: All environments (*ALL)

Threadsafe: No

The Release Report Subscription (RLSRPTSUB) command releases previously held subscriptions in one or more reports.

A held report subscription is ineligible for processing by a report writer. When a report writer processes a report, actions specified by held subscriptions are not taken.

Parameters

Keyword	Description	Choices	Notes
RPT	Report	<i>Qualified object name</i>	Required, Positional 1
	Qualifier 1: Report	<i>Generic name, name, *ALL</i>	
	Qualifier 2: Library	<i>Name, *LIBL, *CURLIB, *USRLIBL, *ALLUSR, *ALL</i>	
USER	User	<i>Name, *CURRENT, *CREATOR, *USRID, *CREATOR2, *ALL</i>	Optional, Positional 2
USRID	Network user	Single values: <i>*NONE, *ALL, *SPLFCRT, *SPLFOWN</i> Other values: <i>Element list</i>	Optional, Positional 3
	Element 1: User ID	<i>Character value</i>	
	Element 2: Address	<i>Character value</i>	
SUBNBR	Subscription number	1-255, <i>*ALL</i>	Optional, Positional 4

Report (RPT)

Specifies the name of the report and the library where it resides.

This is a required parameter.

Qualifier 1: Report

- name*** Specify the name of the report.
- generic-name*** Specify a generic name. Reports whose names begin with the specified characters are selected.
- *ALL** All reports in the library or libraries are selected.

Qualifier 2: Library

- *LIBL** All libraries in the thread's library list are searched.
- *CURLIB** Use the current library for the job. If no library is specified as the current library for the job, QGPL is used.
- *USRLIBL** Only the libraries in the user portion of the thread's library list are searched.
- *ALL** All libraries in the system including QSYS are searched.
- *ALLUSR** All non-system libraries on the machine are searched.
- name*** Specify the name of the library.

User (USER)

Specifies the user who is subscribed to the report.

- *CURRENT** The subscription is for the user of the current job.
- *CREATOR** The subscription is for the user creating the spooled file. Report writers resolve this value using the user portion of the qualified job name that contains the spooled file.
- *CREATOR2** The subscription is for the user creating the spooled file. Report writers resolve this value using information in the spooled file's attributes. Use this value if the spooled file was originally created on another system.
- *USRID** The subscription is for the network user identified by the **USRID** parameter.
- *ALL** Specifies the subscriptions for every user.
- name*** Specify the name of the user profile.

Network user (USRID)

Specifies the network user who is subscribed to the report. A network user receives subscriptions on the local system or on a remote system as email or through the SNADS network. For email, subscriptions are delivered as a message with the spooled file placed in an attached file. For SNADS networks, subscriptions are placed on the output queue specified in the user profile of the network user. Network users are identified by a two part user ID or by a two part distribution list ID.

A network user receives subscriptions on the local system or on a remote system as email or through the SNADS network. For email, subscriptions are delivered as a message with the spooled file placed in an attached file. For SNADS networks, subscriptions are placed on the output queue specified in the user profile of the network user. Network users are identified by a two part user ID or by a two part distribution list ID.

Single values

*NONE	The subscription is not for a network user.
*ALL	Specifies the subscriptions for every network user.
*SPLFCRT	The subscription is for the user creating the spooled file. Report writers resolve this value using information in the spooled file's attributes. Use this value if the spooled file was originally created on another system. The directory entry for the user profile is retrieved to determine the target User ID and Address.
*SPLFOWN	The subscription is for the user owning the spooled file. Report writers resolve this value using the user portion of the qualified job name that contains the spooled file. The directory entry for the user profile is retrieved to determine the target User ID and Address.

Element 1: User ID

character-value Specify the user ID (DEN) of the network user. CHAR(8)

Element 2: Address

character-value Specify the address (DGN) of the network user. CHAR(8)

Subscription number (SUBNBR)

Specifies the subscription number. Subscription numbers uniquely identify the subscriptions of an individual subscriber to a report. This allows a user or network user to subscribe to a report more than once.

Subscription numbers uniquely identify the subscriptions of an individual subscriber to a report. Subscription numbers allow a subscriber to subscribe to a report more than once.

*ALL	Specifies all subscriptions for the subscriber.
1-255	Specify a subscription number.

Examples

Example 1:

```
RLSRPTSUB RPT (REPORTS/INV310) SUBNBR (1)
```

This command releases subscription number 1 to report INV310 for the user issuing the command. The report containing the subscription is located in library REPORTS.

Example 2:

```
RLSRPTSUB RPT (INVENTORY/*ALL) USER (QPGMR)
```

This command releases all of QPGMR's subscriptions to all reports in library INVENTORY. If QPGMR has subscriptions to reports located in other libraries, they remain unchanged.

Example 3:

```
RLSRPTSUB RPT (*ALL/MKRPT*) USER (*USRID) USRID (BSMITH SEATTLE)
```

This command releases subscriptions for network user BSMITH at SEATTLE in all reports whose names begin with MKRPT. All libraries on the system are searched.

Error messages

Parameter dependencies

RDM7006	When user *USRID is specified a network user must be specified.
RDM7012	A network user or a user can be specified, but not both.
RDM7007	When network user *NONE is specified user *USRID cannot be specified.
RDM7005	When user *ALL is specified a specific network user cannot be specified.
RDM7004	When network user *ALL is specified user *USRID or user *ALL must also be specified.
RDM7003	Subscription number *ALL must be specified when user *ALL or network user *ALL is specified.

Release Report Writer (RLSRPTWTR)

Where allowed to run: All environments (*ALL)

Threadsafe: No

The Release Report Writer (RLSRPTWTR) command releases a held report writer so that files on the output queue can be processed. If the writer was printing a file when it was held, the writer resumes printing this same file.

Parameters

Keyword	Description	Choices	Notes
WTR	Writer	<i>Generic name, name, *ALL</i>	Required, Positional 1

Writer (WTR)

Specifies the name of the report writer.

This is a required parameter.

<i>generic-name</i>	Specify a generic name. Report writers whose names begin with the specified characters are selected.
<i>name</i>	Specify the name of the report writer.
*ALL	All report writers are selected.

Examples

Example 1:

```
RLSRPTWTR WTR(QSYSPRT)
```

This command releases report writer QSYSPRT.

Example 2:

```
RLSRPTWTR WTR(PRT01)
```

This command releases report writer PRT01.

Remove Report Filter (RMVRPTFTR)

Where allowed to run: All environments (*ALL)

Threadsafe: No

The Remove Report Filter (RMVRPTFTR) command removes one or more filters from one or more reports. A filter is removed only if it is not referenced by a subscription.

A report filter specifies test criteria for a report that are used to reduce the number of pages delivered for a subscription. After a filter has been added to a report, it may be specified on one or more subscriptions. When a report writer processes the subscription, it tests each page of the spooled file against the filter criteria to determine if the page is selected for distribution. A page is selected when the data on the page meets the criteria specified.

All selected pages are placed in a new spooled file. If the user data (USRDTA) attribute of the original spooled file is blank, the new spooled file has the filter's name for user data.

Parameters

Keyword	Description	Choices	Notes
RPT	Report	<i>Qualified object name</i>	Required, Positional 1
	Qualifier 1: Report	<i>Generic name, name, *ALL</i>	
	Qualifier 2: Library	<i>Name, *LIBL, *CURLIB, *USRLIBL, *ALLUSR, *ALL</i>	
RPTFTR	Report filter	<i>Generic name, name, *ALL</i>	Required, Positional 2

Report (RPT)

Specifies the name of the report and the library where it resides.

This is a required parameter.

Qualifier 1: Report

- name*** Specify the name of the report.
- generic-name*** Specify a generic name. Reports whose names begin with the specified characters are selected.
- *ALL** All reports in the library or libraries are selected.

Qualifier 2: Library

- *LIBL** All libraries in the thread's library list are searched.
- *CURLIB** Use the current library for the job. If no library is specified as the current library for the job, QGPL is used.
- *USRLIBL** Only the libraries in the user portion of the thread's library list are searched.
- *ALL** All libraries in the system including QSYS are searched.
- *ALLUSR** All non-system libraries on the machine are searched.
- name*** Specify the name of the library.

Report filter (RPTFTR)

Specifies the name of the report filter. Filter names are unique within a report.

This is a required parameter.

- name*** Specify the name of the filter.
- generic-name*** Specify a generic name. Filters whose names begin with the specified characters are selected.
- *ALL** All filters in the report are selected.

Examples

Example 1:

```
RMVRPTFTR RPTFTR(WESTERNREG) RPT(SOE112)
```

This command removes a filter named WESTERNREG from the report named SOE112. The report is located using the thread's library list. Before the filter is removed, subscriptions to the report are checked to insure that the filter is not referenced.

Example 2:

```
RMVRPTFTR RPTFTR(TOTALS*) RPT(INVENTORY/*ALL)
```

This command removes all filters with names that begin with "TOTALS" from every report found in the INVENTORY library.

Remove Report Subscription (RMVRPTSUB)

Where allowed to run: All environments (*ALL)

Threadsafe: No

The Remove Report Subscription (RMVRPTSUB) command removes subscriptions from one or more reports.

Parameters

Keyword	Description	Choices	Notes
RPT	Report	<i>Qualified object name</i>	Required,
	Qualifier 1: Report	<i>Generic name, name, *ALL</i>	Positional 1
	Qualifier 2: Library	<i>Name, *LIBL, *CURLIB, *USRLIBL, *ALLUSR, *ALL</i>	
USER	User	<i>Name, *CURRENT, *CREATOR, *USRID, *CREATOR2, *ALL</i>	Optional, Positional 2
USRID	Network user	Single values: <i>*NONE, *ALL, *SPLFCRT, *SPLFOWN</i> Other values: <i>Element list</i>	Optional, Positional 3
	Element 1: User ID	<i>Character value</i>	
	Element 2: Address	<i>Character value</i>	
SUBNBR	Subscription number	1-255, <i>*ALL</i>	Optional, Positional 4

Report (RPT)

Specifies the name of the report and the library where it resides.

This is a required parameter.

Qualifier 1: Report

- name*** Specify the name of the report.
- generic-name*** Specify a generic name. Reports whose names begin with the specified characters are selected.
- *ALL** All reports in the library or libraries are selected.

Qualifier 2: Library

- *LIBL** All libraries in the thread's library list are searched.
- *CURLIB** Use the current library for the job. If no library is specified as the current library for the job, QGPL is used.
- *USRLIBL** Only the libraries in the user portion of the thread's library list are searched.
- *ALL** All libraries in the system including QSYS are searched.
- *ALLUSR** All non-system libraries on the machine are searched.
- name*** Specify the name of the library.

User (USER)

Specifies the user who is subscribed to the report.

- *CURRENT** The subscription is for the user of the current job.
- *CREATOR** The subscription is for the user creating the spooled file. Report writers resolve this value using the user portion of the qualified job name that contains the spooled file.
- *CREATOR2** The subscription is for the user creating the spooled file. Report writers resolve this value using information in the spooled file's attributes. Use this value if the spooled file was originally created on another system.
- *USRID** The subscription is for the network user identified by the **USRID** parameter.
- *ALL** Specifies the subscriptions for every user.
- name*** Specify the name of the user profile.

Network user (USRID)

Specifies the network user who is subscribed to the report. A network user receives subscriptions on the local system or on a remote system as email or through the SNADS network. For email, subscriptions are delivered as a

message with the spooled file placed in an attached file. For SNADS networks, subscriptions are placed on the output queue specified in the user profile of the network user. Network users are identified by a two part user ID or by a two part distribution list ID.

A network user receives subscriptions on the local system or on a remote system as email or through the SNADS network. For email, subscriptions are delivered as a message with the spooled file placed in an attached file. For SNADS networks, subscriptions are placed on the output queue specified in the user profile of the network user. Network users are identified by a two part user ID or by a two part distribution list ID.

Single values

*NONE	The subscription is not for a network user.
*ALL	Specifies the subscriptions for every network user.
*SPLFCRT	The subscription is for the user creating the spooled file. Report writers resolve this value using information in the spooled file's attributes. Use this value if the spooled file was originally created on another system. The directory entry for the user profile is retrieved to determine the target User ID and Address.
*SPLFOWN	The subscription is for the user owning the spooled file. Report writers resolve this value using the user portion of the qualified job name that contains the spooled file. The directory entry for the user profile is retrieved to determine the target User ID and Address.

Element 1: User ID

character-value Specify the user ID (DEN) of the network user. CHAR(8)

Element 2: Address

character-value Specify the address (DGN) of the network user. CHAR(8)

Subscription number (SUBNBR)

Specifies the subscription number. Subscription numbers uniquely identify the subscriptions of an individual subscriber to a report. This allows a user or network user to subscribe to a report more than once.

Subscription numbers uniquely identify the subscriptions of an individual subscriber to a report. Subscription numbers allow a subscriber to subscribe to a report more than once.

*ALL	Specifies all subscriptions for the subscriber.
1-255	Specify a subscription number.

Examples

Example 1:

```
RMVRPTSUB RPT (REPORTS/INV310) SUBNBR (1)
```

This command removes subscription number 1 to report INV310 for the user issuing the command. The report containing the subscription is located in library REPORTS.

Example 2:

```
RMVRPTSUB RPT (INVENTORY/*ALL) USER (QPGMR)
```

This command removes all of QPGMR's subscriptions to all reports in library INVENTORY. If QPGMR has subscriptions to reports located in other libraries, they remain unchanged.

Example 3:

```
RMVRPTSUB RPT (*ALL/MKRPT*) USER (*USRID) USRID (BSMITH SEATTLE)
```

This command removes subscriptions for network user BSMITH at SEATTLE from all reports whose names begin with "MKRPT". All libraries on the system are searched.

Error messages

Parameter dependencies

RDM7006	When user *USRID is specified a network user must be specified.
RDM7012	A network user or a user can be specified, but not both.
RDM7007	When network user *NONE is specified user *USRID cannot be specified.
RDM7005	When user *ALL is specified a specific network user cannot be specified.
RDM7004	When network user *ALL is specified user *USRID or user *ALL must also be specified.
RDM7003	Subscription number *ALL must be specified when user *ALL or network user *ALL is specified.

Retrieve Page Data (RTVPAGDTA)

Where allowed to run:

Batch program (*BPGM)

Interactive program (*IPGM)

Threadsafe: No

The Retrieve Page Data (RTVPAGDTA) command retrieves data from a specific location in a spooled file. The requested data is returned in a Control Language (CL) program variable.

Parameters

Keyword	Description	Choices	Notes
FILE	Spooled file name	<i>Name</i> , *LASTCRT	Required, Positional 1
RTNDATA	CL var for data (1-255)	<i>Character value</i>	Required, Positional 2
PAGDTA	Page data	<i>Element list</i>	Required, Positional 3
	Element 1: Line	1-255, *STRPAGGRP, *DOCIDXTAG, *DOCIDXPAG, *DOCIDXGRP, *STRPAGGRPP, *DOCIDXTAGP, *DOCIDXGRPP	
	Element 2: Position	1-378, 0	
	Element 3: Length	1-255, 0	
PAGE	Page number	<i>Unsigned integer</i> , <u>1</u> , *LAST	Optional, Positional 4
JOB	Job name	Single values: <u>*</u> Other values: <i>Qualified job name</i>	Optional, Positional 5
	Qualifier 1: Job name	<i>Name</i>	
	Qualifier 2: User	<i>Name</i>	
	Qualifier 3: Number	000000-999999	
SPLNBR	Spooled file number	1-999999, *ONLY, * <u>LAST</u>	Optional, Positional 6

Spooled file name (FILE)

Specifies the name of the spooled file to process. CHAR(10)

This is a required parameter.

- *LASTCRT** The last spooled file created by the current job or thread is identified using the QSPRILSP API and processed. This is useful for jobs that create spooled files under other user profiles, which consequently end up in the user's QPRTJOB. When *LASTCRT is specified, the JOB() and SPLNBR() parameters are ignored.
- name** Specify the name of the spooled file.

CL var for data (1-255) (RTNDATA)

Specifies the CL variable which is to receive the data returned by the command. The variable can have a declared length between 1 and 255 and it must be as long as or longer than the requested data length. (CHAR).

This is a required parameter.

Page data (PAGDTA)

Specifies the location (line, position and length), on the page of the spooled file, from which data is retrieved. INT(2), INT(2), INT(2)

This is a required parameter.

Element 1: Line

- *STRPAGGRP** Data specified on the DDS STRPAGGRP() keyword is retrieved. These keywords inherit the page number of the next page to occur in the spooled file.
- This value is only valid with *AFPDS spooled files. Position and length are ignored as data does not appear on the

printed page and the length is derived from the value stored.

***DOCIDXTAG** Data specified on the DDS DOCIDXTAG() keyword is retrieved. Tags specified at both the "page" level and "group" level are processed. "Group" level tags inherit the page number of the next page to occur in the spooled file.

This value is only valid with *AFPDS spooled files. Position and length are ignored as data does not appear on the printed page and the length is derived from the value stored.

***DOCIXPAG** Data specified on the DDS DOCIDXTAG() keyword is retrieved. Only tags specified at the "page" level are processed.

This value is only valid with *AFPDS spooled files. Position and length are ignored as data does not appear on the printed page and the length is derived from the value stored.

***DOCIXGRP** Data specified on the DDS DOCIDXTAG() keyword is retrieved. Only tags specified at the "group" level are processed. These tags inherit the page number of the next page to occur in the spooled file.

This value is only valid with *AFPDS spooled files. Position and length are ignored as data does not appear on the printed page and the length is derived from the value stored.

***STRPAGGRP** Data specified on the DDS STRPAGGRP() keyword is retrieved. These keywords inherit the page number of the next page to occur in the spooled file and are propagated to subsequent pages in the page group. Propagation processing gives the appearance that the keyword was specified directly on each subsequent page in the group.

This value is only valid with *AFPDS spooled files. Position and length are ignored as data does not appear on the printed page and the length is derived from the value stored.

***DOCIXTAGP** Data specified on the DDS DOCIDXTAG() keyword is retrieved. Tags specified at both the "page" level and "group" level are processed. "Group" level tags inherit the page number of the next page to occur in the spooled file and are propagated to subsequent pages in the page group. Propagation processing gives the appearance that the "group" level tag was specified directly on each subsequent page in the group.

This value is only valid with *AFPDS spooled files. Position and length are ignored as data does not appear on the printed page and the length is derived from the value stored.

***DOCIXGRP** Data specified on the DDS DOCIDXTAG() keyword is retrieved. Only tags specified at the "group" level are processed. These tags inherit the page number of the next page to occur in the spooled file and are propagated to subsequent pages in the page group. Propagation processing gives the appearance that the "group" level tag was specified directly on each subsequent page in the group.

This value is only valid with *AFPDS spooled files. Position and length are ignored as data does not appear on the printed page and the length is derived from the value stored.

1-255 Specify the line number where the data is located on the page.

Element 2: Position

1-378 Specify the position where the data is located in the line. Valid values range from 1 through 378. The value specified plus the data length should be less than the number of print positions in the spooled file.

Element 3: Length

1-64 Specify the length of the data. The value specified plus the start position should be less than the number of print positions in the spooled file.

Page number (PAGE)

Specifies the page number from which data is retrieved. INT(4)

1 Data is retrieved from the first page of the spooled file.

***LAST** Data is retrieved from the last page of the spooled file.

integer Specifies the page from which data is retrieved.

Job name (JOB)

Specifies the job that contains the spooled file.

Single values

***** The job that issued the command.

Qualifier 1: Job name

name Specify the name of the job. CHAR(10)

Qualifier 2: User

name Specify the name that identifies the user profile under which the job is run. CHAR(10)

Qualifier 3: Number

000000-999999 Specify the system assigned job number. CHAR(6)

Spooled file number (SPLNBR)

Specifies the number of the spooled file. INT(4)

***LAST** The highest numbered spooled file with the specified file name is used.
***ONLY** The number of the only spooled file with the specified file name is used.
1-999999 Specify the number of the spooled file.

Examples

Example 1:

```
RTVPAGDTA      FILE (QSYSPRT)
                 RTNDATA (&CUSTNO)  PAGDTA (3 4 10)
                 JOB (033194/QPGMR/MONTHEND)  SPLNBR (2)
```

This command retrieve data from line 3, position 4 for a length of 10 from the first page in the spooled file and places the data in the variable &CUSTNO. The spooled file processed is file number 2, QSYSPRT, from job 033194/QPGMR/MONTHEND.

Retrieve Spooled File (RTVSPLF)

Where allowed to run: All environments (*ALL)

Threadsafe: No

The Retrieve Spooled File (RTVSPLF) command retrieves (recreates) a spooled file from an archive. The retrieved spooled file has the same content and attributes as the spooled file that was originally archived but is a new spooled file with a different job number and spooled file number. The new spooled file may also have a job name different from the original.

Parameters

Keyword	Description	Choices	Notes
ARC	Spooled file archive	<i>Qualified object name</i>	Required, Positional 1
	Qualifier 1: Spooled file archive	<i>Name</i> , *GEN	
	Qualifier 2: Library	<i>Name</i> , *LIBL, *CURLIB	
TOOUTQ	To output queue	Single values: *PRV Other values: <i>Qualified object name</i>	Optional, Positional 2
	Qualifier 1: To output queue	<i>Name</i>	
	Qualifier 2: Library	<i>Name</i> , *LIBL, *CURLIB	
PAGCMPDTA	Page compare data	Single values: *NONE Other values: <i>Element list</i>	Optional, Positional 3
	Element 1: Line	1-255, *ALL	
	Element 2: Position	1-378, *ALL	
	Element 3: Compare value	<i>Character value</i>	
	Element 4: Compare test	*EQ, *NE	
FILE	Spooled file name	<i>Name</i>	Optional, Positional 4
JOB	Job name	<i>Qualified job name</i>	Optional, Positional 5
	Qualifier 1: Job name	<i>Name</i>	
	Qualifier 2: User	<i>Name</i>	
	Qualifier 3: Number	000000-999999	
SPLNBR	Spooled file number	1-999999	Optional, Positional 6

Spooled file archive (ARC)

Specifies the name of the archive that contains the spooled file.

This is a required parameter.

Qualifier 1: Spooled file archive

***GEN** Generate the archive name from the supplied FILE, JOB, and SPLNBR parameters.
name Specify the name of the archive.

Qualifier 2: Library

***LIBL** All libraries in the thread's library list are searched.
***CURLIB** Use the current library for the job. If no library is specified as the current library for the job, QGPL is used.
name Specify the name of the library.

To output queue (TOOUTQ)

Specifies the name of the output queue to receive the new spooled file.

Single values

***PRV** Use the output queue specified the last time the spooled file was retrieved. If the spooled file has never been retrieved, the output queue that contained the spooled file when it was archived is used.

Qualifier 1: Output queue

name Specify the name of the output queue.

Qualifier 2: Library

***LIBL** All libraries in the thread's library list are searched.

***CURLIB** Use the current library for the job. If no library is specified as the current library for the job, QGPL is used.

name Specify the name of the library.

Page compare data (PAGCMPDTA)

Specifies the comparison that determines which pages of a spooled file are selected for output. The comparison consists of a character string value and the line and position at which it is located.

Single values

***NONE** No page comparison is performed.

Element 1: Line

1-255 Specify the line number where the comparison starts on the page.

***ALL** All lines on the page are compared. If the compare value is found on at least one line, the page is selected.

Element 2: Position

1-378 Specify the position where the comparison starts in the line. Valid values range from 1 through 378. The value specified plus the length of the compare value should be less than the number of print positions in the spooled file.

***ALL** All positions in the line are compared. If the compare value is found in at least one position, the page is selected.

Element 3: Compare value

character-value Specify the value (up to 16 characters long) to be compared with the specified line/position on the page. Only the number of characters entered are compared to the page. The value must be specified in apostrophes if it contains leading or trailing blanks. The comparison is case sensitive.

Note: Leading and trailing blanks are not allowed when *ALL is specified for character position.

Element 4: Compare test

***EQ** If the compare data is located on the page, the page is selected.

***NE** If the compare data is not located on the page, the page is selected.

Spooled file name (FILE)

Specifies the name of the spooled file to process. CHAR(10)

This is a required parameter.

name Specify the name of the spooled file.

Job name (JOB)

Specifies the job that contains the spooled file.

Single values

_ The job that issued the command.

Qualifier 1: Job name

name Specify the name of the job. CHAR(10)

Qualifier 2: User

name Specify the name that identifies the user profile under which the job is run. CHAR(10)

Qualifier 3: Number

000000-999999 Specify the system assigned job number. CHAR(6)

Spooled file number (SPLNBR)

Specifies the number of the spooled file to retrieve.

1-999999 Specify the number of the spooled file.

Examples

Example 1:

```
RTVSPLF ARC (A350390002)
```

This command retrieves (recreates) the spooled file found in the archive named A350390002. The thread's library list is used to locate the archive. The new spooled file is placed in the output queue specified the last time the command was run.

Example 2:

```
RTVSPLF ARC (HISTORY/*SPLF) FILE (QPQUPRFIL) +  
JOB (035040/QPGMR/MONTHEND) SPLNBR (2)
```

The file named QPQUPRFIL, which was spooled file number 2 in the job named MONTHEND submitted by QPGMR with number 035040, is retrieved (recreated) from the an archive in library HISTORY. The archive name is determined from the spooled file information. The new spooled file is placed in the output queue specified the last time the command was run.

Error messages

Parameter dependencies

RDM7018 When archive *SPLF is specified the FILE, JOB and SPLNBR parameters must be specified.
RDM7019 When an archive name is specified the FILE, JOB and SPLNBR parameters must be blank.

Start Report Writer (STRRPTWTR)

Where allowed to run: All environments (*ALL)

Threadsafe: No

The Start Report Writer (STRRPTWTR) command starts a report writer.

A report writer is an enhanced printer writer that is started against an output queue and processes spooled files as they become ready. Report writers provide two sets of functions. These are report distribution processing and optionally, extended printer function.

Report distribution processing consists of:

- Comparing each spooled file's attributes to the selection criteria of reports to determine a match.
- Performing distribution functions based on the report and its subscriptions. These include:
 - Adjusting copies and form type to meet current requirements.
 - Decollating (splitting) spooled files based on selection criteria specified in report filters.
 - Duplicating spooled files destined for multiple output queues.
 - Sending spooled files to network users on the local or remote systems.
 - Converting spooled files to objects (PC files).
 - Calling user process programs to perform special processing.
- Archiving spooled files for later reprinting or offline storage.
- Logging all activity to the report log.

Extended printer function consists of:

- Printing of meaningful separator pages between spooled files.
- Printing of packing slips between groups of spooled files.
- Options to print spooled files collated by form type, report group, delivery point, or recipient.

Parameters

Keyword	Description	Choices	Notes
DEV	Printer	Name, *ALL, *RMT, *SYSVAL, *NONE, *NULL	Required, Positional 1
OUTQ	Output queue	Single values: *DEV Other values: <i>Qualified object name</i>	Optional, Positional 2
	Qualifier 1: Output queue	Name	
	Qualifier 2: Library	Name, *LIBL , *CURLIB	
MSGQ	Queue for writer messages	Single values: *SYSOPR, *REQUESTER, *DEV Other values: <i>Qualified object name</i>	Optional, Positional 3
	Qualifier 1: Queue for writer messages	Name	
	Qualifier 2: Library	Name, *LIBL , *CURLIB	
DFTOUTQ	Default destination queue	Single values: *PRINT Other values: <i>Qualified object name</i>	Optional, Positional 4
	Qualifier 1: Default destination queue	Name	
	Qualifier 2: Library	Name, *LIBL , *CURLIB	
RPTLIBL	Report library list	Single values: *CURRENT, *ALL, *ALLUSR, *CURLIB, *JOB , *NONE, *LIBL Other values (up to 5 repetitions): <i>Name</i>	Optional, Positional 5
PRTOPT	Print options	<i>Element list</i>	Optional, Positional 6
	Element 1: Form type	Character value, *ALL , *FORMS	
	Element 2: Report group	Name, *ALL , *GROUPS	
	Element 3: Delivery point	Character value, *ALL , *POINTS	
	Element 4: User	Name, *ALL , *USERS	
	Element 5: Message option	*INQMSG , *MSG, *NOMSG, *INFOMSG	

SEPPGM	Separator print program	Single values: *BANNER , *PACKSLIP, *NONE, *SYSTEM Other values: <i>Qualified object name</i>	Optional, Positional 7
	Qualifier 1: Separator print program	<i>Name</i>	
	Qualifier 2: Library	<i>Name</i> , *LIBL , *CURLIB	
FILESEP	File separators	0-9, 1 , *FILE, *COPIES	Optional, Positional 8
SEPDRAWER	Drawer for separators	1-3, *FILE	Optional, Positional 9
WTR	Writer	<i>Name</i> , *DEV , *OUTQ	Optional, Positional 10
ALIGN	Align page	*WTR , *FILE	Optional, Positional 11
ARCLIB	Library to receive archive	<i>Name</i> , *NONE	Optional, Positional 12
AUTOEND	Auto-end options	<i>Element list</i>	Optional, Positional 13
	Element 1: Automatically end writer	*NO , *YES	
	Element 2: If yes, when to end	*NORDYF	
OPTIMIZE	Optimize	*DEV , *PRTOPT	Optional, Positional 14

Printer (DEV)

Specifies the name of a printer device used to print the spooled output. The device must be available before the writer can be started.

*RMT	Start a remote report writer for the output queue.
*SYSVAL	Start a report writer for the system default printer.
*NONE	The report writer performs distribution tasks only and does not drive a printer device.
*NULL	The report writer performs distribution and drives a phantom printer device. The report writer performs all printing related functions such as generating separator pages, however since no printer is present, no paper is generated.
<i>name</i>	Specify the name of the printer device for which the report writer is started.

Output queue (OUTQ)

Specifies the name of the output queue from which the report writer processes spooled files.

Single values

*DEV	The output queue associated with the printer device is used.
-------------	--

Qualifier 1: Output queue

<i>name</i>	Specify the name of the output queue.
-------------	---------------------------------------

Qualifier 2: Library

*LIBL	All libraries in the thread's library list are searched.
*CURLIB	Use the current library for the job. If no library is specified as the current library for the job, QGPL is used.
<i>name</i>	Specify the name of the library.

Queue for writer messages (MSGQ)

Specifies the name of the message queue where this report writer's messages will be sent.

Single values

*DEV	The message queue specified on the printer's device description is used. If the printer is *NONE or *NULL then *DEV acts as if *REQUESTER was specified.
*SYSOPR	The system operator's message queue QSYS/QSYSOPR is used.
*REQUESTER	The message queue associated with the user who started the report writer is used.

Qualifier 1: Message queue

<i>name</i>	Specify the name of the message queue.
-------------	--

Qualifier 2: Library

*LIBL	All libraries in the thread's library list are searched.
*CURLIB	Use the current library for the job. If no library is specified as the current library for the job, QGPL is used.
name	Specify the name of the library.

Default destination queue (DFTOUTQ)

Specifies the name of the default destination output queue.

The default destination queue is a report writer's destination output queue of last resort.

A report writer delivers spooled files in accordance with the information stored in reports and report subscriptions. The default destination output queue is used when (for example):

- A spooled file is not selected by any of the reports in the report writer's report library list.
- A report or subscription specifies ***WTR** as the destination output queue and the report writer is not processing a printer device.
- The output queue specified as the destination for a report or subscription has been deleted.
- A report or subscription specifies ***USRPRF** as the destination output queue and the user profile has been deleted.
- A report specifies **COPIES(*RPTSUB)** and there are no subscriptions.
- The spooled file remains after all subscriptions have been satisfied. This occurs when the only destinations are network IDs or user process programs.
- Processing would otherwise put the spooled file into a delivery loop.

Single values

*PRINT	The spooled file is printed.
---------------	------------------------------

Qualifier 1: Output queue

name	Specify the name of the output queue.
-------------	---------------------------------------

Qualifier 2: Library

*LIBL	All libraries in the thread's library list are searched.
*CURLIB	Use the current library for the job. If no library is specified as the current library for the job, QGPL is used.
name	Specify the name of the library.

Report library list (RPTLIBL)

Specifies the library list that is used by the report writer to locate reports.

A report library list is a list of library names used to locate reports. A report writer compares the attributes of a spooled file to the selection criteria contained in reports to determine how a spooled file should be distributed. The comparison is made with reports in the first library in the report library list. If no match is found, the report writer compares the attributes to reports in the second library in the library list. This process is continued until a match is found or the report library list is exhausted.

Within a library, reports are compared in order by their selection sequence. Reports that specify a lower sequence number are compared before reports that specify a higher sequence number.

Note: When ***JOBID**, ***ALL**, ***ALLUSR** or ***CURRENT** is specified for the report library list, all of the reports in the specified libraries are located and considered as one group for comparison. All reports in the libraries with selection sequence 1 will be considered before any report with selection sequence 2.

Single values

*JOBID	The initial library list parameter specified in job description RMRPTWTR is used to locate reports.
*CURRENT	The library list of the job running the Start Report Writer (STRRPTWTR) command is used to locate reports.

*ALL	All libraries in the system including QSYS are searched.
*ALLUSR	All non-system libraries on the machine are searched.
*CURLIB	Use the current library for the job. If no library is specified as the current library for the job, QGPL is used.
*NONE	The writer does not compare spooled files to reports to determine processing. All spooled files are delivered to the report writer's default destination queue. This value is useful for report writers that are intended to only produce separator pages and not to provide report distribution processing.
*LIBL	Do not use this value, it is allowed to preserve backward compatibility.

Other values (up to 5 repetitions)

<i>name</i>	Specify the names of one or libraries that are in the report library list. No more than 5 names can be specified; the libraries are searched in the same order as they are listed here.
--------------------	---

Print options (PRTOPT)

Specifies the report writer print options.

Print options determine which spooled files are printed and the order in which they are printed by a report writer. Only the spooled files specified are printed. All other files remain on the output queue as available. To change the options after a report writer is started, use the Change Report Writer (CHGRPTWTR) command.

Print options are made up of 5 elements.

Element 1: Form type

Spooled files are printed by form type.

*ALL	All available files on the output queue are printed regardless of their form types.
*FORMS	All available spooled files on the output queue with the same form type are printed before the writer moves to the next form type. The report writer first chooses the first available spooled file on the queue. After the first spooled file is complete, all other spooled files with the same form type are printed. The report writer again chooses the first available spooled file on the queue and repeats the process for that form type.
<i>name</i>	Specify the type of form to print.

Element 2: Report group

Spooled files are printed by report group.

*ALL	All available files on the output queue are printed regardless of their report groups.
*GROUPS	All available spooled files on the output queue from the same report group are printed before the writer moves to the next report group. The report writer first chooses the first available spooled file on the queue. After the first spooled file is complete, all other spooled files from the same report group are printed. The report writer again chooses the first available spooled file on the queue and repeats the process for that report group.
<i>name</i>	Specify the name of the report group to print.

Element 3: Delivery point

Spooled files are printed by delivery point.

*ALL	All available files on the output queue are printed regardless of their delivery points.
*POINTS	All available spooled files on the output queue for the same delivery point are printed before the writer moves to the next delivery point. The report writer first chooses the first available spooled file on the queue. After the first spooled file is complete, all other spooled files for the same delivery point are printed. The report writer again chooses the first available spooled file on the queue and repeats the process for that delivery point.
<i>name</i>	Specify the name of the delivery point to print.

Element 4: User

Spooled files are printed by user (recipient).

*ALL	All available files on the output queue are printed regardless of their users (recipients).
*USERS	All available spooled files on the output queue for the same user (recipient) are printed before the writer moves to the next user (recipient). The report writer first chooses the first available spooled file on the queue. After the first spooled file is complete, all other spooled files for the same user (recipient) are printed. The report writer again chooses the first available spooled file on the queue and repeats the process for that user (recipient).

name Specify the name of the user (recipient) whose spooled file are printed.

Element 5: Message option

Specifies the type of messages is sent.

*INQMSG	The report writer sends an inquiry to the message queue when a spooled file has form type that is different than the form type in the printer.
*NOMSG	The report writer does not send inquiry or informational messages.
*MSG	The report writer sends an inquiry to the message queue when a spooled file has form type that is different than the form type in the printer and an informational message is sent when there are no spooled files for the specified print option.
*INFOMSG	The report writer sends a message when there are no spooled files for the specified print option. As additional spooled files become available for printing, they are printed in accordance with the print options specified. The message is sent again each time the writer must wait for additional spooled files.

Separator print program (SEPPGM)

Specifies the name of a separator print program.

Note: Report Manager includes example programs with source code. Check the source file RMSOURCE and a current PTF list.

Single values

*BANNER	The Report Manager supplied banner printing program is used to create separator pages between spooled files.
*PACKSLIP	The Report Manager supplied packing slip printing program is used to create separator pages between spooled files.
*NONE	Separator pages are not printed.
*SYSTEM	No program is called to produce separator pages. Standard IBM i separators are generated based on the File separators (FILESEP) parameter value.

Qualifier 1: Program Separator print program

name Specify the name of the program.

Qualifier 2: Library

*LIBL	All libraries in the thread's library list are searched.
*CURLIB	Use the current library for the job. If no library is specified as the current library for the job, QGPL is used.
<i>name</i>	Specify the name of the library.

File separators (FILESEP)

Specifies the number of separator pages that are printed between each file.

<u>1</u>	One separator page is printed.
*FILE	The number of separator pages specified by each spooled file is used.
*COPIES	The number of separator pages is the same as the number of spooled file copies.
0-9	Specify a number of separator pages to print.

Drawer for separators (SEPDRAWER)

Specifies which paper drawer is selected for printing separators.

*FILE	The separator pages are printed from the same drawer as the spooled file.
1-3	Specify a number from 1 to 3 of the drawer from which separators are printed.

Writer (WTR)

Specifies the name of the report writer being started. Each writer name must be unique.

*DEV	The name of the printer device processed by the writer is used. If the printer device is *NONE the name of the
-------------	--

***OUTQ** output queue is used.
name The name of the output queue processed by the writer is used.
Specify the name of the report writer.

Align page (ALIGN)

The Align page parameter determines how to control forms alignment.

***WTR** The writer keeps track of the output and issues a forms alignment message whenever it determines that forms may need to be aligned.
***FILE** The forms alignment message is issued for every file that has *YES specified for the Align page prompt (ALIGN parameter). This option should be taken whenever the automatic forms alignment control provided by the writer does not provide the desired results.

Library to receive archive (ARCLIB)

Specifies the library that receives the archives created by report writers for each spooled file processed.

Note: A "Library to receive archive" (ARCLIB) parameter is provided on both reports and report writers. When both are specified, the report takes precedence.

***NONE** Report writers do not create an archive from each spooled file processed.
name Specify the name of the library.

Auto-end options (AUTOEND)

Specifies whether the writer ends automatically.

Element 1: Automatically end writer

***NO** The report writer does not end when the last available file has been processed from the output queue; it waits for another spooled file to arrive on the queue.
***YES** The report writer automatically ends after it has reached the state specified in the second part of this parameter.

Element 2: If yes, when to end

***NORDYF** The report writer automatically ends when all available files have been processed.

Optimize (OPTIMIZE)

Specifies how processing should be optimized.

As a report writer is processing spooled files, it invariably comes to a point where the printer is idle and there are more spooled files to process. In this situation there are two choices. These are to optimize the device by providing work for the printer even though this may cause the print order specified by the print options to be violated, or to optimize the print order by allowing the printer to remain idle for a time to insure that the print options are honored. The optimize parameter specifies which choice the report writer makes.

Note: The device is always optimized when no print options have been specified.

***PRTOPT** Optimize printing according to the print options at the expense of printer through put.
***DEV** Optimize printer through put at the expense of the print options.

Examples

Example 1:

```
STRRPTWTR  DEV (PRT01)  RPTLIBL (REPORTS)
            PRTOPT (*ALL *ALL *POINTS)
```

This command starts a report writer to distribute spooled files for the printer PRT01. The writer locates the reports that it processes in the library named REPORTS. Printing on the device PRT01 occurs in order by delivery point names. Large letter separator pages print between spooled files.

Example 2:

```
STRRPTWTR  DEV (*NONE)  OUTQ (QPRINT)  DFTOUTQ (HOLD)
           RPTLIBL (REPORTS)
```

This command starts a report writer that is not attached to a printer device, and performs report distribution activities only. Spooled files from the output queue QPRINT are processed and delivered according to the information in reports found in a library named REPORTS. Any spooled files that are not identified by a report, and any reports or subscriptions that do have an explicit destination are delivered to an output queue named HOLD.

Example 3:

```
STRRPTWTR  DEV (*SYSVAL) RPTLIBL (*NONE)
```

This command starts a report writer that does not process reports, and only prints large letter separator pages between spooled files for the system default printer device.

Example 4:

```
STRRPTWTR  DEV (*NONE)  OUTQ (QPRINT)  MSGQ (*REQUESTER)
           DFTOUTQ (QPRINTS) RPTLIBL (*NONE)
           ARCLIB (ARCHIVES)  AUTOEND (*YES)
```

This command starts a report writer that does not process reports, and only creates an archive for every spooled file in output queue QPRINT. Each spooled file is placed on output queue QPRINTS after it has been archived. The report writer ends automatically after every spooled file in output queue QPRINT has been processed.

Error messages

Parameter dependencies

RDM7001	DEV(*NONE) and OUTQ(*DEV) are mutually exclusive.
RDM7002	DEV(*NONE) and DFTOUTQ(*PRINT) are mutually exclusive.
RDM7031	DEV(*NULL) and OUTQ(*DEV) are mutually exclusive.
RDM7028	DEV(*NULL) and DFTOUTQ(*PRINT) are mutually exclusive.
RDM7024	SEPPGM(*SYSTEM) and FILESEP(*COPIES) are mutually exclusive.
RDM7032	DEV(*RMT) and OUTQ(*DEV) are mutually exclusive.

Verify/Set Up Local SMTP (VFYLOCAL)

Where allowed to run: All environments (*ALL)

Threadsafe: No

The Verify/Set Up Local SMTP (VFYLOCAL) command verifies or sets up SMTP on the local system.

Parameters

Keyword	Description	Choices	Notes
SETUP	Make changes to system	<u>*NO</u> , *YES, Y, N	Optional, Positional 1

Make changes to system (SETUP)

Specifies the whether the command makes changes to the system.

- *NO** The command does not make changes to the local system.
- *YES** The command makes changes to the local system.

Examples

Example 1:

```
VFYLOCAL    SETUP (*NO)
```

This command verifies that SMTP is set up correctly on the local system.

Example 2:

```
VFYLOCAL    SETUP (*YES)
```

This command sets up SMTP on the local system.

Verify/Set Up Mailhub Server (VFYMAILHUB)

Where allowed to run: All environments (*ALL)

Threadsafe: No

The Verify/Set Up Mailhub Server (VFYMAILHUB) command verifies or sets up a forwarding mailhub server for use by the local system.

Note: If a mailhub has previously been configured, this command can not be used to change it.

Parameters

Keyword	Description	Choices	Notes
RMTSYS	Remote system	<i>Character value</i> , *MAILHUB, *INTNETADR	Optional
INTNETADR	Remote internet address	<i>Character value</i> , *RMTSYS, *MAILHUB	Optional
SETUP	Make changes to system	*YES, *NO, Y, N	Optional

Remote system (RMTSYS)

Specifies the remote system name of the host with which the Verify/Set Up Mailhub Server operation takes place. To be successful, the name must be valid, and the remote system must be able to communicate with the local system.

- *MAILHUB The name of the configured SMTP forwarding mailhub server is used.
- *INTNETADR The INTNETADR parameter is used.
- character-value* Specify the remote system name to use.

Remote internet address (INTNETADR)

Specifies the remote internet address. The internet address is specified in the form **nnn.nnn.nnn.nnn**, where **nnn** is a decimal number ranging from 0 through 255. An internet address is not valid if it has a value of all binary ones or all binary zeros for the network identifier (ID) portion or the host ID portion of the address. If the internet address is entered from a command line, enclose the address in apostrophes.

- *RMTSYS The internet address of the specified remote system is used.
- *MAILHUB The internet address of the configured SMTP forwarding mailhub server is used.
- character-value* Specify the internet address to use.

Make changes to system (SETUP)

Specifies the whether the command makes changes to the system.

- *NO The command does not make changes to the local system.
- *YES The command makes changes to the local system.

Examples

Example 1:

```
VFYMAILHUB RMTSYS (*MAILHUB) SETUP (*NO)
```

Command verifies that the currently configured forwarding mailhub server is set up and operating correctly.

Example 2:

```
VFYMAILHUB RMTSYS (sys1.widget.com)
            INTNETADR (192.168.1.2) SETUP (*YES)
```

This command sets up sys1.widget.com at address 192.168.1.2 as the forwarding mailhub server for this System i.

Error messages

Parameter dependencies

MSU7011 RMTSYS(*INTNETADR) and INTNETADR(*RMTSYS) are mutually exclusive.

Verify/Set Up Mail Router (VFYROUTER)

Where allowed to run: All environments (*ALL)
Threadsafe: No

Note: THIS COMMAND HAS BEEN SUPERCEDED AND WILL BE REMOVED IN A FUTURE RELEASE. Use Verify/Set Up Mailhub Server (VFYMAILHUB) instead.

The Verify/Set Up Mail Router (VFYROUTER) command verifies or sets up a remote mail router for use by the local system.

Note: If a mail router has previously been configured, this command can not be used to change it.

Parameters

Keyword	Description	Choices	Notes
RMTSYS	Remote system	Character value, *ROUTER , *INTNETADR	Optional, Positional 1
INTNETADR	Remote internet address	Character value, *RMTSYS , *ROUTER	Optional, Positional 2
SETUP	Make changes to system	*YES, *NO , Y, N	Optional, Positional 3

Remote system (RMTSYS)

Specifies the remote system name of the host with which the Verify/Set Up Mail Router operation takes place. To be successful, the name must be valid, and the remote system must be able to communicate with the local system.

- *ROUTER** The name of the configured SMTP mail router is used.
- *INTNETADR** The INTNETADR parameter is used.
- character-value** Specify the remote system name to use.

Remote internet address (INTNETADR)

Specifies the remote internet address. The internet address is specified in the form **nnn.nnn.nnn.nnn**, where **nnn** is a decimal number ranging from 0 through 255. An internet address is not valid if it has a value of all binary ones or all binary zeros for the network identifier (ID) portion or the host ID portion of the address. If the internet address is entered from a command line, enclose the address in apostrophes.

- *RMTSYS** The internet address of the specified remote system is used.
- *ROUTER** The internet address of the configured SMTP mail router is used.
- character-value** Specify the internet address to use.

Make changes to system (SETUP)

Specifies the whether the command makes changes to the system.

- *NO** The command does not make changes to the local system.
- *YES** The command makes changes to the local system.

Examples

Example 1:

```
VFYROUTER RMTSYS (*ROUTER) SETUP (*NO)
```

Command verifies that the currently configured mail router is set up and operating correctly.

Example 2:

```
VFYROUTER RMTSYS (sys1.widget.com)
           INTNETADR (192.168.1.2) SETUP (*YES)
```

This command sets up sys1.widget.com at address 192.168.1.2 as the mail router for this System i.

Error messages

Parameter dependencies

MSU7011 RMTSYS(*INTNETADR) and INTNETADR(*RMTSYS) are mutually exclusive.

Work with Form Types (WRKFRMTYP)

Where allowed to run: All environments (*ALL)

Threadsafe: No

The Work with Form Types (WRKFRMTYP) command shows a list of form types and provides options to work with them.

Parameters

Keyword	Description	Choices	Notes
FRMTYP	Form type	<i>Character value</i> , *ALL	Required, Positional 1
OUTPUT	Output	<i>_</i> , *PRINT	Optional, Positional 2

Form type (FRMTYP)

Specifies the name of the form type.

This is a required parameter.

<i>name</i>	Specify the name of the form type.
<i>generic-name</i>	Specify a generic name. Form types whose names begin with the specified characters are selected.
*ALL	All form type names are selected.

Output (OUTPUT)

Specifies where the output from the command is sent. CHAR(10)

<i>_</i>	The output is displayed (if requested by an interactive job) or printed with the job's spooled output (if requested by a batch job).
*PRINT	The output is printed with the job's spooled output.

Examples

Example 1:

```
WRKFRMTYP FRMTYP (WIDE*)
```

This command shows a list of form types whose names begin with WIDE*. Options may be selected from the resulting display to work with the form types that are listed.

Example 2:

```
WRKFRMTYP FRMTYP (*ALL)
```

This command shows a list of all form types known to Report Manager. Options may be selected from the resulting display to work with the form types that are listed.

Work with Reports (WRKRPT)

Where allowed to run: All environments (*ALL)

Threadsafe: No

The Work with Reports (WRKRPT) command shows a list of reports from one or more libraries.

Parameters

Keyword	Description	Choices	Notes
RPT	Report	<i>Qualified object name</i>	Required,
	Qualifier 1: Report	<i>Generic name, name, *ALL</i>	Positional 1
	Qualifier 2: Library	<i>Name, *LIBL, *CURLIB, *USRLIBL, *ALLUSR, *ALL</i>	
OUTPUT	Output	<i>*, *PRINT</i>	Optional, Positional 2

Report (RPT)

Specifies the name of the report and the library where it resides.

This is a required parameter.

Qualifier 1: Report

- name*** Specify the name of the report.
- generic-name*** Specify a generic name. Reports whose names begin with the specified characters are selected.
- *ALL** All reports in the library or libraries are selected.

Qualifier 2: Library

- *LIBL** All libraries in the thread's library list are searched.
- *CURLIB** Use the current library for the job. If no library is specified as the current library for the job, QGPL is used.
- *USRLIBL** Only the libraries in the user portion of the thread's library list are searched.
- *ALL** All libraries in the system including QSYS are searched.
- *ALLUSR** All non-system libraries on the machine are searched.
- name*** Specify the name of the library.

Output (OUTPUT)

Specifies where the output from the command is sent. CHAR(10)

- _** The output is displayed (if requested by an interactive job) or printed with the job's spooled output (if requested by a batch job).
- *PRINT** The output is printed with the job's spooled output.

Examples

Example 1:

```
WRKRPT RPT (MYLIB/INV*)
```

This command shows a list of reports from library MYLIB whose names begin with "INV". Options may be selected from the resulting display to work with the reports that are listed.

Example 2:

```
WRKRPT RPT (REPORTS/*ALL)
```

This command shows a list of all reports from library REPORTS. Options may be selected from the resulting display to work with the reports that are listed.

Work with Report Filters (WRKRPTFTR)

Where allowed to run: All environments (*ALL)

Threadsafe: No

The Work with Report Filters (WRKRPTFTR) command shows a list of filters from a report.

A report filter specifies test criteria for a report that are used to reduce the number of pages delivered for a subscription. After a filter has been added to a report, it may be specified on one or more subscriptions. When a report writer processes the subscription, it tests each page of the spooled file against the filter criteria to determine if the page is selected for distribution. A page is selected when the data on the page meets the criteria specified.

All selected pages are placed in a new spooled file. If the user data (USRDTA) attribute of the original spooled file is blank, the new spooled file has the filter's name for user data.

Parameters

Keyword	Description	Choices	Notes
RPT	Report	<i>Qualified object name</i>	Required, Positional 1
	Qualifier 1: Report	<i>Name</i>	
	Qualifier 2: Library	<i>Name, *LIBL, *CURLIB</i>	
RPTFTR	Report filter	<i>Generic name, name, *ALL</i>	Optional, Positional 2
OUTPUT	Output	<i>_, *PRINT, *OUTFILE</i>	Optional, Positional 3
OUTFILE	File to receive output	<i>Qualified object name</i>	Optional, Positional 4
	Qualifier 1: File to receive output	<i>Name</i>	
	Qualifier 2: Library	<i>Name, *LIBL, *CURLIB</i>	
OUTMBR	Output member options	<i>Element list</i>	Optional, Positional 5
	Element 1: Member to receive output	<i>Name, *FIRST</i>	
	Element 2: Replace or add records	<i>*REPLACE, *ADD</i>	

Report (RPT)

Specifies the name of the report and the library where it resides.

This is a required parameter.

Qualifier 1: Report

name Specify the name of the report.

Qualifier 2: Library

***LIBL** All libraries in the thread's library list are searched.

***CURLIB** Use the current library for the job. If no library is specified as the current library for the job, QGPL is used.

name Specify the name of the library.

Report filter (RPTFTR)

Specifies the name of the report filter. Filter names are unique within a report.

***ALL** All filters in the report are selected.

generic-name Specify a generic name. Filters whose names begin with the specified characters are selected.

name Specify the name of the filter.

Output (OUTPUT)

Specifies where the output from the command is sent. CHAR(10)

_ The output is displayed (if requested by an interactive job) or printed with the job's spooled output (if requested by a batch job).

- *PRINT** The output is printed with the job's spooled output.
***OUTFILE** The output is directed to the database file specified on the **File to receive output** prompt (OUTFILE parameter).
-

File to receive output (OUTFILE)

Specifies the name and library of the database file to which the output of the command is directed. If the file does not exist, the command creates one in the specified library. CHAR(10) CHAR(10)

Qualifier 1: File to receive output

name Specify the name of the file to which the output of the command is directed.

Qualifier 2: Library

- *LIBL** All libraries in the thread's library list are searched.
***CURLIB** Use the current library for the job. If no library is specified as the current library for the job, QGPL is used.
name Specify the name of the library.
-

Output member options (OUTMBR)

Specifies the name of the database file member that receives the output of the command. CHAR(10) CHAR(10)

Element 1: Member to receive output

- *FIRST** The first member in the file receives the output. If it does not exist, the system creates a member with the name of the file specified in the **File to receive output** prompt (OUTFILE parameter). If the member already exists, you have the option to add new records to the end of the existing member or clear the member and then add the new records.
name Specify the name of the member that receives the output. If it does not exist, the system creates it.

Element 2: Replace or add records

- *REPLACE** The system clears the existing member and adds the new records.
***ADD** The system adds the new records to the end of the existing records.
-

Examples

Example 1:

```
WRKRPTFTR RPT (INV310)
```

This command shows a list of all filters in the report INV310. The report is located using the thread's library list.

Example 2:

```
WRKRPTFTR RPT (REPORTS/SOE112) RPTFTR (REG*)
```

This command shows a list of filters from the report INV310 found in library REPORTS. The list shows all filters whose names begin with REG*.

Error messages

Parameter dependencies

- GCM7014** OUTFILE parameter required with OUTPUT(*OUTFILE).
GCM7015 OUTFILE parameter can only be specified with OUTPUT(*OUTFILE).
GCM7016 OUTMBR parameter can only be specified with OUTPUT(*OUTFILE).

Work with Report Output Queue (WRKRPTOUTQ)

Where allowed to run: All environments (*ALL)

Threadsafe: No

The Work with Report Output Queue (WRKRPTOUTQ) command shows the detailed status of a specific output queue. All spooled files on the output queue are displayed including those not yet processed by a report writer.

Parameters

Keyword	Description	Choices	Notes
OUTQ	Output queue	<i>Qualified object name</i>	Required, Positional 1
	Qualifier 1: Output queue	<i>Name</i>	
	Qualifier 2: Library	<i>Name, *LIBL, *CURLIB</i>	
OUTPUT	Output	<i>*, *PRINT _</i>	Optional, Positional 2

Output queue (OUTQ)

Specifies the name of the Output queue and the library where it resides.

This is a required parameter.

Qualifier 1: Output queue

name Specify the name of the output queue.

Qualifier 2: Library

***LIBL** All libraries in the thread's library list are searched.

***CURLIB** Use the current library for the job. If no library is specified as the current library for the job, QGPL is used.

name Specify the name of the library.

Output (OUTPUT)

Specifies where the output from the command is sent. CHAR(10)

_ The output is displayed (if requested by an interactive job) or printed with the job's spooled output (if requested by a batch job).

***PRINT** The output is printed with the job's spooled output.

Examples

Example 1:

```
WRKRPTOUTQ OUTQ(QPRINT)
```

This command shows a list of all spooled files in output queue QPRINT. The output queue is located using the thread's library list.

Example 2:

```
WRKRPTOUTQ OUTQ(QUSRSYS/PRT01)
```

This command shows a list of all spooled files in output queue PRT01 in library QUSRSYS.

Work with Report Spooled Files (WRKRPTSPLF)

Where allowed to run: All environments (*ALL)

Threadsafe: No

The Work with Report Spooled Files (WRKRPTSPLF) command displays a list of selected spooled files that have been processed by a report writer. The display can be restricted by report, by output queue, by time period and by additional selection criteria.

Information displayed by the command is driven by the contents of the report distribution log. Entries for spooled files that are no longer on the system are displayed as long as information is still available in the report distribution log. Conversely, spooled files will not appear unless they have been processed by a report writer. The logical or original spooled file identities are shown for each spooled file.

As a report writer processes spooled files, duplicate copies may be generated to complete distribution. "Logical spooled file" refers to the spooled file that was copied.

Parameters

Keyword	Description	Choices	Notes
SELECT	Select files delivered for	<i>Element list</i>	Optional, Positional 1
	Element 1: User	Name, *CURRENT , *ALL, *NONE, *USRID	
	Element 2: Network user ID	Name, *ALL , *NONE	
	Element 3: Network address	Name, *ALL	
	Element 4: Report group	Name, *ALL	
	Element 5: Delivery point	Character value, *ALL	
STATUS	Status	*ALL , *AVAIL, *ARCHIVED, *SPLF	Optional, Positional 2
PERIOD	Time period	<i>Element list</i>	Optional, Positional 3
	Element 1: Starting time and date	<i>Element list</i>	
	Element 1: Starting time	Time, *AVAIL	
	Element 2: Starting date	Date, *CURRENT , *BEGIN	
	Element 2: Ending time and date	<i>Element list</i>	
	Element 1: Ending time	Time, *AVAIL	
	Element 2: Ending date	Date, *CURRENT , *END	
RPT	Report	Single values: *ALL , *NONE Other values: <i>Qualified object name</i>	Optional, Positional 4
	Qualifier 1: Report	Name	
	Qualifier 2: Library	Name, *LIBL , *CURLIB	
OUTQ	Output queue	Single values: *ALL Other values: <i>Qualified object name</i>	Optional, Positional 5
	Qualifier 1: Output queue	Name	
	Qualifier 2: Library	Name, *LIBL , *CURLIB	
OUTPUT	Output	*_ *PRINT	Optional, Positional 6

Select files delivered for (SELECT)

Specifies the criteria used to further select spooled files for display. Selection criteria consist of 5 elements. Only spooled files that match each of the values are selected.

Element 1: User

- *CURRENT** Spooled files delivered to the user of the current job are selected.
- *ALL** All spooled files are selected regardless of their users (recipients).
- *NONE** Spooled files delivered to user name (recipient) ***NONE** are selected.
- name** Specify a user (recipient) name. Only spooled files delivered to the user are selected.

Element 2: Network user ID

- *ALL** All spooled files are selected regardless of their user IDs.

user-id Specify a network user id. Only spooled files delivered to the user ID are selected.

Element 3: Network address

***ALL** All spooled files are selected regardless of their addresses.
address Specify a network address. Only spooled files delivered to the address are selected.

Element 4: Report group

***ALL** All spooled files are selected regardless of their report groups.
name Specify a report group name. Only spooled files from the group are selected.

Element 5: Delivery point

***ALL** All spooled files are selected regardless of their delivery points.
name Specify a delivery point name. Only spooled files for the delivery point are selected.

Status (STATUS)

Specifies the status of spooled files selected for display.

***ALL** All spooled files are selected for display regardless of their status.
***AVAIL** Only spooled files that are available are displayed. A spooled file is available if it is still on the system or if it was archived.
***ARCHIVED** Only spooled files that were archived are displayed.
***SPLF** Only spooled files that are still on the system are displayed.

Period (PERIOD)

Specifies the time period for which spooled files are shown. Time period refers to the time and date as shown in the report distribution log and not the time and date the spooled file was created. The following values can be coded for this parameter, which contains two lists of two values each.

Element 1: Starting time and date

Element 1: Starting time One of the following specifies the starting time from which entries are shown. Entries logged before this time on the **Starting date** are not shown.

***AVAIL** All data that is available for the specified date is shown.
time Specify the start time from which data for the specified date is shown. The time is specified in 24-hour format and can be specified with or without a time separator:

- Without a time separator, specify a string of 4 or 6 digits (hhmm or hhmmss) where hh = hours, mm = minutes, and ss = seconds.
- With a time separator, specify a string of 5 or 8 digits where the time separator specified for your job is used to separate the hours, minutes, and seconds. If you enter this command from the command line, the string must be enclosed in apostrophes. If a time separator other than the separator specified for your job is used, this command will fail.

Element 2: Starting date One of the following specifies the starting date from which entries are shown. Entries logged before this date are not shown.

***CURRENT** The current date is used.
***BEGIN** The data from the beginning of the log is shown.
date Specify the start date from which data is shown. The date must be specified in the job date format.

Element 2: Ending time and date

Element 1: Ending time One of the following specifies the ending time to which entries are shown. Entries logged after this time on the **Ending date** are not shown.

***AVAIL** All data that is available for the specified date is shown.
time Specify the end time to which data for the specified date is shown. The time is specified in 24-hour format and can be specified with or without a time separator:

- Without a time separator, specify a string of 4 or 6 digits (hhmm or

- hhmmss) where hh = hours, mm = minutes, and ss = seconds.
- With a time separator, specify a string of 5 or 8 digits where the time separator specified for your job is used to separate the hours, minutes, and seconds. If you enter this command from the command line, the string must be enclosed in apostrophes. If a time separator other than the separator specified for your job is used, this command will fail.

Element 2: Ending date One of the following specifies the ending date to which entries are shown. Entries logged after this date are not shown.

*CURRENT	The current date is used.
*END	The data to the end of the log is shown.
date	Specify the end date to which data is shown. The date must be specified in the job date format.

Report (RPT)

Specifies the name of the report and the library where it resides.

Single values

*ALL	All reports are selected.
*NONE	Specifies entries with no associated report name.

Qualifier 1: Report

name	Specify the name of the report.
-------------	---------------------------------

Qualifier 2: Library

*LIBL	All libraries in the thread's library list are searched.
*CURLIB	Use the current library for the job. If no library is specified as the current library for the job, QGPL is used.
name	Specify the name of the library.

Output queue (OUTQ)

Specifies the name of the Output queue and the library where it resides.

Single values

*ALL	Spoiled files from all output queues are selected.
-------------	--

Qualifier 1: Output queue

name	Specify the name of the output queue.
-------------	---------------------------------------

Qualifier 2: Library

*LIBL	All libraries in the thread's library list are searched.
*CURLIB	Use the current library for the job. If no library is specified as the current library for the job, QGPL is used.
name	Specify the name of the library.

Output (OUTPUT)

Specifies where the output from the command is sent. CHAR(10)

*	The output is displayed (if requested by an interactive job) or printed with the job's spooled output (if requested by a batch job).
*PRINT	The output is printed with the job's spooled output.

Examples

Example 1:

WRKRPTSPLF

This command displays a list of all spooled files that were delivered today to the user executing the command.

Example 2:

```
WRKRPTSPLF STATUS (*SPLF)
```

This command displays a list of spooled files that were delivered today to the user executing the command. Only those spooled files that are still on the system are shown.

Example 3:

```
WRKRPTSPLF SELECT (*ALL JOE SEATTLE)
            PERIOD (*AVAIL *BEGIN) (*AVAIL *END))
            RPT (REPORTS/INV310)
```

This command displays a list of all spooled files for the report INV310 in library REPORTS that were delivered to the network user JOE SEATTLE. All available log entries are searched.

Error messages

Parameter dependencies

RDM7020	When a user name is specified a network user ID cannot be specified.
RDM7021	When a user name is specified a network address cannot be specified.
RDM7022	When a network user ID is specified a network address must also be specified.
RDM7023	When a network address is specified a network user ID must also be specified.

Work with Report Subscriptions (WRKRPTSUB)

Where allowed to run: All environments (*ALL)

Threadsafe: No

The Work with Report Subscriptions (WRKRPTSUB) command shows a list of subscriptions for one or more subscribers from one or more reports.

Parameters

Keyword	Description	Choices	Notes
RPT	Report	<i>Qualified object name</i>	Required, Positional 1
	Qualifier 1: Report	<i>Generic name, name, *ALL</i>	
	Qualifier 2: Library	<i>Name, *LIBL, *CURLIB, *USRLIBL, *ALLUSR, *ALL</i>	
USER	User	<i>Name, *CURRENT, *CREATOR, *USRID, *CREATOR2, *ALL</i>	Optional, Positional 2
USRID	Network user	Single values: <i>*NONE, *ALL, *SPLFCRT, *SPLFOWN</i> Other values: <i>Element list</i>	Optional, Positional 3
	Element 1: User ID	<i>Character value</i>	
	Element 2: Address	<i>Character value</i>	
SUBNBR	Subscription number	1-255, <i>*ALL</i>	Optional, Positional 4
OUTPUT	Output	<i>*, *PRINT, *OUTFILE</i>	Optional, Positional 5
OUTFILE	File to receive output	<i>Qualified object name</i>	Optional, Positional 6
	Qualifier 1: File to receive output	<i>Name</i>	
	Qualifier 2: Library	<i>Name, *LIBL, *CURLIB</i>	
OUTMBR	Output member options	<i>Element list</i>	Optional, Positional 7
	Element 1: Member to receive output	<i>Name, *FIRST</i>	
	Element 2: Replace or add records	<i>*REPLACE, *ADD</i>	
DETAIL	Detail	<i>*BASIC, *FULL</i>	Optional, Positional 8

Report (RPT)

Specifies the name of the report and the library where it resides.

This is a required parameter.

Qualifier 1: Report

- name*** Specify the name of the report.
- generic-name*** Specify a generic name. Reports whose names begin with the specified characters are selected.
- *ALL** All reports in the library or libraries are selected.

Qualifier 2: Library

- *LIBL** All libraries in the thread's library list are searched.
- *CURLIB** Use the current library for the job. If no library is specified as the current library for the job, QGPL is used.
- *USRLIBL** Only the libraries in the user portion of the thread's library list are searched.
- *ALL** All libraries in the system including QSYS are searched.
- *ALLUSR** All non-system libraries on the machine are searched.
- name*** Specify the name of the library.

User (USER)

Specifies the user who is subscribed to the report.

- *CURRENT** The subscription is for the user of the current job.
- *CREATOR** The subscription is for the user creating the spooled file. Report writers resolve this value using the user portion of the qualified job name that contains the spooled file.

*CREATOR2	The subscription is for the user creating the spooled file. Report writers resolve this value using information in the spooled file's attributes. Use this value if the spooled file was originally created on another system.
*USRID	The subscription is for the network user identified by the USRID parameter.
*ALL	Specifies the subscriptions for every user.
<i>name</i>	Specify the name of the user profile.

Network user (USRID)

Specifies the network user who is subscribed to the report. A network user receives subscriptions on the local system or on a remote system as email or through the SNADS network. For email, subscriptions are delivered as a message with the spooled file placed in an attached file. For SNADS networks, subscriptions are placed on the output queue specified in the user profile of the network user. Network users are identified by a two part user ID or by a two part distribution list ID.

A network user receives subscriptions on the local system or on a remote system as email or through the SNADS network. For email, subscriptions are delivered as a message with the spooled file placed in an attached file. For SNADS networks, subscriptions are placed on the output queue specified in the user profile of the network user. Network users are identified by a two part user ID or by a two part distribution list ID.

Single values

*NONE	The subscription is not for a network user.
*ALL	Specifies the subscriptions for every network user.
*SPLFCRT	The subscription is for the user creating the spooled file. Report writers resolve this value using information in the spooled file's attributes. Use this value if the spooled file was originally created on another system. The directory entry for the user profile is retrieved to determine the target User ID and Address.
*SPLFOWN	The subscription is for the user owning the spooled file. Report writers resolve this value using the user portion of the qualified job name that contains the spooled file. The directory entry for the user profile is retrieved to determine the target User ID and Address.

Element 1: User ID

character-value Specify the user ID (DEN) of the network user. CHAR(8)

Element 2: Address

character-value Specify the address (DGN) of the network user. CHAR(8)

Subscription number (SUBNBR)

Specifies the subscription number. Subscription numbers uniquely identify the subscriptions of an individual subscriber to a report. This allows a user or network user to subscribe to a report more than once.

Subscription numbers uniquely identify the subscriptions of an individual subscriber to a report. Subscription numbers allow a subscriber to subscribe to a report more than once.

*ALL	Specifies all subscriptions for the subscriber.
1-255	Specify a subscription number.

Output (OUTPUT)

Specifies where the output from the command is sent. CHAR(10)

*	The output is displayed (if requested by an interactive job) or printed with the job's spooled output (if requested by a batch job).
*PRINT	The output is printed with the job's spooled output.
*OUTFILE	The output is directed to the database file specified on the File to receive output prompt (OUTFILE parameter).

File to receive output (OUTFILE)

Specifies the name and library of the database file to which the output of the command is directed. If the file does not exist, the command creates one in the specified library. CHAR(10) CHAR(10)

Qualifier 1: File to receive output

name Specify the name of the file to which the output of the command is directed.

Qualifier 2: Library

***LIBL** All libraries in the thread's library list are searched.

***CURLIB** Use the current library for the job. If no library is specified as the current library for the job, QGPL is used.

name Specify the name of the library.

Output member options (OUTMBR)

Specifies the name of the database file member that receives the output of the command. CHAR(10) CHAR(10)

Element 1: Member to receive output

***FIRST** The first member in the file receives the output. If it does not exist, the system creates a member with the name of the file specified in the **File to receive output** prompt (OUTFILE parameter). If the member already exists, you have the option to add new records to the end of the existing member or clear the member and then add the new records.

name Specify the name of the member that receives the output. If it does not exist, the system creates it.

Element 2: Replace or add records

***REPLACE** The system clears the existing member and adds the new records.

***ADD** The system adds the new records to the end of the existing records.

Detail (DETAIL)

Specifies how much detail is directed to the database file. This parameter is not used unless *OUTFILE is specified on the **Output** prompt (OUTPUT parameter).

***BASIC** The database file contains the information entered on the Add Report Subscription (ADDRPTSUB) command. The format of the data is defined by model output file RMSUBB in the library RPTMGR with record format name RMSUBBR.

***FULL** The database file contains the information entered on the Add Report Subscription (ADDRPTSUB) command. In addition the database file contains information from the report. The format of the data is defined by model output file RMSUBF in the library RPTMGR with record format name RMSUBFR.

Examples

Example 1:

```
WRKRPTSUB RPT (REPORTS/INV*)
```

This command shows a list of subscriptions for the user issuing the command. All reports whose names begin with "INV" from the library REPORTS are searched.

Example 2:

```
WRKRPTSUB RPT (REPORTS/INV310) USER (*USRID) USRID (*ALL)
```

This command shows a list of subscriptions from the report INV310 found in library REPORTS. The list shows subscriptions for all remote users.

Example 3:

```
WRKRPTSUB RPT (*ALL/MKRPT*) USER (*USRID) USRID (BSMITH SEATTLE)
```

This command shows a list of subscriptions for network user BSMITH at SEATTLE from all reports whose names begin with "MKRPT". All libraries on the system are searched.

Error messages

Parameter dependencies

RDM7006	When user *USRID is specified a network user must be specified.
RDM7012	A network user or a user can be specified, but not both.
RDM7007	When network user *NONE is specified user *USRID cannot be specified.
RDM7005	When user *ALL is specified a specific network user cannot be specified.
RDM7004	When network user *ALL is specified user *USRID or user *ALL must also be specified.
RDM7003	Subscription number *ALL must be specified when user *ALL or network user *ALL is specified.
GCM7014	OUTFILE parameter required with OUTPUT(*OUTFILE).
GCM7015	OUTFILE parameter can only be specified with OUTPUT(*OUTFILE).
GCM7016	OUTMBR parameter can only be specified with OUTPUT(*OUTFILE).
RDM7017	DETAIL parameter can only be specified with OUTPUT(*OUTFILE).

Work with Report Writer (WRKRPTWTR)

Where allowed to run: All environments (*ALL)

Threadsafe: No

The Work with Report Writer (WRKRPTWTR) command gives the status of report writers. This can be the overall status of all report writers, or the detailed status of a specific report writer.

Parameters

Keyword	Description	Choices	Notes
WTR	Writer	<i>Name</i> , *ALL	Optional, Positional 1
OUTPUT	Output	* , *PRINT	Optional, Positional 2

Writer (WTR)

Specifies the name of the report writer.

***ALL** All report writers are selected.
name Specify the name of the report writer.

Output (OUTPUT)

Specifies where the output from the command is sent. CHAR(10)

***** The output is displayed (if requested by an interactive job) or printed with the job's spooled output (if requested by a batch job).
***PRINT** The output is printed with the job's spooled output.

Examples

Example 1:

```
WRKRPTWTR DEV (PRT01)
```

This command displays detailed information about the report writer PRT01.

Example 2:

```
WRKRPTWTR DEV (QSYSPRT) OUTPUT (*PRINT)
```

This command prints detailed information about the report writer QSYSPRT.

Chapter 8 Advanced Topics

What's In This Chapter

This chapter provides information on Report Manager advanced topics. The chapter:

- Discusses subscription destinations and parameters.
- Discusses report writer internal construction.
- Discusses report writer selection logic.
- Discusses report writer separator programs.
- Discusses report writer spooled file limit and writer restart.
- Discusses IBM i output queue selection logic.
- Discusses Report Manager output queue selection logic.
- Discusses report writer redelivery logic.
- Discusses archive naming.
- Discusses archive restore programs.
- Discusses log purge programs.

Subscription Destinations and Parameters

This section describes the various destinations for subscriptions and the relationships between the parameters found on the Add Report Subscription (ADDRPTSUB) command.

Subscriptions fall into 2 broad categories based on the type of subscriber. These are:

- Local user** Identified by the user (USER) parameter containing a user profile.
- Network user** Identified by the user (USER) parameter containing *USRID special value.

For local users, there are 4 possible destinations for a subscription:

- Output queue** Identified by the output queue (OUTQ) parameter containing an output queue name. A copy of the spooled file is placed on the output queue when the subscription is processed.
- Printer** Identified by the printer device (PRTDEV) parameter containing a printer name. A copy of the spooled file is placed on the printer's output queue when the subscription is processed.
- Program** Identified by the user process program (USRPRCPGM) parameter containing a program name. The program is called when the subscription is processed.
- Object (PC file)** Identified by the to object PC file (TOOBJ) parameter containing a path. The spooled file is converted into a PC file with the specified name when the subscription is processed.

For network users, there are 2 possible delivery methods. These are:

- SNADS** Identified by the send format (SNDFMT) parameter containing *ALLDATA or *RCDDATA. The spooled file is delivered using IBM i's Send Network Spooled File (SNDNETSPLF) command when the subscription is processed.
- EMAIL** Identified by the send format (SNDFMT) parameter containing *EMAIL. The spooled file is delivered using the Send Spooled Mail (SNDSPMAIL) command when the subscription is processed.

Some subscription parameters apply equally to all subscription destinations. These are:

- Delivery point (DELIVERY)

This is essentially user data for the subscription. It may be used by a report writer to order printing depending on the print options (PRTOPT) specified when the report writer is started, but does not otherwise alter processing of the subscription.

- Start date (STRDATE)

Specifies the date the subscription becomes effective. If the date on which a spooled file is processed falls before this date, the report writer does not deliver the subscription.

- End date (ENDDATE)

Specifies the date the subscription ends. If the date on which a spooled file is processed falls after this date, the report writer does not deliver the subscription.

- Hold (HOLD)

Specifies that the subscription is held at the time it is added. Report writers do not deliver held subscriptions.

- Report filter (RPTFTR)

Specifies the report filter used to select pages for delivery to the subscription's destination.

- Omit zero page delivery (OMITZERO)

For subscriptions that specify a report filter, specifies whether or not the subscription is delivered when the filter selects zero pages. For subscriptions without a report filter, it is ignored.

The following table shows the requirements for specifying the different subscription destinations, and the effect of the Form type (FRMTYP), Copies (COPIES), Deliver status (DLVSTS), Send format (SNDFMT), and Transform to perform (TRANSFORM) parameters for each destination:

	U S E R	U S E R I D	O U T Q	P R I N T E R D E V	U S E R P R O C E S S I N G	T O B E J	F R M T Y P	C O P I E S	D L V S T S	S N D F M T	T R A N S F O R M
local outq	R	-	R	-	-	-	Y	Y	Y		
local printer	R	-	-	R	-	-	Y	Y	Y		
local program	R	-	-	-	R	-			Y		
local PC file	R	-	-	-	-	R					1
network SNADS	*	R	-	-	-	-	3	3	3	Y	
network email	*	R	-	-	-	-				Y	2

Where: R = required parameter entry.
 * = must be *USRID special value.
 - = parameter must be *NONE.
 Y = parameter alters outcome.
 = parameter ignored.
 1 = Y if Spool-a-Matic installed otherwise ignored.
 2 = Y if SpoolMail installed otherwise ignored.
 3 = Y if SNDFMT(*ALLDATA).

The following are examples of adding subscriptions for each destination:

- Local user - output queue

```
ADDRPTSUB    USER (QSYSOPR)  OUTQ (QPRINT)
```

- Local user - printer

```
ADDRPTSUB      USER(QSYSOPR)  OUTQ(*DEV)  PRTDEV(PRT01)
```

- Local user - program

```
ADDRPTSUB      USER(QSYSOPR)  OUTQ(*NONE)
                USRPRCPGM(RMCLNOTIFY)
```

- Local user - PC file

```
ADDRPTSUB      USER(QSYSOPR)  OUTQ(*NONE)
                TOOBJ('/REPORTS/REPORT1.PDF')
                TRANSFORM(*PDFLETTER)
```

- Network user - SNADS

```
ADDRPTSUB      USER(*USRID)  USRID(JOHN SYSTEM2)  OUTQ(*NONE)
                SNDFMT(*ALLDATA)
```

- Network user - email

```
ADDRPTSUB      USER(*USRID)  USRID(JOHN SYSTEM2)  OUTQ(*NONE)
                SNDFMT(*EMAIL)  TRANSFORM(*PDFLETTER)
```

Report Writer Construction Notes

A report writer takes spooled files from an output queue, determines which report each represents and distributes them based on the information contained in the report and its subscriptions. Depending on parameter values specified in the various commands, reports may be distributed to the destination specified when the report writer is started. For a complete list of parameters and their defaults, see the Start Report Writer (STRRPTWTR) command.

There are three basic internal constructions used when starting a report writer. These are "output queue to output queue", "output queue to printer", and "output queue to *NULL printer. The software determines which to use based on how the printer device name is specified on the DEV parameter.

Output queue to output queue:

This construction is used when DEV(*NONE) is specified on the Start Report Writer (STRRPTWTR) command. No printer device is processed. The destination of the report writer is the output queue specified on the default destination queue (DFTOUTQ) parameter. This output queue may or may not be the source queue to another writer. Either way, generation of report separators is handled outside the current report writer.

The output queue to output queue construction is used when distribution information has been entered and the task of the report writer is largely to distribute spooled files to the specified destinations. The default destination output queue then serves largely as a catch basin for routing problems and spooled files that end up in it aren't usually printed.

Figure: Report Writer Output Queue To Output Queue Construction

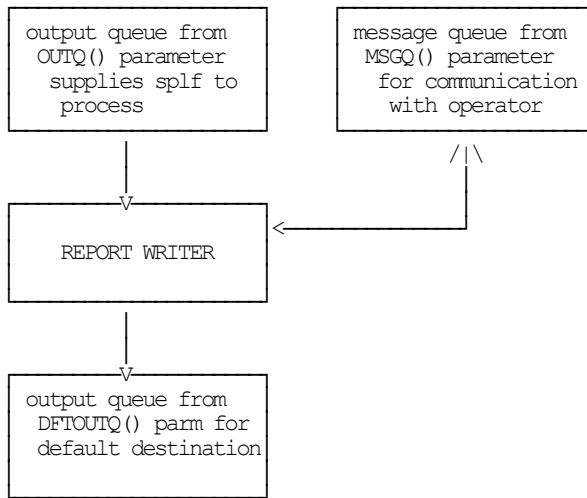

Output queue to printer:

This construction is used when a printer device name or *RMT is specified on the DEV parameter of the Start Report Writer (STRRPTWTR) command. The destination of the report writer is a "hidden" output queue used by Report Manager to feed spooled files to the printer device.

The output queue is hidden in that it is created by the writer with a name known only to it. An IBM i printer writer or remote writer is started between the printer device and the hidden output queue.

The hidden output queue is required to prevent other jobs from creating spooled files on the output queue after the report writer has created a custom file separator but before the associated spooled file is moved to the output queue. If this were allowed to occur the printing of the separator for report "A" could be followed by the printing of Report "B".

Messages generated by the printer writer or remote writer are filtered and interpreted by the report writer before being passed to the report writer's message queue for action.

The "hidden" output queue also serves as the default destination when *PRINT is specified on the DFTOUTQ parameter.

The output queue to printer method is used by installations that have not had a chance to document report distribution or would just like large separators to print on the printer.

Figure: Report Writer Output Queue To Printer Construction

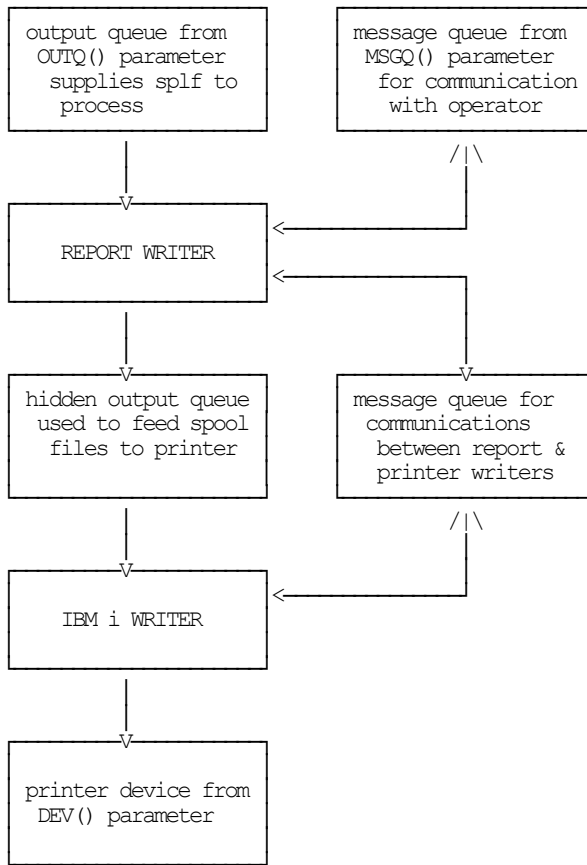

Output queue to *NULL printer:

This construction is used when DEV(*NULL) is specified on the Start Report Writer (STRRPTWTR) command. No printer device is processed but a *NULL printer device emulator is substituted in place of a printer. The destination of the report writer is a "hidden" output queue used by Report Manager to feed spooled files to the *NULL printer device.

The output queue is hidden in that it is created by the writer with a name known only to it. The *NULL printer moves spooled files and separator pages from the hidden output queue to the output queue specified on the default destination queue (DFTOUTQ) parameter. This output queue may or may not be the source queue to another writer.

With this construction, report separators are generated as if the report writer was driving a printer device. This is useful for several reasons. Testing of reports and subscriptions can be performed without printing paper. Also, *NULL printers can be used to generate separators for microfiche and optical storage applications.

Figure: Report Writer Output Queue To *NULL Printer Construction

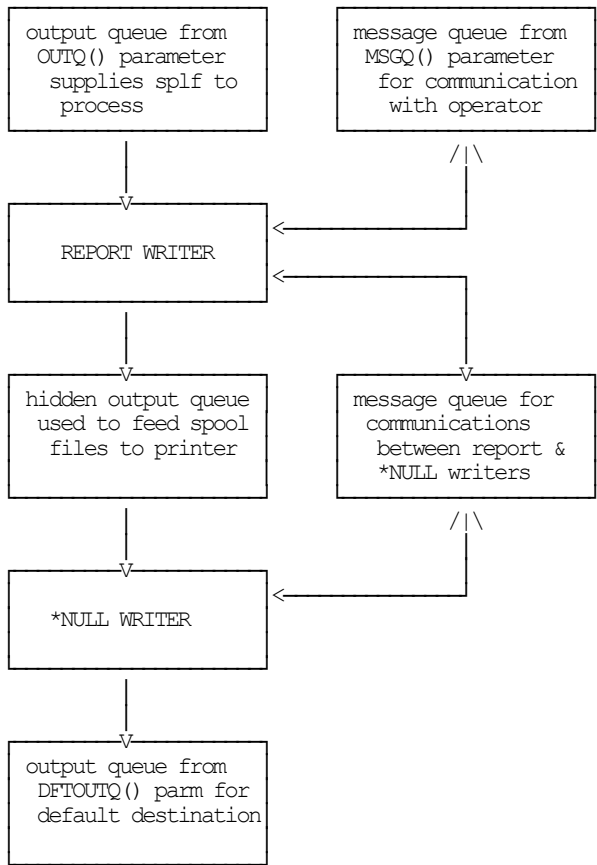

Summary

In all cases, a spooled file can be routed out of the diagram if attributes entered on the report or its subscriptions require delivery to some other destination.

Figure: Report Writer Function Summary

Function	DEV() Parameter Value			
	printer	*RMT	*NONE	*NULL
Generate separators	*YES	*YES	*NO	*YES
Print options affect order	*YES	*YES	*NO	*YES
Print paper	*YES	*YES	*NO	*NO
Optimize affects order	*YES	*YES	*NO	*NO
DFTOUTQ(*PRINT) allowed	*YES	*YES	*NO	*NO
Archives when requested	*YES	*YES	*YES	*YES

Report Writer File Selection Processing

In order to properly distribute a spooled file a report writer must determine which report it is an instance of. This is the spooled file selection process. When a spooled file becomes ready on an output queue the report writer retrieves its attributes. These are compared to the selection masks entered on the Create Report (CRTRPT) command for each report in the libraries in the report library list of the report writer until a match is found. The search is similar to the logic used by IBM i data base to process select/omit criteria for a logical file. The spooled file's attributes are compared to the first selection mask. If it matches the specifications of the mask it is identified as that report. If it does not match, the search continues with the second selection mask.

In the majority of cases the selection masks will uniquely identify a report's spooled files. In other cases, a spooled file may satisfy more than one selection mask. In this case, the order of libraries in the report library list and the order in which selection masks are processed within libraries become important. The Create Report (CRTRPT) command provides a selection processing sequence (SELECTSEQ) parameter which is used to control the order of processing selection masks within libraries. All sequence 0001 masks are processed before any 0002 masks are processed, and so on. As an illustration of the selection process and how it can be used, consider these example reports:

Figure: Selection Sequence

Report name	INV320	PGMTEST
Text	Inventory by loc	Pgm test output
Select on Pgm name. .	INV320	*ALL
Select on Outq . . .	*ALL	DEVDEPT
Select sequence . . .	5000	2000
etc.	etc.	etc.

When test output from the INV320 program is placed on the development department's output queue (DEVDEPT) it could satisfy either of the selection masks specified above. But since PGMTEST's mask has a lower selection sequence it is satisfied first and the spooled file is distributed according to the instructions for "Pgm test output".

Report Writer Page Separator Printing

A separator program is a program that is given control by a report writer to generate separator pages to be printed between spooled files.

Report Manager is shipped with default programs to create page separators. Additionally, a user written program can be specified on the Start Report Writer (STRRPTWTR) command to create page separators.

As a report writer prepares to move a spooled file to a printer device for printing it first calls the separator program. The separator program is responsible for creating a spooled file containing the desired separator information. A spooled file is created when a program opens, writes to and closes a printer device file.

Report writers pass 3 parameters to separator programs; a spooled file attribute record, a log entry record, and a writer control record:

spooled-file-attribute-record The attribute record contains specific information about the spooled file to process. The format of the record is identical to format SPLA0200 returned by system interface program QUSRSPLA. For the layout of this record and a complete discussion of its content see the *Programming > Application programming interfaces > QUSRSPLA - Retrieve Spooled File Attributes* topic in the IBM i Information Center at <http://publib.boulder.ibm.com/series/>.

Note: The output queue name and library in this record are those that should be used by the separator program to receive the separator pages.

log-entry-record The log entry record contains report information from the report distribution log. The format of the record is identical to that of RMEVTR in file RMEVT. For the layout of this record use the Display File Field Description (DSPFFD) command.

writer-control-record The writer control record contains information from the Start Report Writer (STRRPTWTR) command that started the report writer. The format of the record is identical to that of RMWTRR in file RMWTR. For the layout of this record use the Display File Field Description (DSPFFD) command.

Any escape messages received by the report writer from the separator program are added to the report distribution log.

Report Writer Spooled File Limit And Writer Restart

The Spooled file count limit parameter determines the number of spooled files a report writer can create before the writer starts looking for an opportunity to restart the job. Report writers create spooled files when they create separator pages and when they replicate spooled files. IBM i stores information about each spooled file created by a job as part of that job. As the number of spooled files increases, so does the size of several internal job structures.

Left unbounded, the size growth can degrade job performance, and ultimately affect machine performance. After a report writer has created the number of spooled files specified by this parameter, it uses the next idle period to submit a new copy of itself, resetting the spooled file count to zero. In this way report writers can run indefinitely. Since the report writer waits for the first idle period to resubmit itself, the actual number of spooled files in the writer job can exceed the limit set by this parameter.

During the restart operation, the active writer job submits a new copy of itself, registers the job/user/number of the new copy in the writer control space, zeros the spooled file count in the writer control space, and ends. The job queue to which the new copy is submitted is assumed to be released.

The user who started the report writer receives a message each time the active writer job ends.

IBM i Output Queue Selection Logic

The algorithm used by IBM i to determine which output queue a spooled file should be placed on is quite intricate. The following information is taken from *iSeries Printer Device Programming SC41-5713*.

When a spooled file is opened, IBM i looks to the printer file, job description, user profile, display device, and the printer device system value in order to determine which output queue to place it on. The create commands with the default and other values for pertinent parameters are:

```

CRTPRTF      OUTQ(*JOB *DEV or outq-name)
              DEV(*JOB *SYSVAL or printer-device)
CRTJOB      OUTQ(*USRPRF *DEV *WRKSTN or outq-name)
              PRTDEV(*USRPRF *SYSVAL *WRKSTN or
              printer-device)
CRTUSRPRF    OUTQ(*WRKSTN *DEV or outq-name)
              PRTDEV(*WRKSTN *SYSVAL or printer-device)
CRTDEVDSP    OUTQ(*DEV or outq-name)
              PRTDEV(*SYSVAL or printer-device)
QPRTDEV      system value is shipped as PRT01 on most systems

```

Assuming that the defaults were taken on all create command parameters, when a spooled file is opened the printer file specifies that the output queue name is taken from the job. The job description specifies that the output queue name is taken from the user profile. The user profile specifies that the output queue name is taken from the workstation. The display device specifies that the printer device parameter of the printer file is used to determine the destination of the spooled file. The printer file specifies that the printer device is taken from the job. The job description specifies that the printer device is taken from the user profile. The user profile specifies that the printer device is taken from the workstation. The display device specifies that the printer device is taken from the system value QPRTDEV. The output queue with the same name as the printer device specified in the system value is used.

Report Manager Output Queue Selection Logic

Report Manager provides output queue selection logic that is consistent with and extends IBM i output queue selection logic. When a spooled file is processed, Report Manager looks to the report subscription, report, and report writer to determine which output queue to place it on. Additionally, Report Manager may look to the printer file, job description, user profile, display device, and the printer device system value if called on to perform IBM i selection logic. The create and start commands with the default and other values for pertinent parameters are:

```

ADDRPTSUB    OUTQ(*RPT *WTR *DEV *USRPRF *JOB *WRKSTN or
              outq-name)
              PRTDEV(*NONE *SYSVAL *USRPRF *WRKSTN or
              printer-device)
CRTRPT      OUTQ(*WTR *DEV *USRPRF *JOB *WRKSTN or
              outq-name)
              PRTDEV(*NONE *SYSVAL *USRPRF *WRKSTN or
              printer-device)
STRRPTWTR    DEV(printer-device *SYSVAL or *NONE)
              DFTOUTQ(*PRINT or outq-name)

```

Assuming that the defaults were taken on all create and start command parameters, when a spooled file is processed the subscription specifies that the output queue is taken from the report. The report specifies that the output queue name is taken from the report writer. The report writer defaults to the printer device it is processing if there is one or to the default output queue if there is no printer device.

The values other than *RPT and *WTR for the most part have their usual IBM i meanings and are processed accordingly. In IBM i *DEV has two meanings, one for display devices and the other on the rest of the commands. On a display device *DEV references the DEV parameter of the printer device file in question and not the PRTDEV parameter of the display device itself. Call this a long reference. On the other commands, *DEV references the PRTDEV parameter of the command in question. Call this a short reference. Report Manager implements the *DEV as a short reference.

For details of IBM i parameter processing see *iSeries Printer Device Programming SC41-5713*.

Report Writer Redelivery Logic

Redelivery occurs when a report writer encounters a spooled file delivered to it by another report writer. The second report writer performs selection processing for the spooled file. If it identifies the same report name as the first report writer or if it results in report *NONE, the determination of the first report writer is taken at face value. If however the second report writer selects a different report name for the spooled file, it voids the delivery information created by the first report writer and calculates new delivery information. This logic provides several capabilities for system set up.

Since a report writer started with RPTLIBL(*NONE) will always select report name *NONE, the functions of distribution and printing can be split between two or more report writers. The first report writer is started without a printer device and performs only distribution processing. Additional report writers are started for each printer device with RPTLIBL(*NONE) and perform only printing functions for that device.

Alternately, redelivery can be used to establish a hierarchy of report writers. A system level report writer can be used to make a first cut at delivering spooled files by forwarding them to departmental report writers based on the first two letters of program name for example. The departmental report writers can then refine delivery by processing the spooled files against a complete set of reports containing the final distributions within the department.

In all cases, report writers will not void or alter distributions made to any output queue other than the one they are processing. This allows the two methods outlined above to be intermixed.

Archive Naming

Archives can be given a name when created using the Archive Spooled File (ARCSPLF) command. Alternately, the command can generate a unique archive name based on the spooled file being archived. Report writers always create archives with generated names.

A generated archive name is uniquely constructed from the job number of the job that originally created the spooled file combined with the spooled file number within the job. The first digit of the combined numbers is mapped into the alphabet (0=A, 1=B, ...) to produce a valid system name.

Very large spooled files -- those in excess of 16 megabytes or approximately 5000 pages of line data -- are stored in multiple user spaces. The names of the additional spaces are created by mapping successive digits of the generated name into the alphabet, working from right to left. This is true even if the first space is given a specific name.

Archive Restore Program

An archive restore program is called when the Retrieve Spooled File (RTVSPLF) command cannot locate a spooled file's archive. The program is responsible for restoring the archive from offline media.

Use the Change Report Manager Defaults (CHGRM1DFT) command to specify the name of an archive restore program for the system.

When the Retrieve Spooled File (RTVSPLF) command calls the archive restore program, it passes 2 parameters:

- Restore program results** Character variable of length 10. The restore program changes this variable to one of the following values to inform the Retrieve Spooled File (RTVSPLF) command of the results of restore processing:
- *RESTORED** The requested archive has been successfully restored and is available for processing.
 - *DELAYED** The requested archive was not immediately restored but will be restored at a future time. Use this value when the restore program submits a batch job to process the restore request. Message RDM2131 is sent to the user.
 - *CANCELED** The requested archive was not restored. Use this value when the user cancels the restore program during prompting or confirmation processing. Message RDM2132 is sent to the user.
 - *UNKNOWN** The requested archive was not restored. Use this value when the restore program does not recognize the archive name and does not know how to restore it. Message RDM2133 is sent to the user.
 - *FAILED** The requested archive was not restored. Use this value when the restore program encounters an unrecoverable problem while restoring the archive. Message RDM2129 is sent to the user.
- Archive name and library** Character variable of length 20. The variable contains the name and library of the archive to restore. The name of the archive is contained in positions 1-10. The name of the archive library is contained in positions 11-20.

The following is a Control Language program fragment for an archive restore program:

```
PGM          PARM(&RESULTS &ARCNAMLIB)
DCL          VAR(&ARCNAMLIB) TYPE(*CHAR) LEN(20)
DCL          VAR(&ARCNAM) TYPE(*CHAR) LEN(10)
DCL          VAR(&ARCLIB) TYPE(*CHAR) LEN(10)
DCL          VAR(&RESULTS) TYPE(*CHAR) LEN(10)
CHGVAR      VAR(&ARCNAM) VALUE(%SST(&ARCNAMLIB 1 10))
CHGVAR      VAR(&ARCLIB) VALUE(%SST(&ARCNAMLIB 11 10))
.
      (additional commands to restore the archive)
.
CHGVAR      VAR(&RESULTS) VALUE(*RESTORED)
ENDPGM
```

Log Purge Program

A log purge program is a program that is given control by a report writer during the daily report distribution log purge processing.

Use the Change Report Manager Defaults (CHGRM1DFT) command to specify the name of a log purge program for the system.

As a report writer purges the report distribution log based on the log size parameter, it deletes data base records. Before it deletes each record from file RMEVT it first calls the log purge program. The log purge program may perform additional clean up work based on the log data that is about to be purged.

Report writers pass 2 parameters to the log purge program; the log entry record, and a writer control record:

- log-entry-record** The log entry record contains report information from the report distribution log. The format of the record is identical to that of RMEVTR in file RMEVT. For the layout of this record use the Display File Field Description (DSPFFD) command.
- writer-control-record** The writer control record contains information from the Start Report Writer (STRRPTWTR) command that started the report writer. The format of the record is identical to that of RMWTRR in file RMWTR. For the layout of this record use the Display File Field Description (DSPFFD) command.

If the log purge program fails during purge processing, a message is sent to the report writer's message queue. Only one message is sent during the day's purge processing even if the program fails on more than one call.

Chapter 9 Security

What's In This Chapter

This chapter covers security issues related to Report Manager. The chapter:

- Describes the API authority granted during installation.
- Describes granting *SPLCTL special authority to operators.
- Describes how to remove authority adoption from the software.
- Describes how to control the user profile that report writers run under.

API Authority Granted During Installation

The first time Report Manager is installed on a system, public authority *USE is granted to the IBM i supplied spooling APIs. These are QSPOPNP, QSPCRTSP, QSPGETSP, QSPPUTSP and QSPCLOSP. The APIs are used by Report Manager to open, create, write, read and close spooled files. This is required to perform the product's functions.

Security restrictions and authority requirements pertaining to spooled files and output queues remain in effect and are enforced by IBM i during use of the APIs. However, if you are operating a highly secured environment you may wish to review and revise the authority granted during installation.

No authority is granted during installation if Report Manager exists on the system. This prevents new releases from altering changes made after the initial installation.

Granting *SPLCTL Special Authority To Operators

The first time Report Manager is installed on a system, *SPLCTL special authority is granted to the QSYSOPR user profile. This authority insures that report writers started by QSYSOPR can perform all processing required to deliver spooled files.

You should grant *SPLCTL special authority to any other user profiles that will start report writers.

If you are operating a highly secured environment you may wish to review and revise the special authority granted during installation.

If the user profile that starts a report writer does not have *SPLCTL special authority, attempts to process spooled files for delivery or printing may fail. The errors will be logged to the report distribution log and the spooled file will be changed to SAVE(*YES).

No authority is granted during installation if Report Manager exists on the system. This prevents new releases from altering changes made after the initial installation.

Removing Authority Adoption

Report Manager contains 2 programs that adopt the authority of the security officer (QSECOFR). Program RMCL031 uses the authority to attach a data queue to the output queue when a report writer is started. Program RMCL032 uses the authority to detach the same data queue from the output queue when a report writer is ended. Both programs use the Change Output Queue (CHGOUTQ) command and both are running under the user profile that started the report writer.

You can remove the authority adoption requirement of these programs by providing authority to the user profiles that will be starting or ending report writers. You must provide enough authority to perform a Change Output Queue (CHGOUTQ) command on the output queues that will be used with Report Manager.

One method that provides authority is to grant *CHANGE and *OBJMGT authority to a user profile for an output queue and to change the output queue's "authority to check" (AUTCHK) parameter to *DTAAUT. To use this method on output queue "my_outq" and user profile "my_profile" enter the following commands:

```

GRTOBJAUT  OBJ(my_outq)  OBJTYPE(*OUTQ)  USER(my_profile)
            AUT(*CHANGE)
GRTOBJAUT  OBJ(my_outq)  OBJTYPE(*OUTQ)  USER(my_profile)
            AUT(*OBJMGT)
CHGOUTQ    OUTQ(my_outq)  AUTCHK(*DTAAUT)
CHGPGM     PGM(RPTMGR/RMCL031)  USRPRF(*USER)
CHGPGM     PGM(RPTMGR/RMCL032)  USRPRF(*USER)

```

After the commands are run, "my_profile" will be able to start a report writer against "my_outq" (but no other), and the software will not adopt security officer authority. This method may introduce security exposures in your system and should be checked for applicability to your installation.

Report Writer User Profile

When a report writer is started using the Start Report Writer (STRRPTWTR) command, one or more batch jobs are submitted to the QSPL job queue for processing. Job description RMRPTWTR governs how these jobs are submitted and the user profile under which they run. When RMRPTWTR's user profile parameter specifies *RQD, the submitted jobs run under the user profile of the user executing the Start Report Writer (STRRPTWTR) command. When a user profile is specified on job description RMRPTWTR the submitted jobs run under that profile.

The RMRPTWTR job description is shipped with user profile *RQD specified. Thus report writers run under the authority of the user profiles that start them. You may wish to have all report writers run under a single user profile in order to simplify authority management.

To change the user profile specified on job description RMRPTWTR to "my_profile" enter the following command:

```
CHGJOB    JOBD(RMRPTWTR)  USER(my_profile)
```

All report writers that are started after the command runs will operate under profile "my_profile".

Chapter 10 Trouble-Shooting

What's In This Chapter

This chapter provides information and procedures useful for finding and correcting Report Manager problems. The chapter:

- Describes general report writer trouble-shooting.
- Describes how to isolate report selection problems.
- Describes miscellaneous report writer symptoms and their causes.
- Describes additional tips and ideas for using Report Manager.
- Describes software installation problems.
- Describes general mail delivery problems.
- Describes MSF specific delivery problems.
- Describes SMTP specific delivery problems.
- Describes how to create a spool save file.
- Describes how to email a spool save file.

General Report Writer Trouble-Shooting

When you encounter results that are different than those expected, the single best source of information for problem isolation is the report distribution log. The log contains the details of processing performed by report writers and information concerning errors they encountered. To use the report distribution log:

- From a command line enter DSPRPTLOG
- Press F4
- Enter the time period in which the problem occurred
- Press the ENTER key

Error information is contained in the entries with type *MESSAGE.

You may be able to find information on more severe problems such as software failures by changing Report Manager's job description to generate job logs for report writers. To have report writers generate job logs enter the following:

```
CHGJOB  JOB (RPTMGR/RMRPTWTR)  LOG (4 0 *SECLVL)
```

End the report writer immediately after the problem occurs since report writers clear information from the message queues that make up the job log as part of their normal idle state cleanup routine.

Report Selection Problem Isolation Procedure

If after creating reports, starting a report writer and processing spooled files you are not getting the results you expect or if you know that the report writer is selecting the wrong report name for a spooled file, use the following procedure to isolate problems with a report writer's report selection processing.

Report selection processing problem isolation procedure:

- Review the report distribution log for a specific spooled file

Use the Display Report Log (DSPRPTLOG) command to display the report log. Locate a recently processed entry with type *SPLF. Look under the **Report** column heading for the name of the report that the report writer associated with the spooled file.

- If report name *NONE is associated with the spooled file the report writer could not locate reports to compare with the spooled file or when the report writer compared the spooled file, none of the reports selected it.

Use the Work with Report Writer (WRKRPTWTR) command to view the report writer. Locate the "Report library list . ." data item.

- If the library containing your reports does not appear in the report library list, this is the problem.
 - End the report writer using the End Report Writer (ENDRPTWTR) command.
 - Start report writer with the Start Report Writer (STRRPTWTR) command and specify the name of the library containing the reports on the report library list (RPTLIBL) parameter.
 - Retry spooled file processing (end of procedure).
- Else, the report library list is correct and the problem lies in the comparison of spooled file attributes to report selection criteria.
 - Print the attributes of the spooled file using the Work with Spooled File Attr (WRKSPLFA) command or display them using option 8 from the Work with Spooled Files (WRKSPLF) panel.
 - Print the definition of the report using the Work with Reports (WRKRPT) command.
 - Compare the selection criteria of the report with the attributes of the spooled file item by item to locate the mismatch between the selection criteria and the attributes.
 - Correct report's selection criteria using the Change Report (CHGRPT) command.
 - Retry spooled file processing (end of procedure).

Note: Special selection values *ALL, *NOMIN and *NOMAX match all attribute values. You must display the device file in order to determine print text for the spooled file.

- Else, a report name is associated with the spooled file.
 - Check report name.
 - If the wrong report name is associated with spooled file.
 - Print the attributes of the spooled file using the Work with Spooled File Attr (WRKSPLFA) command or display them using option 8 from the Work with Spooled Files (WRKSPLF) panel.
 - Print a report library list selection parameter listing using the Display Report Selection List (DSPRPTSLTL) command specifying the report library list (RPTLIBL) parameter as specified on the Start Report Writer (STRRPTWTR) command.
 - Starting at the top of the list, compare the spooled file's attributes to each set of selection criteria in turn until the spooled file is "selected". Review the selection criteria of the intended report.
 - Make changes to selection criteria of the reports as required using the Change Report (CHGRPT) command.
 - Adjust the selection sequences of the reports as required using the Change Report (CHGRPT) command.
 - Retry spooled file processing (end of procedure).
 - Else, the correct report name is associated with spooled file.
 - Problem does not lie in selection process (end of procedure).

Miscellaneous Report Writer Symptoms And Their Causes

The following list contains other commonly encountered problems and probable causes or possible corrective actions.

- Spooled files are held and not delivered.

Symptom	Report writer holds spooled files.
Cause	Spooled files are selected by a report that has been held. The report distribution log will show a status of *HELD .
Solution	Release the report using the Release Report (RLSRPT) command. Release the spooled files using the Release Spooled File (RLSSPLF) command.

- More copies are delivered than expected.

Symptom	Report writer delivers an extra copy for subscriber *NONE
Cause	Distributions to subscriber *NONE are controlled by a report's COPIES parameter.
Solution	Use the Change Report (CHGRPT) command to change the COPIES parameter to the special value *RPTSUB . This specifies that distributions for the report are governed entirely by the report's subscriptions.

- Program name is blank.

Symptom	The name of the program that opened a spooled file is shown as blank on the Work with Spooled File Attr (WRKSPLFA) panel. As a consequence, selection processing based on program name fails.
Cause	Programs created by some utilities such as Query for IBM i do not log the program name as an attribute of the spooled files they create.
Solution	Use OVRPRTF to give the spooled file identifiable attributes such as SPLFNAME() or USRDTA(). Then use other report selection criteria for spooled file name or user data to identify spooled files.

Additional Tips And Ideas

The following list contains additional tips and ideas for using Report Manager's features.

- Holding unmanaged spooled files instead of printing

When a report writer is started with the default destination output queue of *PRINT, unmanaged spooled files are passed through to the printer. You can get the report writer to hold all unmanaged spooled files by creating the following report in your report library:

```
CRTRPT  RPT(my_library/UNMANAGED) SELECT(*ALL)
        SELECTSEQ(9999)  HOLD(*YES)
```

The report will select any and all spooled files, but since its selection sequence is the highest possible value, it will always be evaluated after all other reports in the library. If a spooled file is not selected by any of the other reports (is unmanaged) it is selected by this report which is held, causing the report writer to hold the spooled file.

- Report Manager Defined Options For PDM Object Panel

The library RPTMGR includes file RMPDMOPT containing PDM user-defined options for use with Report Manager created objects. The options allow you to perform common tasks from the Work with Objects Using PDM (WRKOBJPDM) panel. For more information on user-defined options and how to copy them, see: *Application Programming Development Manager User's Guide SC09-2133-02*.

- Filter name as user data

When a report writer creates a spooled file using a filter, it will place the name of the filter in the user data of the new spooled file if the user data of the original is blank. The user data of the original is governed by the printer device file used to create it. To change a printer device file to create spooled files with blank user data, enter the following:

```
CHGPRTF FILE(my_library/my_file) USRDTA(' ')
```

- Examples And Source Code

The library RPTMGR includes file RMSOURCE containing examples and source code that provides additional ideas for using Report Manager.

- Path Name Too Long for TOOBJ() Parameter

A report subscription's Object (PC file) (TOOBJ) parameter is limited to 64 positions. If this is too short for your usage, there are a couple of work arounds:

- Create a symoblic link with a short name.

```
ADDLNK
OBJ('/long_directory_name/another_long_directory+
_name/the_intended_directory_for_report_subscriptions')
NEWLNK('/rptwrk') LNKTYPE(*SYMBOLIC)
```

This shortens the parameter to:

```
TOOBJ('/rptwrk/my_file_name.txt')
```

- Run report writers under a profile with a home directory

Report writer's run under the user profile specified on the RMRPTWTR job description. As delivered, the job description has USER(*RQD) i.e. the profile running the STRRPTWTR command. Create a user profile which specifies a convenient home directory:

```
CRTUSRPRF ...
HOMEDIR('/long_directory_name/another_long_directory+
_name/the_intended_directory_for_report_subscriptions')
```

Change job description RMRPTWTR to specify the newly created user profile.

This shortens the parameter to:

```
TOOBJ('my_file_name.txt')
```

Note: You must end and restart report writers to see the affect of changes to job description RMRPTWTR.

Software Installation Problems

This section describes problems, causes, and solutions specific to software installation.

- Installation Generates "Directory not registered. (C G)"

Symptom	During installation inquiry message id CPA3DE4 "Directory not registered. (C G)" is issued.
Cause	IBM i has lost the relationship between the product and the directory and hence the message.
Solution	You can safely take a "G" to this message. You will receive the message 3 times.

- Installation Fails

Symptom	Installation fails and diagnostic message id CPF9898 "Unable to clear old release. Is the software being used?" appears in the job log. Or, when the installation verification option is run, verification fails with diagnostic message id CPD0C2E appearing in the job log.
Cause	This usually arises from attempting to install a new release over an old release while objects in the old release are in use.
Solution	End the jobs that are holding locks on (using) objects from the old release and perform the installation again.

- Installation Fails or Installation Verification Fails

Symptom	Installation or installation verification fails and messages in the job log do not help in recovering.
Cause	The software is not installed correctly or the installation is damaged. This can be caused for a variety of reasons including renaming of libraries, directories, or objects that make up the product.
Solution	Get the system to a stable consistent state by completely removing the product then re-installing it by performing the following: <ol style="list-style-type: none"> 1. Delete the licensed program by running: <pre>DLTLICPGM LICPGM(2A55RM1) RLS(*ALL) OPTION(*ALL)</pre> <p>Note: It is okay if this fails with diagnostic CPD3D91 "Product 2A55RM1 option *ALL release *ALL not installed."</p> 2. Delete the product's library by running: <pre>DLTLIB LIB(RPTMGR)</pre> <p>Note: It is okay if this fails with escape CPF2110 "Library RPTMGR not found."</p> 3. Delete the product's directories by running: <pre>RMVDIR DIR('/Gumbo/ProdData/2A55RM1/doc') SUBTREE(*ALL) RMVDIR DIR('/Gumbo/ProdData/2A55RM1/tmp') SUBTREE(*ALL) RMVDIR DIR('/Gumbo/ProdData/2A55RM1') SUBTREE(*ALL)</pre> <p>Note: It is okay if these fail with escape CPFA0A9 "Object not found. ...". But if any of these fail because a directory is not empty, delete the contents using WRKLNK.</p> <p>If there are no other GUMBO products installed:</p> <pre>RMVDIR DIR('/Gumbo/ProdData') RMVDIR DIR('/Gumbo')</pre> 4. Rebuild IBM i's internal licensed program information by running: <pre>CALL PGM(QSYS/QSZRECOV)</pre> <p>Note: This takes several minutes depending on machine size.</p> 5. Install the product according to the instructions in the Installation chapter. 6. Enter your authorization code.

General Mail Delivery Problems

This section describes common problems, causes, and solutions for general mail delivery problems. They are listed roughly in the order in which you should proceed. During general mail delivery trouble shooting you should send tests to yourself. Once this works properly, you can move on.

The bulk of the entries in this section are derived from trouble shooting performed by or with customers and in some sense presume that you have an "average" installation. The "average" installation is System i connected to a LAN with the post office (a.k.a. mailhub) on a LAN attached PC running Exchange or Domino, with a connection to the internet at large. At the "average" installation this is the first application to generate email from the System i. Some of the entries in this section may not apply to your situation.

- System Mailhub Configuration Is Unknown

Symptom The name of the configured mailhub is unknown.
Cause You did not originally configure the system for email delivery.
Solution Prompt the CHGSMTPA command and inspect the Forwarding mailhub server (FWDHUBSVR) parameter. If the value is *NONE, a mailhub is not configured. Otherwise, the name of the mailhub is shown.

- Source Of Problem Is Unknown

Symptom The send operation runs to completion but no mail arrives.
Cause The problem may be with the mailhub or with IBM i, but the source is unknown.
Solution Run PINGMAIL to generate a test message to your email address and directly deliver it to the mailhub by passing IBM i's mail machinery entirely:

Note: Substitute the name of your mailhub for the value "mailhub_server" and substitute your email address for the value "you@domain.com" in the following command.

```
PINGMAIL RMTSYS (mailhub_server)
          SMTPNAME (you@domain.com)
```

If you receive the test message, the mailhub is working correctly and an IBM i issue is indicated. In particular, if the rest of the entries in this section do not correct the problem, you may have a DNS issue.

If you do not receive the test message then there is a problem with the mailhub. You may be able to get an indication of the problem by reviewing the SMTP conversation, which appears in your joblog. Run DSPJOBLOG, press F10 and page back for details.

- IBM i Servers Are Down

Symptom The send operation runs to completion but no mail arrives.
Cause The IBM i servers responsible for mail delivery may be down, particularly if the System i has been IPLed.
Solution Rerun VFYLOCAL to verify that all local servers are up and running:
 VFYLOCAL SETUP (*NO)

If local verification fails, run:
 VFYLOCAL SETUP (*YES)

- Mailhub Is Not Processing Mail

Symptom The send operation runs to completion but no mail arrives.
Cause The mailhub responsible for mail delivery may be down, or not accepting mail from IBM i.
Solution Rerun VFYMAILHUB to verify that the mailhub is up and running:
 VFYMAILHUB SETUP (*NO)

If mailhub verification fails, run:
 VFYMAILHUB SETUP (*YES)

- Mailhub Refuses Mail with "Funny" Originator Address

Symptom The send operation runs to completion but no mail arrives. Or mail arrives for some users but not all users, for example for all but AOL accounts.
Cause An email address is not assigned to your directory entry and the mailhub does not like the "funny" address IBM i generates for the originator's address.

Solution Assign your email address to your system distribution directory entry: (assume for this example that your "User ID and Address" are "BILLG S1234567" and you "real" email address is "billg@acme.com")

```
CHGDIRE USRID(BILLG S1234567)
        MSFSRVLVL(*SYSMS) PREFADR(*SMTP)
        USRDFNFLD((SMTPAUSRID SMTP 'billg')
                  (SMTPDMN SMTP 'acme.com'))
```

Note: If you are a local Domino for IBM i user substitute MSFSRVLVL(*DOMINO) for MSFSRVLVL(*SYSMS).

- SMTP Servers Require Reinitialization

Symptom The send operation runs to completion but no mail arrives.

Cause IBM i's SMTP servers may need to reinitialize. This is undocumented but our experience and discussions with IBM i's SMTP architect confirm this.

Solution Reinitialize IBM i's SMTP servers:
INZLOCAL SMTP(*YES) SMTPPURGE(*NO)
MSF(*NO) MSFPURGE(*NO)

- SMTP Servers Are Clogged With Junk

Symptom The send operation runs to completion but no mail arrives.

Cause IBM i's SMTP server may contain dead letters or other junk that it can not deliver. This can be the result of previous attempts to set up mail on the system.

Solution Clean out IBM i's SMTP server:

Note: Only perform this procedure if you are sure there is no valid deliverable mail in the SMTP server.

Note: This procedure should be required at most once per system during initial set up.

```
INZLOCAL SMTP(*YES) SMTPPURGE(*YES)
MSF(*YES) MSFPURGE(*YES)
```

- Mail Server Framework Is Reporting Errors

Symptom The send operation runs to completion but no mail arrives.

Cause IBM i's Mail Server Framework jobs may be unable to process mail and are reporting errors.

Solution Review job logs for the Mail Server Framework jobs:

1. Work with active jobs by running the following command:
WRKACTJOB
2. Page down to the QSYSWRK subsystem.
3. Locate the job or jobs with the name QMSF and repeat the following steps for each job.
4. Display the job by using option 5 and pressing enter.
5. Display the job log by selecting option 10 and pressing enter.
6. Display detailed messages by pressing F10.
7. You should see a job started (CPF1124) and job submitted (CPI1125) message. If there are no other messages, the Mail Server Framework is not reporting errors. (End of procedure).
8. Display detailed information for each additional message by placing your cursor on the message and pressing F1.
9. Take any corrective action specified in the messages.
10. See the MSF Specific Delivery Problems section of this chapter.

- Mail Server Framework Is Ending Abnormally

Symptom The send operation runs to completion but no mail arrives.

Cause IBM i's Mail Server Framework jobs may be unable to process mail and are ending abnormally.

Solution

Review job logs for the Mail Server Framework jobs:

1. Locate job logs for Mail Server Framework jobs that have ended by running the following command:
WRKSPLF SELECT (QMSF)

If there are no spooled output files, the Mail Server Framework is not ending abnormally (end of procedure).

2. Page down to the end of the list of spooled files.
3. Display the date and time of the spooled files by pressing F11. If there are no recent spooled files, the Mail Server Framework is not ending abnormally (end of procedure).
4. For each recent job log repeat the following steps:
5. Display the job log by using option 5 and pressing enter.
6. Review the job log for diagnostic and escape messages.
7. Take any corrective action specified in the messages.
8. See the MSF Specific Delivery Problems section of this chapter.

- SMTP Servers Are Reporting Errors

Symptom

The send operation runs to completion but no mail arrives.

Cause

IBM i's SMTP server jobs may be unable to process mail and are reporting errors.

Solution

Review job logs for the SMTP server jobs:

1. Work with active jobs by running the following command:
WRKACTJOB
2. Page down to the QSYSWRK subsystem.
3. Locate the 4 SMTP server jobs with names that start with QTSMTP*. Repeat the following steps for each job.
4. Display the job by using option 5 and pressing enter.
5. Display the job log by selecting option 10 and pressing enter.
6. Display detailed messages by pressing F10.
7. You should see a job started (CPF1124) and job submitted (CPI1125) message. If there are no other messages, the Mail Server Framework is not reporting errors. (End of procedure).
8. Display detailed information for each additional message by placing your cursor on the message and pressing F1.
9. Take any corrective action specified in the messages.
10. See the SMTP Specific Problems section of this chapter.

- SMTP Servers Are Ending Abnormally

Symptom

The send operation runs to completion but no mail arrives.

Cause

IBM i's SMTP server jobs may be unable to process mail and are ending abnormally.

Solution

Review job logs for the SMTP server jobs:

1. Locate job logs for SMTP server jobs that have ended by running the following command:
WRKSPLF SELECT (QTCP)

If there are no spooled output files, the SMTP server jobs are not ending abnormally (end of procedure).

2. Page down to the end of the list of spooled files.
3. Display the date and time of the spooled files by pressing F11. If there are no recent spooled files, the SMTP server jobs are not ending abnormally (end of procedure).
4. For each recent job log repeat the following steps:
5. Display the job log by using option 5 and pressing enter.
6. Review the job log for diagnostic and escape messages.
7. Take any corrective action specified in the messages.
8. See the SMTP Specific Problems section of this chapter.

MSF Specific Delivery Problems

This section describes problems, causes, and solutions specific to IBM i's Mail Server Framework.

- MSF Job Log Contains QTCPTMM/ATTABOX Messages

Symptom A QMSF job is complaining about a directory such as QTCPTMM/ATTABOX.
Cause IBM i's MSF jobs depend on specific directories in the Integrated File System which are added by installing the TCP/IP Utilities and may have been deleted.
Solution Check the existence of the TCP/IP related directories and reinstall them if they are missing by:

1. Run the WRKLNK command and locate the QTCPTMM directory.
2. Display QTCPTMM's contents using option 5.
3. Verify that subdirectories ATTABOX, ENCODE, MAIL, SMTPBOX and TMP exist.
4. If directories are missing continue with this procedure otherwise end of procedure.
5. Use the DLTLICPGM command to remove the TCP/IP Utilities.
6. Use the RSTLICPGM command to reinstall the TCP/IP Utilities.

- MSF Job Log Contains "System storage threshold exceeded" Message

Symptom A QMSF job complains that "System storage threshold exceeded".
Cause IBM i's MSF jobs stop processing mail when amount of disk space used rises above a set percentage. IBM i ships with this value set to 90%.
Solution Either free disk space by deleting unused items or bump the threshold value with this procedure:

1. Run the STRSST command and select option 3 Work with disk units.
2. Select option 2 Work with disk configuration.
3. Select option 3 Work with ASP threshold.
4. Use 1=Select for the appropriate ASP (usually ASP 1).
5. Press F1=Help to review help for the Change Storage Threshold display.
6. Change the ASP threshold to 95% or a comfortable value for your installation.

SMTP Specific Delivery Problems

This section describes problems, causes, and solutions specific to IBM i's SMTP servers.

- SMTP Retries Set To Zero

Symptom The send operation runs to completion but no mail arrives, or mail arrives for a while then stops until the next IPL.
Cause The mailhub is periodically slow or unavailable and IBM i's SMTP attributes for retries are set too low or set to zero.
Solution Increase the retry values to give the mailhub more chances at fielding the incoming mail:

1. Prompt the CHGSMTPA command.
2. Increase the number of retries for the retries by minute parameter.
3. Increase the number of retries for the retries by day parameter.
4. Press enter.

- Multiple Garbled Email Messages Arrive

Symptom Multiple messages arrive for a send operation and the messages are garbled.
Cause IBM i's SMTP is splitting the messages.
Solution Turn off message splitting entirely by changing the POP attributes:
 CHGPOPA MSGSPLIT (*NOMAX)

- Time On Mail Is Incorrect

Symptom Mail delivers but contains the wrong time.
Cause IBM i's QTIMZON system value is not set.
Solution See Manual Mail Set Up Steps You May Need To Perform section of the Set Up chapter for instructions to correct this value. For related information see the *System management > Time management* topic in the IBM i Information Center at <http://publib.boulder.ibm.com/iseres/>.

Creating a Spool Save File

A save file containing all the information needed to transport and reproduce a spooled file on a **GUMBO** development system can be produced using the Create Spool Save File (CRTSPLSAVF) command. To create a spool save file:

- Determine the identity of the spooled file to be saved. A spooled file's identity consists of the file's name, the name/user/number of the job that created it, and the spooled file's number within the job. You can find this information using option 8 from the Work with Spooled Files (WRKSPLF) or Work with Output Queue (WRKOUTQ) commands among others.
- Determine a library to contain the save file. Typically this is your test library. If you do not have a test library, QGPL can be used.
- Determine a name for the save file. It must be a file name that does not exist in the library determined above.
- Run the Create Spool Save File (CRTSPLSAVF) command entering the information from the preceding steps.

Note: The command allows for a short message to be included in the save file. Use this to describe the reason for the save file and to include contact information such as your name and phone number.



In saving the spooled file the command creates a temporary library. It retrieves the contents and attributes of the spooled file and stores these in a user space. Any resources used (such as page segments or overlays) are duplicated to the temporary library. Data areas containing various system values and the message are placed in the library. After creating the requested save file, the library is saved to it and finally the temporary library is deleted.



Emailing A Spool Save File

Once a spool save file has been created using the Create Spool Save File (CRTSPLSAVF) command you can download it to your PC and email it to **GUMBO** by following these steps:

1.  Insure the FTP server is active by running:



```
STRTCPSVR SERVER(*FTP)
```

2.  Choose Start > Programs > Accessories > Command Prompt to open a command prompt (DOS session).
3.  Create a temporary directory and change to it:

```
md c:\gumbo   
cd c:\gumbo 
```

4.  Open an FTP connection to the System i by substituting your system's host name and running:

```
ftp host_name 
```

5.  Enter a user name and password as prompted.
6.  Change to binary (image) mode by running:

```
binary 
```

7.  Change to library/file/member mode by running:

```
quote site namefmt 0 
```

8. **[PC]** Download the spool save file by running (in this example the save file's name is QGPL/TEST):

```
get qgpl/test [Enter]
```

9. **[PC]** End the ftp session and the command prompt by running:

```
quit [Enter]  
exit [Enter]
```

10. **[PC]** Send email to support@gumbo.com after attaching file c:\gumbo\test.

Include in your email a description of the problem encountered and the command parameter values you were using when it happened.

Chapter 11 Mail Set Up

What's In This Chapter

This chapter provides information on setting up your System i to send email created by Report Manager. If you do not intend to use Report Manager to create email you can skip this chapter entirely. The chapter describes:

- How to select a quick start mail set up procedure.
- Quick start mail set up - Mailhub.
- Quick start mail set up - Direct Delivery.
- How to use the Verify/Set Up Local SMTP (VFYLOCAL) command.
- How to use the Verify/Set Up Mailhub Server (VFYMAILHUB) command.
- Manual mail set up steps you may need to perform.
- Additional mail set up resources.

Selecting The Quick Start Mail Set Up Procedure

Report Manager creates email by constructing a MIME formatted message and passing it to IBM i for processing and delivery. If your System i is already configured for email delivery, no additional set up is needed and you can skip this chapter. If Report Manager is the first application on the System i to generate email for delivery, there are IBM i configuration changes you must perform. Report Manager includes a Mail Verification And Set Up menu (GO RPTMGR/MAILSETUP) that provides tools to help you make them.

However, the scope of this chapter is limited. If any of the following apply to your installation, proceed directly to the Additional Mail Set Up Resources section for references to help in configuring IBM i:

- Domino for IBM i is installed on the system.
- Multiple TCP/IP interfaces (other than *LOOPBACK) are configured.
- Multiple email domains require support.

There are two quick start mail set up procedures for configuring IBM i mail services described in this chapter. The procedures are:

- Quick start mail set up - Mailhub
- Quick start mail set up - Direct Delivery.

You only perform, at most, one of these. To select the correct procedure consider the following simplified configurations:

Figure: Mail Configurations

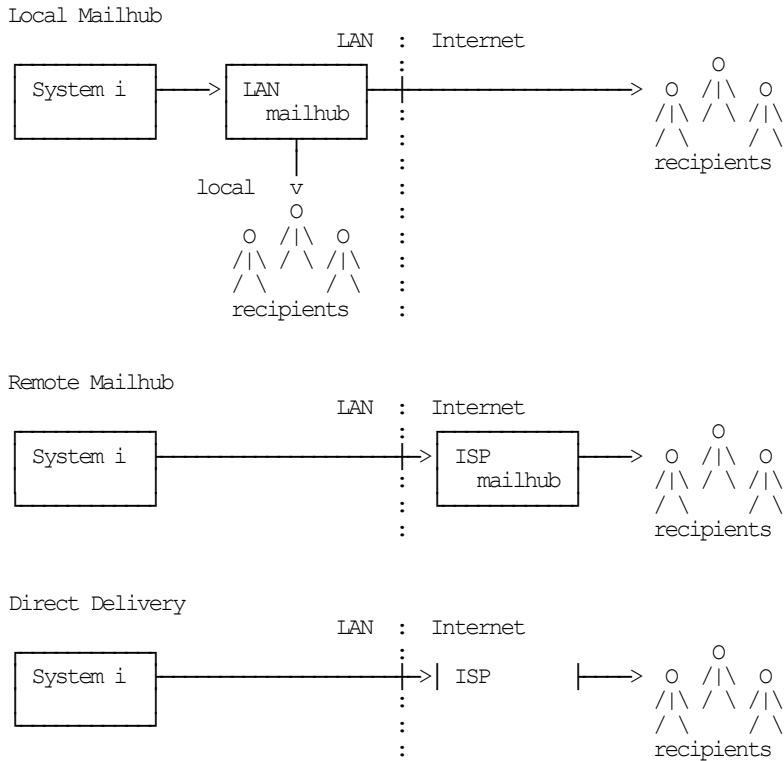

For most customers the System i is attached to a local area network that also has a mail server attached to it. Typically, the mail server runs on a PC with Exchange, Domino, SendMail, or similar mail application installed. Also, typically, this mail server should be responsible for delivering mail, and will server as the forwarding mailhub server for the System i. If this is you situation, proceed to the Quick Start Mail Set Up - Mailhub section.

For some customers, the mail server belonging to their internet service provider (ISP) is used to deliver email. If the ISP's mail server DOES NOT require SMTP authentication, proceed to the Quick Start Mail Set Up - Mailhub section.

If you do not have a mail server capable of serving as a mailhub, or if your ISP's mail server requires SMTP authentication in order to relay email, you must configure your System i to deliver email directly. Proceed to the Quick Start Mail Set Up - Direct Delivery section.

Quick Start Mail Set Up - Mailhub

To configure your System i to use a forwarding mailhub server follow these steps. If any of the steps fail, move on to the detailed sections of this chapter.

1. Install Report Manager on your System i (see the Installation chapter for details).
2. Display the main menu (GO RPTMGR/RPTADM).
3. Run the option to verify that Report Manager is installed correctly.
4. Display the Mail Verification And Set Up menu.
5. Run option 12 to set up the System i.
6. Determine the name and IP address of the mailhub.
7. Run option 14 to set up the mailhub specifying its name and IP.
8. Press F12 to return to the main menu.
9. Send a test to yourself using your "real" email address.
10. Check your email.

If after a reasonable time no email arrives, perform the following additional steps.

1. Add your "real" email address to your directory entry by running (this example uses "real" email address "billg@acme.com" and the directory entry "MYUSER MYSYSTEM"):

```
CHGDIRE USRID (MYUSER MYSYSTEM)
        MSFSRVLVL (*SYSMS)  PREFADR (*SMTP)
        USRDFNFLD ((SMTPAUSRID SMTP 'billg')
                  (SMTPDMN SMTP 'acme.com'))
```

Note: If you are still signed on as QSECOFR, start a second session and sign on with your regular user profile to perform the send.

2. Display the Mail Verification And Set Up menu.
3. Run option 61 to restart/purge local mail on your System i.

Note: If your System i is currently being used to generate email from another application, make sure the Clear SMTP during restart (SMTPPURGE) and Clear MSF during restart (MSFPURGE) parameters specify *NO to prevent email from being deleted.

4. Send a test to yourself taking by taking the default *CURRENT.
5. Check your email.

If after a reasonable time no email arrives, move on to the detailed sections of this chapter. For additional information, see the *Trouble-Shooting* chapter of this manual.

Quick Start Mail Set Up - Direct Delivery

If your installation does not include a mail server or if you cannot use your ISP's mail server because it requires SMTP Authentication which is not support by IBM i, you can configure your System i to directly deliver email to the world at large using the following steps. If any of the steps fail, move on to the detailed sections of this chapter.

1. Install Report Manager on your System i (see the Installation chapter for details).
2. Display the main menu (GO RPTMGR/RPTADM).
3. Run the option to verify that Report Manager is installed correctly.
4. Display the Mail Verification And Set Up menu.
5. Run option 12 to set up the System i.
6. Configure IBM i access to DNS (see Manual Mail Set Up Steps).
7. Remove previously configured mailhub and mail router (see Manual Mail Set Up Steps).
8. Update the public DNS records for your domain (see Manual Mail Set Up Steps).
9. Press F12 to return to the main menu.
10. Send a test to yourself using your "real" email address.
11. Check your email.

If after a reasonable time no email arrives, perform the following additional steps.

1. Add your "real" email address to your directory entry by running (this example uses "real" email address "billg@acme.com" and the directory entry "MYUSER MYSYSTEM"):

```
CHGDIRE USRID (MYUSER MYSYSTEM)
        MSFSRVLVL (*SYSMS)  PREFADR (*SMTP)
        USRDFNFLD ((SMTPAUSRID SMTP 'billg')
                  (SMTPDMN SMTP 'acme.com'))
```

Note: If you are still signed on as QSECOFR, start a second session and sign on with your regular user profile to perform the send.

2. Display the Mail Verification And Set Up menu.
3. Run option 61 to restart/purge local mail on your System i.

Note: If your System i is currently being used to generate email from another application, make sure the Clear SMTP during restart (SMTPPURGE) and Clear MSF during restart (MSFPURGE) parameters specify *NO to prevent email from being deleted.

4. Send a test to yourself taking by taking the default *CURRENT.
5. Check your email.

If after a reasonable time no email arrives, move on to the detailed sections of this chapter. For additional information, see the *Trouble-Shooting* chapter of this manual.

Using The SMTP Set Up Command

The Verify/Set Up Local SMTP (VFYLOCAL) command performs automatic verification and set up of SMTP on your System i. The command accepts a single parameter that determines if changes are made to IBM i. To verify the System i without making any changes select option 11 on the Mail Verification And Set Up menu or run the following command:

```
VFYLOCAL SETUP (*NO)
```

To make changes to your System i select option 12 on the Mail Verification And Set Up menu or run the following command:

```
VFYLOCAL SETUP (*YES)
```

In both cases SMTP verification is performed. Only if SETUP(*YES) is specified does the command try to perform set up functions. You must be authorized to perform all of the verification and set up functions or the command fails. You can insure that you are authorized to perform all functions by signing on as QSECOFR.

Note: If you prefer to manually perform the functions of this program see the Appendix for a detailed description.

A log of activity is created during verification and set up. To view the log run DSPJOB, take option 4 and display the last spooled file.

If errors were encountered, detailed information can be found in your joblog. To view the information generated by VFYLOCAL, run the following command after the command has completed:

```
DSPJOBLOG
```

When the joblog is displayed, press F10 to display detailed messages and F18 to position to the end of the log.

The recommended procedure is to run verification first and review the results before running automatic set up.

Using The Mailhub Set Up Command

The Verify/Set Up Mailhub Server (VFYMAILHUB) command performs automatic verification and set up of a forwarding mailhub server for your System i. The command accepts three parameters that determine if changes are made to IBM i and the identity of the mailhub. To verify the mailhub without making any changes select option 13 on the Mail Verification And Set Up menu or run the following command (substitute the name and IP address of your forwarding mailhub server for "host_name" and "ip"):

```
VFYMAILHUB RMTSYS(host_name) INTNETADR(ip) SETUP(*NO)
```

To make changes to your System i select option 14 on the Mail Verification And Set Up menu or run the following command (substitute the name and IP address of your external mailhub for "host_name" and "ip"):

```
VFYMAILHUB RMTSYS(host_name) INTNETADR(ip) SETUP(*YES)
```

In both cases mailhub verification is performed. Only if SETUP(*YES) is specified does the command try to perform set up functions. You must be authorized to perform all of the verification and set up functions or the command fails. You can insure that you are authorized to perform all functions by signing on as QSECOFR.

Note: If you prefer to manually perform the functions of this program see the Appendix for a detailed description.

A log of activity is created during verification and set up. To view the log run DSPJOB, take option 4 and display the last spooled file.

If errors were encountered, detailed information can be found in your joblog. To view the information generated by VFYMAILHUB, run the following command after the command has completed:

```
DSPJOBLOG
```

When the joblog is displayed, press F10 to display detailed messages and F18 to position to the end of the log.

The recommended procedure is to run verification first and review the results before running automatic set up.

Manual Mail Set Up Steps You May Need To Perform

Depending on your System i, network configuration and your intended usage, there are several manual mail set up steps you may need to perform in order to use SMTP. These are described here.

Installing TCP Connectivity Utilities

In order to send email from your System i, SMTP support must be installed. SMTP functions are delivered free of charge with IBM i as part of a separately installed licensed program product: 57xx-TC1 TCP/IP Connectivity Utilities. Detailed installation information and instructions can be found in *IBM i and related software > PDF file... > Installing, upgrading, or deleting IBM i and related software SC41-5120*.

Changing Local Host and Domain Names

SMTP uses your System i's local host and domain name to identify itself to remote SMTP hosts to which it is sending mail. To configure the names:

- Run the Configure TCP/IP (CFGTCP) command.
- Select option 12 (Change TCP/IP domain information).
- Enter a host and domain name for your System i.

As an example, we use **ofc.gumbo.com** as the domain name and the **mailout** as the host name on our machine. If your domain is widget.com you might use:

```
Change TCP/IP Domain (CHGTCPDMN)

Type choices, press Enter.

Host name . . . . . 'mailout'

Domain name . . . . . 'ofc.widget.com'

Domain search list . . . . . *DFT

Host name search priority . . . *LOCAL *REMOTE, *LOCAL, *SAME
Domain name server:
  Internet address . . . . . '192.0.2.1'
                          '192.0.2.2'

Bottom
F3=Exit   F4=Prompt   F5=Refresh   F10=Additional parameters   F12=Cancel
F13=How to use this display   F24=More keys
```

Creating a TCP Interface

A TCP interface establishes your System i identity (internet address) on a given line description. Typically, the line description for a local area network is used.

In order to add a TCP interface to a line description, you must determine the IP address and subnet mask to use. If you have a network administrator or other person responsible for assigning internet (IP) addresses, contact them. If you will connect your System i directly to the Internet, you must request that your internet service provider assign you an IP address or you must request that the Internet Corporation for Assigned Names and Numbers (ICANN) assign you a network number. If you will not connect your System i directly to the internet, and otherwise do not have an IP address for your system, you can use IP address "192.168.1.1" and Subnet Mask "255.255.255.0". This number is taken from the class B "192.168.0.0" network, which is reserved for internal networks as described in *RFC1597*. To add an interface after you have determined an IP address and subnet mask, run the following command:

```
ADDTCPIFC  INTNETADR(192.168.1.1) +
           LIND(line_description_name) +
           SUBNETMASK(255.255.255.0)
```

Substitute your values for the three parameters.

Adding Host Name To Host Table



In order to deliver email correctly IBM i's SMTP host name must be associated with an IP address of one its TCP interfaces. This can be accomplished through DNS or you can add a local host table entry. To add a host table entry for IP address "192.168.1.1" with host name mailout, run the following command:

```
ADDTCPHTE  INTNETADR('192.168.1.1') +
           HOSTNAME(('mailout'))
```

Substitute your values for the two parameters. If the IP address already exists in the host table, use Change TCP/IP Host Table Entry (CHGTCPHTE) command to add the additional host name to the IP address.

Configuring IBM i Access To DNS

When not using a mailhub, System i must access domain name system (DNS) servers to determine how to deliver email for a recipient. Typically, IP addresses for DNS servers are supplied by your internet service provider (ISP) or network administrator. If neither is available, a reasonable guess as to the IPs to use can be retrieved from a PC attached to the local area network that contains the System i:

-  Choose Start > Programs > Accessories > Command Prompt
-  Run command:

```
ipconfig /all 
```

-  Note the IP addresses given for DNS Servers.

To configure System i to use DNS servers and confirm correct operation:

- From the IBM i command line, type CHGTCPDMN and press F4.
- Enter the DNS IP addresses in the Domain name server: Internet address (INTNETADR) parameter, press enter.

```

Change TCP/IP Domain (CHGTCPDMN)

Type choices, press Enter.

Host name . . . . . 'mailout'

Domain name . . . . . 'ofc.widget.com'

Domain search list . . . . . *DFT

Host name search priority . . . *LOCAL      *REMOTE, *LOCAL, *SAME
Domain name server:
  Internet address . . . . . '192.0.2.1'
                          '192.0.2.2'

Bottom
F3=Exit  F4=Prompt  F5=Refresh  F10=Additional parameters  F12=Cancel
F13=How to use this display  F24=More keys

```

This example uses the fictitious DNS IP addresses 192.0.2.1 and 192.0.2.2

- Run the command:

```
ping ibm.com
```

- If you do not get the message "Unknown host, ibm.com" DNS is working correctly.

Note: You may or may not get ping replies, but that is not important.

Removing Previously Configured Mailhub and Mail Router

IBM i will deliver email directly if a mailhub and mail router are not configured. To check or remove the mailhub and mail router specifications, prompt the Change SMTP Attributes (CHGSMTPA) command, page down once and change the Mail router (MAILROUTER) parameter to *NONE:

```

Change SMTP Attributes (CHGSMTPA)

Type choices, press Enter.

User ID delimiter . . . . . '.'          *SAME, *DFT, 2, =, ., &, $...
Mail router . . . . . *NONE

Coded character set identifier 00819      1-65533, *SAME, *DFT
Outgoing EBCDIC/ASCII table:
  Outgoing EBCDIC/ASCII table . *CCSID   Name, *SAME, *CCSID, *DFT
  Library . . . . .             Name, *LIBL, *CURLIB
Incoming ASCII/EBCDIC table:
  Incoming ASCII/EBCDIC table . *CCSID   Name, *SAME, *CCSID, *DFT
  Library . . . . .             Name, *LIBL, *CURLIB
Firewall . . . . . *YES             *SAME, *YES, *NO
Journal . . . . . *YES             *SAME, *YES, *NO
Process all mail through MSF . *YES             *SAME, *YES, *NO
Percent routing character . . *YES             *SAME, *YES, *NO

More...
F3=Exit  F4=Prompt  F5=Refresh  F12=Cancel  F13=How to use this display
F24=More keys

```

Page down three more times and change the Forwarding mailhub server (FWDHUBSVR) parameter to *NONE:

```

Change SMTP Attributes (CHGSMTPA)

Type choices, press Enter.

Override reject connect list . . . *NO          *SAME, *NO, *YES
Allow bare line feed . . . . . *YES          *SAME, *NO, *YES
Verify identification . . . . . *NO          *SAME, *NO, *YES
Allow authentication . . . . . *NONE        *SAME, *RELAY, *LCLRLY, *NONE
Verify MSF messages . . . . . *NO          *SAME, *YES, *NO
Verify from user . . . . . *ALL          *SAME, *ALL, *LIST, *NONE
Forwarding mailhub server . . . *NONE

Bottom
F3=Exit  F4=Prompt  F5=Refresh  F12=Cancel  F13=How to use this display
F24=More keys

```

Updating Public DNS Records

When directly delivering email to the world at large, System i contacts each recipient's mail server and introduces itself using the fully qualified SMTP host name configured using the Change TCP/IP Domain (CHGTCPDMN) command. In the example below, the machine introduces itself as mailout.ofc.widget.com.

```

Change TCP/IP Domain (CHGTCPDMN)

Type choices, press Enter.

Host name . . . . . 'mailout'
Domain name . . . . . 'ofc.widget.com'

Domain search list . . . . . *DFT

Host name search priority . . . *LOCAL          *REMOTE, *LOCAL, *SAME
Domain name server:
  Internet address . . . . . '192.0.2.1'
                          '192.0.2.2'

Bottom
F3=Exit  F4=Prompt  F5=Refresh  F10=Additional parameters  F12=Cancel
F13=How to use this display  F24=More keys

```

When a recipient's mail server is contacted by IBM i, the mail server sees the traffic as coming from the publicly visible IP address of your connection. For example, the external IP address of your DSL modem. To determine the IP address seen externally, go to <http://network-tools.com>. The IP address shown in the search box is the external public IP address of your connection.

Increasingly, mail servers are confirming the identity of machines sending email by performing a DNS look up on the fully qualified host name sent during the introduction, mailout.ofc.widget.com in this example. If the IP address returned by DNS is not the same as the visible IP address the traffic is coming from, email is rejected or discarded as spam.

To insure that your System i passes this test, you must add, or have your domain registrar add, an address record for your System i's fully qualified SMTP host name to the DNS records for your domain. In this example:

```
mailout.ofc.widget.com. IN A nnn.nnn.nnn.nnn
```

Is added to the DNS records for the domain widget.com where nnn.nnn.nnn.nnn is the publicly visible IP address determined above. This usually requires contacting your domain name registrar or the ISP hosting your domain, and is not an IBM i setting.

Setting Up Local Users

A local user is someone who has a user profile (sign-on) on your System i. You should set up each local user who will be sending email to insure that the apparent "From:" address in the email will be correct and to insure that replies reach the sender. You do not need to set up local users who will not be sending mail. To configure hypothetical user JOE SALES (user profile JOES) as joe@acme.com, perform the following:

- If Joe already has a directory entry run:

```
CHGDIRE USRID(JOE SALES) MSFSRVLVL(*SYSMS)
      PREFADR(*SMTP)
      USRDFNFLD((SMTPAUSRID SMTP 'joe')
                (SMTPDMN SMTP 'acme.com'))
```

- If Joe does not have a directory entry run:

```
ADD DIRE USRID(JOE SALES) USRD('Sample entry')
      USER(JOES) SYSNAME(*LCL)
      MSFSRVLVL(*SYSMS) PREFADR(*SMTP)
      USRDFNFLD((SMTPAUSRID SMTP 'joe')
                (SMTPDMN SMTP 'acme.com'))
```

The user is now ready to send mail from your System i as joe@acme.com. For more details or information on setting up remote users, see the *Email Addresses* section of the *Implementation* chapter of this manual.

Changing The System Start Program

You may wish to check your system's start up program to insure that the required subsystems are started automatically when your System i IPLs. The following steps are recommended:

- Insure that the SMTP server starts automatically when the Start TCP/IP (STRTCP) command is run:

```
CHGSMTPA AUTOSTART(*YES)
```

- Insure that your system start up program starts TCP/IP by including the command:

```
STRTCP
```

- Insure that your system start up program starts the IBM i Mail Server by including the command:

```
STRMSF
```

Changing The Time Zone System Value

The time stamp placed in the email is based on the QTIMZON system value. Since most System i have the correct time, an incorrect time stamp usually indicates an incorrect time zone setting. For information on correctly setting the QTIMZON system value see the *System management > Time management* topic in the IBM i Information Center at <http://publib.boulder.ibm.com/series/>.

Note: QTIMZON also affects the timestamp applied to files in the Integrated File System (IFS).

Changing The SMTP Port Number

Some installations use an SMTP port number other than the well-known port 25. You can control the port number used by IBM i's SMTP stack by running the Configure TCP/IP (CFGTCP) command, selecting option 21. Configure related tables, then selecting option 1. Work with service table entries.

Additional Mail Set Up Resources

The information in this chapter was drawn and condensed from the IBM i Information Center. You can find additional detail and more comprehensive coverage of IBM i configuration by going to the *Networking > TCP/IP applications, protocols, and services > E-mail* topic in the IBM i Information Center at <http://publib.boulder.ibm.com/series/>.

For Domino on System i users, our software uses IBM i's SMTP services to deliver mail. Valuable information on setting up Domino's and IBM i's SMTP stack to coexist on the same System i can be found in the IBM Redbook *V5 TCP/IP Applications on the IBM eServer iSeries Server SG24-6321* available at <http://publib.boulder.ibm.com/series/>.

Appendix A Record Descriptions

What's In This Appendix

This appendix provides information on Report Manager files and structures. The appendix:

- Describes report distribution log contents.
- Describes the report log event record.
- Describes the report log distribution record.
- Describes the report log message record.
- Describes the report filter record.
- Describes the report subscription *BASIC record.
- Describes the report subscription *FULL record.
- Describes the report writer control record.
- Describes the display page data record.

Report Distribution Log Contents

The report distribution log contains information about the work performed by report writers. The log contains entries for each spooled file processed, each delivery made, and any errors or warnings encountered.

The log data is made up of three record formats:

Record	Description
RMEVTR	An event (report) record is written to physical file RMEVT for each spooled file processed or created by a report writer. The record contains information about the overall status of the spooled file and has the spooled file's identity as its primary key.
RMDSTR	A distribution (subscription) record is written to physical file RMDST for each subscription processed as a result of processing an event. The record contains information about the status of the distribution and uses the spooled file's identity combined with the subscription's identity as its primary key.
RMMSGR	A message (error) record is written to physical file RMMSG for each error encountered while processing events and distributions. The record contains information about the error and is keyed to the event or distribution that caused the problem.

Report Log Event Record

The report log event record is in file RMEVT which is maintained by Report Manager.

The event record RMEVTR is made up of several groups of fields that describe the response to a spooled file:

- Record stamp. These fields provide information about the record itself.

LEID	Record ID, always "E".
LERDAT	Date of last activity for this record in CYY/MM/DD format.
LERTIM	Time of last activity for this record in HH:MM:SS format.
LESYS	System on which the record was generated.

- Spooled file identification. These fields uniquely identify the spooled file.

LEJOB	Job name that created the spooled file.
LEUSR	User name that created the spooled file.
LENBR	Job number that created the spooled file.
LESPF	The spooled file's name.
LESPF#	The spooled file's number within the job.

- Report. These fields identify the report used to determine distribution information.

LERPT Name of the report.
LERPTL Library in which the report was found.

- Processing information.

LERSTS The current status of the event.

- *NEW** The staging process is in progress for the spooled file. A report writer creates a report distribution log entry with a status of ***NEW** as it starts processing a spooled file, and before the staging of subscriptions.
- *STAGED** The processing preliminary to delivery of report subscriptions has been completed for this entry.
- *DELIVERED** The spooled file has been delivered to all destinations specified by the report. While the spooled file is on all required output queues, printing may not be complete.
- *PRINTED** The entry was forwarded by a report writer to a printer writer for printing. The printer writer may still be processing the spooled file.
- *CREATED** The spooled file has been converted and an object (PC file) has been created with the name specified in the TOOBJ() parameter.
- *HELD** A report writer processed the spooled file for a report that has been held. A held report is ineligible for processing. The spooled file was held and none of the actions specified by the report were taken. The report remains held until a Release Report (RLSRPT) command is issued. After the report has been released, distribution processing can be initiated by releasing the spooled file.
- *ERROR** An error was encountered during processing of this entry.
- *VOIDED** The entry was forwarded by a report writer to an output queue processed by a second report writer. The second report writer selected a different report name for the spooled file and voided the entry created by the first report writer.

LECOQN The name of the output queue on which the spooled file was last located. If the spooled file is still on the system, this is the output queue on which the spooled file is currently located.

LECOQL The name of the output queue's library.

- Logical spooled file identification. During processing a report writer may produce a duplicate of a spooled file in order to deliver it to multiple destinations. These fields uniquely identify the original spooled file from which the spooled file identified above was duplicated. If the spooled file is not a duplicate these fields match the spooled file identification.

LEJOB Job name that created the original spooled file.
LEUSR User name that created the original spooled file.
LENBR Job number that created the original spooled file.
LESPF The original spooled file's name.
LESPF# The original spooled file's number within the job.

- Original spooled file values. During processing a report writer may change a spooled file's attributes. These fields contain data as it was first found on the spooled file, before any changes by a report writer.

LE1OQN The name of the output queue on which the spooled file was first located.
LE1OQL The name of the output queue's library.
LE1FRM The spooled file's first form type.
LE1CPY The spooled file's first copies value.

- Statics. These fields contain processing counts.

LES#SB The number of staged subscriptions.

LES#CP	The number of staged copies.
LED#ER	The number of delivery errors.
LED#QS	The number of subscriptions queued for delivery.
LED#PG	The number of pages queued for delivery.

- Filter, archive and last writer information.

LEFTRN	Name of the report filter used to select pages for distribution.
LEARCN	Name of the user space containing the spooled file in archived form.
LEARCL	Library in which the archive was placed.
LEWTRN	Name of the last report writer to process the spooled file.
LEBITS	User data for the record. The value of this field is inherited by the event records of all new copies of this spooled file.
LEBITI	Internal data for the record.

Report Log Distribution Record

The report log distribution record is in file RMDST which is maintained by Report Manager.

The distribution record RMDSTR is made up of several groups of fields that describe the distribution of a subscription in response to an event (spooled file):

- Record stamp. These fields provide information about the record itself.

LDID	Record ID, always "D".
LDRDAT	Date of last activity for this record in CYY/MM/DD format.
LDRTIM	Time of last activity for this record in HH:MM:SS format.
LDSYS	System on which the record was generated.

- Spooled file identification. These fields uniquely identify the spooled file.

LDJOB	Job name that created the spooled file.
LDUSR	User name that created the spooled file.
LDNBR	Job number that created the spooled file.
LDSPF	The spooled file's name.
LDSPF#	The spooled file's number within the job.

- Report. These fields identify the report that contained the subscription.

LDRPT	Name of the report.
LDRPTL	Library in which the report was found.

- Subscription. These fields uniquely identify the subscription.

LDSUBT	Subscriber type. U = User profile The subscription is on behalf of a user profile. N = Network ID The subscription is on behalf of a network user.
LDSUBN	Subscriber name data. When the type is "U" this field contains the user profile name in the first 10 positions padded with blanks in the last 6 positions. When the type is "N" this field contains the network ID with the User ID portion in the first 8 positions and the Address portion in the second 8 positions.
LDSUB#	Subscription number. This field uniquely identifies multiple subscriptions to a single report for the same subscriber.

- Processing information.

LDSSTS	The current status of the distribution.
*STAGED	The processing preliminary to delivery of report subscriptions has been completed for this entry.
*QUEUED	The entry was forwarded by a report writer to an output queue.
*READY	The entry was delivered by a report writer and is ready to be printed.
*PRINTED	The entry was forwarded by a report writer to a printer writer for printing. The printer writer may still be processing the spooled file.
*SENT	The spooled file was sent to the network user specified on the subscription.
*CALLED	The program specified as the destination of the report subscription was called.
*CREATED	The object (PC file) specified as the destination of the report subscription was created.
*HELD	The spooled file was held by an operator.
*OMITTED	Delivery was omitted for the subscription because the filter selected zero pages and omit zero page delivery was specified.
*ERROR	An error was encountered during processing of this entry.
*VOIDED	The entry was forwarded by a report writer to an output queue processed by a second report writer. The second report writer selected a different report name for the spooled file and voided the entry created by the first report writer.
LDCOQN	The name of the output queue on which the spooled file was last located. If the spooled file is still on the system, this is the output queue on which the spooled file is currently located.
LDCOQL	The name of the output queue's library.

- Destination. These fields describe the destination of the distribution.

LDDSTT	Destination type.
1 = *PROGRAM	The subscription calls a user process program.
2 = *USRID	The subscription is delivered to a network user using the Send Network Spooled File command or as email.
3 = *PRINTER	The subscription is delivered to a printer device.
4 = *OUTQ	The subscription is delivered to an output queue.
5 = *OBJECT	The subscription creates an object (PC file).
LDDSTN	Name of the destination. This is either the object's name, the user ID portion of a network ID, or blank in the case of a PC file.
LDDSTL	Destination qualifier. This is either a library that qualifies the object name, blank in the case of a printer device, the address portion of a network ID, or blank in the case of a PC file.

- Delivery information. These fields contain additional delivery information for the distribution.

LDGRP	The name of the report group.
LDBIN	The name of the delivery point.
LDFRM	The form type.
LDCPYS	The number of copies.
LDFTRN	The name of the report filter used to select pages from the spooled file.
LDBITS	User data for the record.
LDWTRN	Name of the last report writer to process the record.
LDZPOM	Omit zero page delivery
LDDLVS	Deliver status
LDSNDF	Send format
LDFTRS	The report filter internal processing sequence.
LDSUBJ	Subject
LDTRNF	Transform to perform
LDTOBJ	Object (PC file)

Note: The *PACKSLIP separator program uses bit number 7 (right most or least significant) of the **LDBITS** user data field to flag records that have been printed. If you use the *PACKSLIP separator program, avoid use of this bit for other purposes.

Report Log Message Record

The report log message record is in file RMMSG which is maintained by Report Manager.

The message record RMMSGR is made up of several groups of fields that describe an error and the event or distribution to which it applies. All fields will not necessarily contain data. This occurs when the fields don't apply or are unknown. For example an error against an event will not contain information on subscription destination:

- Record stamp. These fields provide information about the record itself.

LMID Record ID, always "M".
LMRDAT Date of last activity for this record in CYY/MM/DD format.
LMRTIM Time of last activity for this record in HH:MM:SS format.
LMSYS System on which the record was generated.

- Spooled file identification. These fields uniquely identify the spooled file to which the error pertains.

LMJOB Job name that created the spooled file.
LMUSR User name that created the spooled file.
LMNBR Job number that created the spooled file.
LMSPF The spooled file's name.
LMSPF# The spooled file's number within the job.

- Report. These fields identify the report used to determine processing.

LMRPT Name of the report.
LMRPTL Library in which the report was found.

- Subscription. These fields uniquely identify the subscription.

LMSUBT Subscriber type.
U = User profile The subscription is on behalf of a user profile.
N = Network ID The subscription is on behalf of a network user.
LMSUBN Subscriber name data. When the type is "U" this field contains the user profile name in the first 10 positions padded with blanks in the last 6 positions. When the type is "N" this field contains the network ID with the User ID portion in the first 8 positions and the Address portion in the second 8 positions.
LMSUB# Subscription number. This field uniquely identifies multiple subscriptions to a single report for the same subscriber.

- Error Data. These fields contain an API error code parameter. For a complete description see the *Programming > Application programming interfaces > API concepts > API parameters > Error code parameter* topic in the IBM i Information Center at <http://publib.boulder.ibm.com/iseres/>.

LMABPR Bytes provided.
LMABAV Bytes available.
LMAMID The message identifier under which the message is stored in a message file. The identifier is 7 characters in length and has the format pppnnnn. The name of the message file containing the message can usually be determined from the first 3 characters. Some common combinations and their associated message files are:

	○ CPFnnnn - QCPFMSG
	○ MCHnnnn - QCPFMSG
	○ RDMnnnn - RMMSGF
LMARSV	Reserved.
LMADTA	Message substitution data.

- Additional information.

LEWTRN Name of the report writer that generated the message.

Report Filter Record

The report filter record is in model file RMFTR which is used by the Work with Report Filters (WRKRPTFTR) command to generate output files.

The filter record RMFTRR is made up of several groups of fields that describe a report filter:

- Record stamp. These fields provide information about the record itself.

RFRDAT Date the record was created in CYY/MM/DD format.
RFRTIM Time the record was created in HH:MM:SS format.
RFSYS System on which the record was generated.

- Filter identification. These fields uniquely identify the filter.

RFRPT Name of the report.
RFRPTL Library in which the report was found.
RFFTRN Name of the filter.

- Page compare data. The fields describe the test that the filter applies to determine if a page is selected for distribution.

RFFLIN Line number on the page where the comparison occurs. The possible values for this field range from 1 through 255. The special value *ALL is represented by -1.
RFFPOS Position number in the line where the comparison occurs. The possible values for this field range from 1 through 378 minus the length of the compare data. The special value *ALL is represented by -1.
RFFLEN Length of the compare data to match. The possible values for this field range from 1 through 16.
RFFDTA Data to compare to the page to determine if the page is selected for distribution.
RFFOPR Test to perform between page and compare data to determine if the page is selected for distribution.
x'00' = *EQ Equal test is performed.
N = *NE Not equal test is performed.

- Count of additional page compare data sets

RFFCNT Number of additional comparison specified and hence the number of the following group that are meaningful.

- Additional page compare data. The fields describe the additional tests that the filter applies to a page, and the relationship between them. The fields are repeated 15 times with **xx** replace with 01 through 15, in sequence.

RFFCNJxx Conjunction between this comparison and the preceding, (or first) comparison.
x'00' = *NONE No test specified or performed.

	A = *AND	And conjunction used.
	O = *AND	Or conjunction used.
RFFLINxx	Line number on the page where the comparison occurs. The possible values for this field range from 1 through 255. The special value *ALL is represented by -1.	
RFFPOSxx	Position number in the line where the comparison occurs. The possible values for this field range from 1 through 378 minus the length of the compare data. The special value *ALL is represented by -1.	
RFFLENxx	Length of the compare data to match. The possible values for this field range from 1 through 16.	
RFFDTAxx	Data to compare to the page to determine if the page is selected for distribution.	
RFFOPRxx	Test to perform between page and compare data to determine if the page is selected for distribution.	
	x'00' = *EQ	Equal test is performed.
	N = *NE	Not equal test is performed.

Report Subscription *BASIC Record

The report subscription *BASIC record is in model file RMSUBB which is used by the Work with Report Subscriptions (WRKRPTSUB) command to generate output files when DETAIL(*BASIC) is specified.

The *BASIC subscription record RMSUBBR is made up of several groups of fields that describe a subscription:

- Record stamp. These fields provide information about the record itself.

SBRDAT	Date the record was created in CYY/MM/DD format.
SBRTIM	Time the record was created in HH:MM:SS format.
SBSYS	System on which the record was generated.

- Report. These fields identify the report that contained the subscription.

SBRPT	Name of the report.
SBRPTL	Library in which the report was found.

- Subscription. These fields uniquely identify the subscription.

SBSUBT	Subscriber type.
	U = User profile The subscription is on behalf of a user profile.
	N = Network ID The subscription is on behalf of a network user.
SBSUBN	Subscriber name data. When the type is "U" this field contains the user profile name in the first 10 positions padded with blanks in the last 6 positions. When the type is "N" this field contains the network ID with the User ID portion in the first 8 positions and the Address portion in the second 8 positions.
SBSUB#	Subscription number. This field uniquely identifies multiple subscriptions to a single report for the same subscriber.

- Destination. These fields describe the destination of the subscription.

SBDSTT	Destination type.
	1 = *PROGRAM The subscription calls a user process program.
	2 = *USRID The subscription is delivered to a network user using the Send Network Spooled File command or as email.
	3 = *PRINTER The subscription is delivered to a printer device.
	4 = *OUTQ The subscription is delivered to an output queue.
	5 = *OBJECT The subscription creates an object (PC file).
SBDSTN	Name of the destination. This is either the object's name or the user ID portion of a network ID.
SBDSTL	Destination qualifier. This is either a library that qualifies the object name, blank in the case of a printer device, or the address portion of a network ID.

- Effectivity information. These fields describe when the subscription is in effect.

SBSTRD	Date the subscription takes effect in CYY/MM/DD format. The special value *IMMED is represented by the value 13/13/13.
SBENDD	Last date the subscription is in effect in CYY/MM/DD format. The special value *PERM is represented by the value 14/14/14.
SBSHLD	Whether the subscription is held.

- Delivery information. These fields contain additional delivery information for the subscription.

SBBIN	The name of the delivery point.
SBFRM	The form type.
SBCPYS	The number of copies.
SBFTRN	The name of the report filter used to select pages from the spooled file.

- Additional fields

SBSZPO	Subscription's omit zero page delivery parameter. Y = *YES Omit delivery of the subscription when the filter selects zero pages. N = *NO Deliver zero pages. R = *RPT Use the report's setting.
SBSDLV	Subscription's deliver status parameter. G = *READY Spooled files are delivered in a ready status and may begin printing at once. H = *HELD Spooled files are delivered held. R = *RPT Use the report's setting.
SBSSEND	Subscription's send format parameter. A = *ALLDATA Spooled files are delivered using the Send Net Spooled File (SNDNETSPLF) command with DTAFMT(*ALLDATA). E = *EMAIL Spooled files are delivered as email. R = *RCDDATA Spooled files are delivered using the Send Net Spooled File (SNDNETSPLF) command with DTAFMT(*RCDDATA). T = *RPT Use the report's setting.
SBSTRN	Subscription's transform parameter.
SBSOBJ	Subscription's to object parameter.

Report Subscription *FULL Record

The report subscription *FULL record is in model file RMSUBF which is used by the Work with Report Subscriptions (WRKRPTSUB) command to generate output files when DETAIL(*FULL) is specified.

The *FULL subscription record RMSUBFR is made up of several groups of fields that describe a subscription and its report.

- Record stamp. These fields provide information about the record itself.

SBRDAT	Date the record was created in CYY/MM/DD format.
SBRTIM	Time the record was created in HH:MM:SS format.
SBSYS	System on which the record was generated.

- Report. These fields identify the report that contained the subscription.

SBRPT	Name of the report.
SBRPTL	Library in which the report was found.

- Subscription. These fields uniquely identify the subscription.

SBSUBT	Subscriber type. U = User profile The subscription is on behalf of a user profile. N = Network ID The subscription is on behalf of a network user.
SBSUBN	Subscriber name data. When the type is "U" this field contains the user profile name in the first 10 positions padded with blanks in the last 6 positions. When the type is "N" this field contains the network ID with the User ID portion in the first 8 positions and the Address portion in the second 8 positions.
SBSUB#	Subscription number. This field uniquely identifies multiple subscriptions to a single report for the same subscriber.

- Destination. These fields describe the destination of the subscription.

SBDSTT	Destination type. 1 = *PROGRAM The subscription calls a user process program. 2 = *USRID The subscription is delivered to a network user using the Send Network Spooled File command or as email. 3 = *PRINTER The subscription is delivered to a printer device. 4 = *OUTQ The subscription is delivered to an output queue. 5 = *OBJECT The subscription creates an object (PC file).
SBDSTN	Name of the destination. This is either the object's name or the user ID portion of a network ID.
SBDSTL	Destination qualifier. This is either a library that qualifies the object name, blank in the case of a printer device, or the address portion of a network ID.

- Effectivity information. These fields describe when the subscription is in effect.

SBSTRD	Date the subscription takes effect in CYY/MM/DD format. The special value *IMMED is represented by the value 13/13/13.
SBENDD	Last date the subscription is in effect in CYY/MM/DD format. The special value *PERM is represented by the value 14/14/14.
SBSHLD	Whether the subscription is held.

- Delivery information. These fields contain additional delivery information for the subscription.

SBBIN	The name of the delivery point.
SBFRM	The form type.
SBCPYS	The number of copies.
SBFTRN	The name of the report filter used to select pages from the spooled file.

- Report information. These fields contain details from the report containing the subscription.

SBOQNM	The name of the destination output queue.
SBOQLB	Library in which the output queue is located.
SBPDEV	Printer device parameter.
SBFRMR	The form type specified by the report.
SBCPYR	The number of copies specified by the report.
SBRHLD	Whether the report is held.
SBUPPN	The name of the user process program specified by the report.
SBUPPL	Library in which the user process program is located.
SBALWS	Whether the report allows subscriptions to be added.
SBGRP	The name of the report group
SBBINR	The name of the delivery point specified by the report.
SBDSCH	Reserved.
SBABST	Abstract describing the report.

SBTEXT Text from the report's *USRIDX.
SBARCL The library that receives the archives created by report writers for each spooled file processed.

- Additional fields

SBRZPO Report's omit zero page delivery parameter.
Y = *YES Omit delivery of subscriptions when the filter selects zero pages.
N = *NO Deliver zero pages.

SBRDLV Report's deliver status parameter.
G = *READY Deliver spooled file in ready status.
H = *HELD Deliver spooled file in held status.

SBRSEND Report's send format parameter.
A = *ALLDATA Spooled files are delivered using the Send Net Spooled File (SNDNETSPLF) command with DTAFMT(*ALLDATA).
E = *EMAIL Spooled files are delivered as email.
R = *RCDDATA Spooled files are delivered using the Send Net Spooled File (SNDNETSPLF) command with DTAFMT(*RCDDATA).

SBSZPO Subscription's omit zero page delivery parameter.
Y = *YES Omit delivery of the subscription when the filter selects zero pages.
N = *NO Deliver zero pages.
R = *RPT Use the report's setting.

SBSDLV Subscription's deliver status parameter.
G = *READY Spooled files are delivered in a ready status and may begin printing at once.
H = *HELD Spooled files are delivered held.
R = *RPT Use the report's setting.

SBSSEND Subscription's send format parameter.
A = *ALLDATA Spooled files are delivered using the Send Net Spooled File (SNDNETSPLF) command with DTAFMT(*ALLDATA).
E = *EMAIL Spooled files are delivered as email.
R = *RCDDATA Spooled files are delivered using the Send Net Spooled File (SNDNETSPLF) command with DTAFMT(*RCDDATA).
T = *RPT Use the report's setting.

SBSTRN Subscription's transform parameter.
SBSOBJ Subscription's to object parameter.

Report Writer Control Record

The writer control record is in model file RMWTR. The record is used by report writers as one of the three parameters passed to separator programs and contains information from the Start Report Writer (STRRPTWTR) command that started the report writer.

The record RMWTRR is made up of several groups of fields that correspond to command parameters:

- Printer (DEV)

RWPDEV The device name or *NONE.

- Output queue (OUTQ)

RWOQNM Name of the output queue.

RWOQLB Library in which the output queue was found.

- Queue for writer messages (MSGQ)

RWMQNM Name of the message queue.
RWMLB Library in which the message queue was found.

- Default destination queue (DFTOUTQ)

RWOQDN Name of the default output queue.
RWOQDL Library in which the default output queue was found.

- Report library list (RPTLIBL)

RW#RLB System supplied number of libraries entered.
RWRLB1 First library name.
RWRLB2 Second library name.
RWRLB3 Third library name.
RWRLB4 Fourth library name.
RWRLB5 Fifth library name.

- Print options (PRTOPT)

RWOFRM Form type.
RWOGRP Report group.
RWOBIN Delivery point.
RWOUSR User.
RWOMSG Message option.

- Separator print program (SEPPGM)

RWSEPN Name of the separator program.
RWSEPL Library in which the separator program was found.

- Reserved

RWFSTN Reserved.
RWFSTL Reserved.

- File separators (FILESEP)

RWFILS Number of separators.

- Drawer for separators (SEPDRAWER)

RWSDRW Separator drawer.

- Writer (WTR)

RWWTRN Report writer name.

- Align page (ALIGN)

RWALGN Align: *WTR *FILE.

- Library to receive archive (ARCLIB)

RWARCL Archive library.

- Auto-end options (AUTOEND)

RWAEND Automatically end writer.

RWAEWH If yes, when to end.

- Optimize (OPTIMIZE)

RWOPTM Optimize

Display Page Data Record

The display page data record PDPAGDRF is in model file RMPAGDD which is used by the Display Page Data (DSPPAGDTA) command to generate output files.

PDPAGDRF is made up of several groups of fields that describe an element of the page.

- Spooled file. These fields provide information about the spooled file from which the data was taken.

PDJSYS Name of the system where the job that created the spooled file ran.

PDJJOB Name of the job that created the spooled file.

PDJUSR Name of the user who produced the spooled file.

PDJNBR Number of the job in the system.

PDJSPF Name of the spooled file.

PDJSP# Spooled file number within the job.

- Location. These fields describe the location of the data in the spooled file.

PDPAGE Page number.

PDLINE Line number the data appears on.

-53 = *DOCIDXTAG The data was added to the spooled file using the DDS DOCIDXTAG() keyword at either the page level or group level.

-54 = *DOCIDXPAG The data was added to the spooled file using the DDS DOCIDXTAG() keyword at the page level.

-55 = *DOCIDXGRP The data was added to the spooled file using the DDS DOCIDXTAG() keyword at the group level.

-56 = *STRPAGGRP The data was added to the spooled file using the DDS STRPAGGRP() keyword.

-57 = *DOCIDXTAGP The data was added to the spooled file using the DDS DOCIDXTAG() keyword at the page level, group level or was propagated from the group level to all pages in the group.

-58 = *DOCIDXGRPP The data was added to the spooled file using the DDS DOCIDXTAG() keyword at the group level or was propagated from the group level to all pages in the group.

-59 = *STRPAGGRPP The data was added to the spooled file using the DDS STRPAGGRP() keyword or was propagated from the keyword to all pages in the page group.

PDPOS Position on the line the data starts. When PDLINE contains one of the special values, PDPOS is zero.

- Data. These fields contain the data.

PDVLEN	Length of data contained in the following field.
PDVDTA	Data retrieved from the page. When PDLINE is one of the special values related to the DDS STRPAGGRP() keyword, PDVDTA contains the "group-name" specified. When PDLINE is one of the special values related to the DDS DOCIDXTAG() keyword, PDVDTA contains the "attribute-value" specified.
PDNLEN	Length of data contained in the following field.
PDNDTA	Name data. When PDLINE is one of the special values related to the DDS DOCIDXTAG() keyword, PDNDTA contains the "attribute-name" specified otherwise it is blank.

Appendix B Process Descriptions

What's In This Appendix

This appendix provides detailed descriptions of the processing performed by Report Manager's mail set up and verification programs. In highly secure environments, it may be against policy to allow third party software to change your system. If this is your situation, you can perform these steps manually. The appendix details:

- Processing Performed During SMTP Verification
- Processing Performed During SMTP Set Up
- Processing Performed During Mailhub Verification
- Processing Performed During Mailhub Set Up

SMTP Verification Process

The following verification steps are performed by the Verify/Set Up Local SMTP (VFYLOCAL) command when SETUP(*NO) is specified.

Note: No changes are made to your system during verification.

- Verify that TCP Utilities have been installed on the system.

The system is checked to insure that library QTCP exists. If the library is found then the TCP Connectivity Utilities have been installed on the system.

- Verify that the SMTP distribution queues are present.

The system is checked for the existence of QSMTPQ distribution queue.

- Verify that a host and domain name have been configured for the system.
 - If the host name is blank, verification fails.
 - If the domain name is blank, verification fails.
- Verify that the system distribution directory is searchable.

A search is attempted on the system distribution directory.

- Verify that the IBM i Mail Server is active.

The system is checked for an active job with the job name QMSF. If one or more QMSF jobs are active then the Mail Server is active.

- Verify that TCP is active.

The system is checked for an active job with the job name QTCPWRK (before V6 JOB QTCP/IP). If job is active then TCP is active.

- Verify that TCP loopback is operating correctly.

The TCP interfaces are searched to locate the *LOOPBACK IP address. The *LOOPBACK interface is started if it is not active and its IP address is PINGed to verify that TCP is operating correctly.

- If the *LOOPBACK interface is not found, verification fails.
- If the *LOOPBACK interface is not active and can not be started, verification fails.
- If the *LOOPBACK interface can not be PINGed, verification fails.
- Verify that a TCP interface is defined.

The TCP interfaces are searched to locate one or more IP addresses (excluding *LOOPBACK).

- If no interfaces are found, verification fails.
- Verify that active TCP interfaces are reachable.

The TCP interfaces are searched to locate one or more IP addresses (excluding *LOOPBACK). Each interface is contacted (PINGed) to verify the connection.

- If an interface is not active, verification fails.
- If an interface can not be contacted, verification fails.
- Verify that the SMTP server is active.

The system is checked for an active job with the job name QTSMTPSRVR or QTSMTPSRVD. If either job is active then the SMTP server is active.

- Verify that this host's IP address can be reached by SMTP.
 - Retrieve the host and domain names for this system.

If the host name is blank, verification fails.

- Verify TCP/IP connection to the host name.

If the host is contacted, verification is complete and no further processing is performed.

- Verify TCP/IP connection to the host.domain name.

If the host.domain name can not be contacted, verification fails.

- Verify that message splitting has been turned off.

The current setting can not be retrieved so no test is performed and it is assumed that splitting has not been turned off yet.

After all tests are completed, a message summarizing the results is issued.

SMTP Set Up Process

The following set up work is performed by the Verify/Set Up Local SMTP (VFYLOCAL) command when SETUP(*YES) is specified.

- If the TCP utilities have not been installed on the system.
 - Manual intervention is required to install the utilities. Automatic set up can not perform the installation.
- If QSMTPQ distribution queue is not found.
 - Create the distribution queue using the Add Distribution Queue command:

```
ADDSTQ      DSTQ(QSMTPQ) RMTLOCNAME(TCPIPLOC)
            DSTQTYPE(*RPDS)
```

- If a host or domain name have not been configured.
 - Manual intervention is required to configure a host and domain name. Use option 12 (Change local domain and host names) of the Configure TCP/IP (CFGTCP) command. Automatic set up can not perform the change.
- If the system distribution directory entry can not be searched.
 - The directory is changed to allow searches using the Change System Directory Attributes command:

```
CHGSYSDIRA  ALWSCH(*YES)
```

- If the IBM i Mail Server is not active.
 - Start the Mail Server using the STRMSF command:

```
STRMSF
```

- If TCP is not active.
 - Start TCP using the STRTCP command:

```
STRTCP
```

- If TCP loopback is not operating correctly.
 - If missing, *LOOPBACK interface is added using command:

```
ADDTCPIFC  INTNETADR('127.0.0.1') LIND(*LOOPBACK) +
            SUBNETMASK('255.0.0.0') MTU(576)
```

- If loopback PING fails:

Manual intervention is required to correct the problem, which is beyond the scope of set up.

- If no TCP interfaces are found.

Manual operation is required to add an interface using the ADDTCPIFC command.

- If a TCP interface can not be contacted.

Manual operation is required to correct the problem. If the interface can not be contacted because it is not active, start the interface using the STRTCPIFC command.

- If the SMTP server is not active.
 - Start the SMTP server using the STRTCPSVR command:

```
STRTCPSVR  SERVER(*SMTP)
```

- If the host's IP address can not be reached by SMTP.
 - If system is using a remote name server, set up fails.

Manual operation required. Contact the remote name server's administrator to add this system's host name.

- If multiple TCP interfaces are found, set up fails.

Manual operation required. Add this system's name to IBM i's host table using the ADDTCPHTE command.

- If no TCP interfaces are found, set up fails.

Manual operation required. Add a TCP interface using the ADDTCPIFC command.

- An entry is added for this host using the Add TCP Host Table Entry command:

```
ADDTCPHTE  INTNETADR (&INTERNET)  HOSTNAME (( &HOST))  +  
           TEXT('Entry Added By Gumbo Auto TCP/IP +  
           Config')
```

- If message splitting has not been turned off.
 - Message splitting is turned off

The POP attributes are changed:

```
CHGPOPA    MSGSPLIT (*NOMAX)
```

After all steps are completed, a message summarizing the results is issued.

Mailhub Verification Process

The following verification steps are performed by the Verify/Set Up Mail Router (VFYMAILHUB) command when SETUP(*NO) is specified.

Note: No changes are made to your system during verification.

- Verify that TCP is active.

The system is checked for an active job with the job name QTCPWRK (before V6 JOB QTCPPIP). If job is active then TCP is active.

- Resolve system names and internet addresses for command parameters and current mailhub.
 - Verify domain name server.

If a domain name server is configured, it is tested to insure that it is responding. If it does not respond, verification fails.

- Retrieve currently configured mailhub name and IP
- Resolve internet address parameter.

If a special value was specified, it is resolved. If it can not be resolved, verification fails.

- Resolve remote system parameter.

If a special value was specified, it is resolved. If it can not be resolved, verification fails.

- Edit the resulting names and IPs for conflicts.
 - Edit remote system and internet address IP.

If the IP of the remote system is different than the internet address, verification fails.

- Edit remote system and internet address names.

If the name of the internet address is different than the remote system name, verification fails.

- Edit current mailhub and internet address IP.

If the IP of the current mailhub is different than the internet address, verification fails.

- Verify that the internet address is responding.

The internet address is PINGed to insure that it is reachable and responding. If it is not, verification fails.

- Verify that the internet address is accepting SMTP mail.

The internet address is tested to insure that it is accepting SMTP mail from this System i. If it is not, verification fails.

- Verify that remote system's IP can be resolved.

If an IP can not be resolved, verification fails.

- Verify that the mailhub is configured.

If the remote system is not configured as the mailhub, verification fails.

After all tests are completed, a message summarizing the results is issued.

Mailhub Set Up Process

The following set up work is performed by the Verify/Set Up Mail Router (VFYMAILHUB) command when SETUP(*YES) is specified.

- If TCP is not active.
 - Start TCP using the STRTCP command:

```
STRTCP
```

- If system name and internet address resolution fails.
 - If a domain name server is configured but not responding.

Manual intervention required. Either insure that the configured domain name server is available or remove the domain name server from IBM i's configuration using option 13 of the CFGTCP menu.

- If the internet address parameter can not be resolved.

Manual intervention required to correct the internet address parameter.

- If the remote system parameter can not be resolved.

Manual intervention required to correct the remote system parameter.

- Edit the resolved names and IPs for conflicts.
 - If the remote system and internet address IPs are different.

Manual intervention required to correct the parameters.

- If the remote system and internet address names are different.

Manual intervention required to correct the parameters.

- If the current mailhub and internet address IPs are different.

Manual intervention required. Either correct the parameters or remove the currently configured mailhub by running the following command:

```
CHGSMTPA FWDHUBSVR (*NONE)
```

- If the internet address is not responding.

Manual intervention required. Either correct the internet address or make the system at that address ready.

- If the internet address is not accepting SMTP mail.

Manual intervention required. Either correct the internet address, or contact the system's administrator and request that the system accept SMTP from IBM i. The words you use to request this differ depending on the software running on the remote system:

- For Microsoft's Exchange Server request that the "Internet Mail Connector" be configured and started. Then request that "SMTP forwarding" be enabled for your system's IP.
- For Lotus' cc:Mail request that the "Link to SMTP" be configured and started.
- For all others request that the "SMTP gateway" be configured and started.

- If the remote system's IP can not be resolved.

Add an entry using the Add TCP/IP Host Table Entry (ADDTCPHTE) command:

```
ADDTCPHTE INTNETADR (&INTNETADR) HOSTNAME ((&RMTSYS)) +  
          TEXT('Mailhub added by Gumbo +  
              VFYMAILHUB command')
```

- If the mailhub is not configured.

Configure the mailhub using the Change SMTP Attributes (CHGSMTPA) command:

```
CHGSMTPA FWDHUBSVR (&RMTSYS)
```

After all steps are completed, a message summarizing the results is issued.

Appendix C Notices

© Copyright Gumbo Software, Inc. 1992, 2011. All Rights Reserved.

Portions of this software are used with permission and:

- Copyright © 1991-2, RSA Data Security, Inc. All rights reserved.
- Copyright © April 29, 1997 Kalle Kaukonen. All Rights Reserved.
- Copyright International Business Machines, Corp. 1991 All Rights Reserved
- Copyright Lexmark International, Inc. 1991 All Rights Reserved
- Copyright © 1990 Adobe Systems Incorporated. All Rights Reserved
- Copyright © 2006 The FreeType Project (www.freetype.org). All rights reserved.
- Copyright © 1998-2000 Carnegie Mellon University. All rights reserved.
- Copyright © 2002, 2003, 2004 Simon Josefsson
- Copyright © 1998-2006 The OpenSSL Project. All rights reserved.
- Copyright © 1995-1998 Eric Young (eay@cryptsoft.com) All rights reserved.

For additional information see, file RPTMGR/COPYRIGHT.

Appendix D Order Form

Name _____
Company _____
Address _____
City/State/Zip _____
Country _____
Phone _____
Email _____

I have read and agree with the Report Manager Software License Agreement. I am ordering the following licenses:

System Wide License	-- or --	Partition License		
	Proc.		Prt.	Proc.
-- Serial Number ---	Group	-- Serial Number ---	No.	Count
_____	_____	_____	_____	_____
_____	_____	_____	_____	_____
_____	_____	_____	_____	_____

See the Price List for pricing information. The current Price List is available at www.gumbo.com. License price includes one year of maintenance services. Add the amount shown on the price list for each additional year of maintenance services. In Washington state include sales tax (your local rate or 9.5%).

Licenses _____
Maintenance _____
In WA state, add sales tax _____
Total enclosed _____
Signature _____ Date _____
Title _____

Make checks payable to:

GUMBO
Software, Inc.

809 W Howe St
Seattle, WA 98119
United States of America
Phone: 206-284-5078
Email: support@gumbo.com
Web: www.gumbo.com

Rev: 2009/04/14

Appendix E License Agreement

License

Gumbo Software, Inc. grants to the purchaser, permanent license to use Report Manager on the specified serial number and processor group IBM System i. For system licenses the grant is specific to the system as a whole. For partition licenses the grant is specific to a partition number (ID) and maximum processing capacity. This license is not transferable and not exclusive.

Warranty

Gumbo Software, Inc. makes no warranty, either expressed or implied, with respect to Report Manager, its merchantability or its fitness for any particular purpose. Report Manager software and documentation are provided on an "AS IS" basis.

Liability

Gumbo Software, Inc. assumes no responsibility for the use of Report Manager. Purchaser agrees that Gumbo Software, Inc.'s liability under any circumstances shall not exceed the charges paid by purchaser.

Updates

Gumbo Software, Inc. may from time to time update Report Manager to correct defects or add enhancements. Purchaser will receive updates for a period of one year from date of purchase.

Rev: 2001/09/22