

# SpoolMail

Programmer's Guide and Reference  
Licensed Program 2A55SM1 V2R7M0

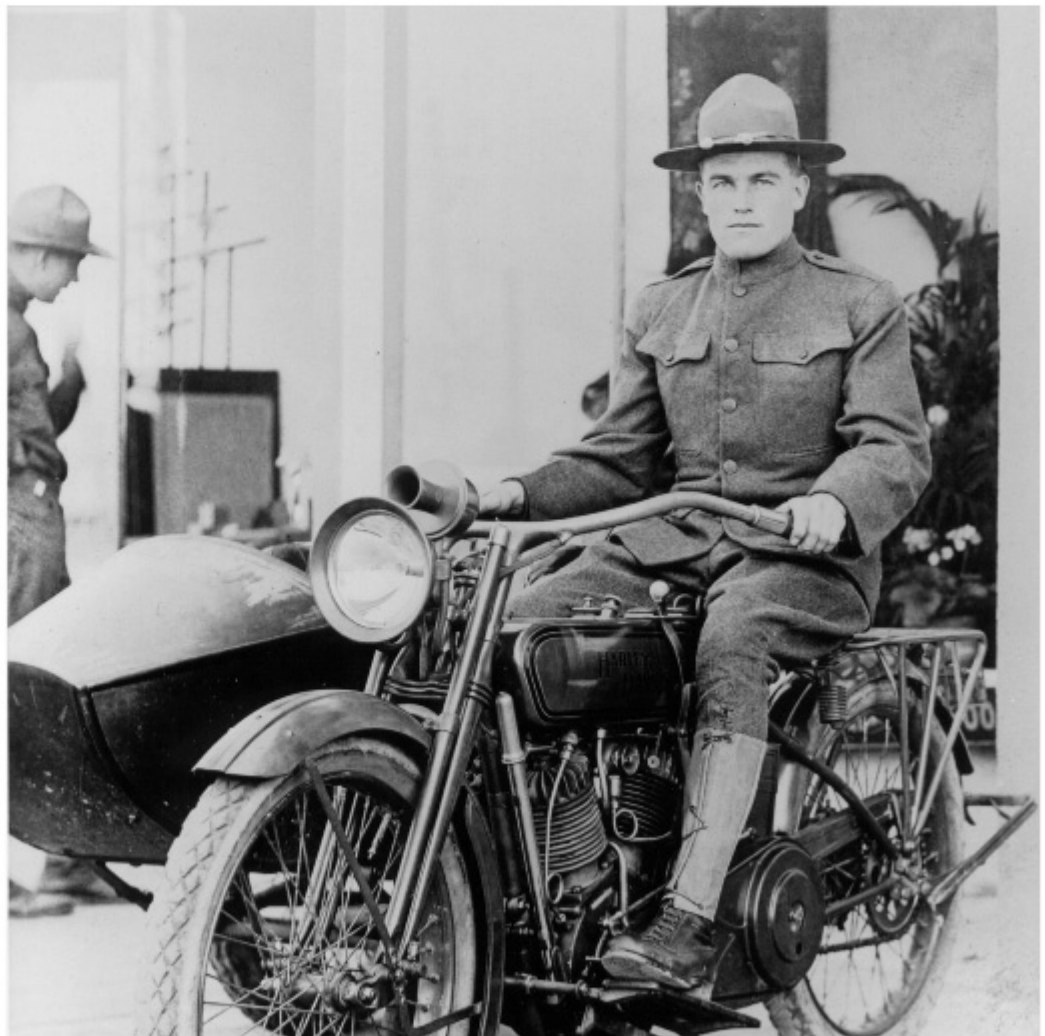

Spooled File Conversion

---

## Edition

### Seventeenth Edition (March 2012)

This edition applies to the licensed program SpoolMail (Program 2A55SM1), Version 2 Release 7 Modification 0, and to all subsequent releases and modifications until otherwise indicated in new editions. This revision makes all previous editions obsolete. Make sure you are using the proper edition for the level of the product.

This manual is available as option 1 from the SPOOLMAIL menu or in PDF format in directory /Gumbo/Proddata/2A55SM1/doc on your System i and on the web.

We welcome your comments. Send them to:

***GUMBO***  
*Software, Inc.*

809 W Howe St  
Seattle, WA 98119  
United States of America  
Phone: 206-284-5078  
Email: support@gumbo.com  
Web: www.gumbo.com

© Copyright Gumbo Software, Inc. 1997, 2012. All Rights Reserved.

---

## Contents

<b>Edition</b> .....	<b>ii</b>	<b>Chapter 5 Implementation</b> .....	<b>31</b>
<b>Contents</b> .....	<b>iii</b>	What's In This Chapter .....	31
<b>Chapter 1 Introduction</b> .....	<b>5</b>	Overview .....	31
What's In This Chapter .....	5	Changing Programs .....	32
SpoolMail Overview .....	5	Manually Sending Email .....	32
SpoolMail Features .....	5	Creating A Gumbo Logical Printer .....	33
SpoolMail Conversions .....	6	Sharing A Gumbo Logical Printer .....	33
SpoolMail's Spooled File Splitting .....	7	Gumbo Logical Printer Authority Adoption .....	34
Logical Printer Support .....	8	Integration With Report Manager .....	34
Standard Product Support Features .....	9	Email Addresses .....	35
Product Positioning .....	9	Adding Line Breaks to the Message .....	37
Future Directions .....	10	Digitally Signing The Message .....	38
Manual Conventions .....	10	Adding User Defined Data .....	38
<b>Chapter 2 Installation</b> .....	<b>11</b>	Useful Spooled File Information .....	38
What's In This Chapter .....	11	Adding Bookmarks To PDF Files .....	39
Installing SpoolMail .....	11	Digitally Signing PDF Files .....	41
Verifying SpoolMail Installation .....	12	CL Coding Tip .....	42
API Authority Granted During Installation .....	13	Changing Command Defaults .....	42
Library List Considerations .....	13	<b>Chapter 6 Conversions</b> .....	<b>43</b>
Release Considerations .....	13	What's In This Chapter .....	43
New Release Testing .....	14	Overview .....	43
Deleting SpoolMail .....	14	ASCII Text .....	44
Additional Installation Information .....	15	Adobe Portable Document Format .....	44
Technical Support .....	15	Microsoft Rich Text Format .....	46
Integrating Report Manager and SpoolMail .....	15	Hyper Text Markup Language .....	47
Hot Site Installation .....	16	Tag Image File Format .....	48
Permanent Authorization Codes .....	16	IBM i Host Print Transform .....	48
<b>Chapter 3 Menu</b> .....	<b>19</b>	No Conversion .....	48
What's In This Chapter .....	19	Adobe PostScript .....	49
Accessing Menu SPOOLMAIL .....	19	IBM's Final Form Text .....	49
SPOOLMAIL Menu Options .....	19	AFP Print File .....	50
<b>Chapter 4 Set Up</b> .....	<b>21</b>	<b>Chapter 7 Commands</b> .....	<b>51</b>
What's In This Chapter .....	21	What's In This Chapter .....	51
Selecting A Quick Start Procedure .....	21	Archive Spooled File (ARCSPLF) .....	52
Quick Start Mail Set Up - Mailhub .....	22	Change Device Gumbo Printer	
Quick Start Mail Set Up - Direct Delivery .....	23	(CHGDEVGLP) .....	54
Using The SMTP Set Up Command .....	24	Change SpoolMail Authorization	
Using The Mailhub Set Up Command .....	24	(CHGSM1AUT) .....	55
Manual Mail Set Up Steps .....	25	Change SpoolMail Default (CHGSM1DFT) .....	57
Additional Mail Set Up Resources .....	30	Check SpoolMail Authorization	
Quick Start - Create A Logical Printer .....	30	(CHKSM1AUT) .....	63
		Create Device Gumbo Printer (CRTDEVGLP)	
		.....	65

Create Spool Save File (CRTSPLSAVF) .....	68
Delete Device Gumbo Printer (DLTDEVGLP) .....	70
Dump Page Index Positions (DMPPIP) .....	71
Display Mail Log (DSPMAILLOG) .....	73
Display Page Data (DSPPAGDTA) .....	75
Extract AFP Resources (EXTAFPRSC).....	79
Restart/Purge Local Mail (INZLOCAL).....	81
Ping SMTP Mail Server (PINGMAIL).....	83
Retrieve Gumbo PTF (RTVGSIPTF) .....	85
Retrieve Page Data (RTVPAGDTA).....	87
Send Spool Mail (SNDSPLMAIL).....	90
Verify Local SMTP (VFYLOCAL).....	111
Verify Mailhub Server (VFYMAILHUB) .....	112
Verify Mail Router (VFYROUTER) .....	114
Work with Gumbo Output Queue (WRKGSIOUTQ).....	116
Work with Gumbo Spooled Files (WRKGSISPLF) .....	117
<b>Chapter 8 Trouble-Shooting .....</b>	<b>119</b>
What's In This Chapter .....	119
General Trouble-Shooting .....	119
Software Installation Problems .....	119
General Mail Delivery Problems .....	120
MSF Specific Delivery Problems.....	123
SMTP Specific Delivery Problems .....	124
PDF File Problems .....	124
Gumbo Logical Printer Problems .....	126
RTF File Problems.....	126
Creating a Spool Save File .....	127
Emailing A Spool Save File .....	127
<b>Appendix A Process Descriptions</b>	<b>129</b>
What's In This Appendix .....	129
SMTP Verification Process.....	129
SMTP Set Up Process .....	130
Mailhub Verification Process .....	132
Mailhub Set Up Process .....	133
<b>Appendix B Record Descriptions .</b>	<b>136</b>
What's In This Appendix .....	136
Display Page Data Record.....	136
<b>Appendix C Notices .....</b>	<b>138</b>
<b>Appendix D Order Form.....</b>	<b>139</b>
<b>Appendix E License Agreement ...</b>	<b>140</b>

---

## Chapter 1 Introduction

---

### What's In This Chapter

This chapter introduces you to SpoolMail. The chapter:

- Gives an overview of SpoolMail.
- Describes the features of SpoolMail.
- Describes the conversions of SpoolMail.
- Describes SpoolMail's spooled file splitting.
- Describes SpoolMail's logical printer support.
- Describes SpoolMail's relationship to other products.
- Outlines future directions for the product.
- Describes conventions used in this manual.

---

### SpoolMail Overview

SpoolMail is an IBM i based software utility that delivers System i spooled output as email. SpoolMail integrates with IBM i's built-in mail support to provide email delivery of printed reports to any email recipient.

SpoolMail allows your users to receive printed reports in a timely, convenient and inexpensive email form. Spooled output from IBM i applications is delivered with a user's regular email ready for on-line viewing and local printing. You reduce costs by avoiding the expense of printing, manual handling and postage associated with printed output. You also avoid the expense of changing your existing IBM i applications to deliver information as email. All processing is performed on the System i, providing a stable platform for generating email.

When sending the email, you have a wide variety of options to tailor the delivered message to your specific needs. Addressing includes multiple recipients, copy recipients and blind copy recipients. Additionally, you can include multiple Reply-to: addresses as well as specify the email address the message appears to come from. Delivery confirmation by read receipt can also be specified. Optionally, a digitally signature can be included with the email.

The product can convert spooled files to a wide variety of formats, the most popular of which is Adobe's Portable Document Format (PDF). The PDF conversion is fully enabled for all levels of document complexity found in IBM i printed output. Print data, page segments, overlays, color, graphics, images, fonts and barcodes are accurately processed to give you PDF files that display and print like the original spooled file. The resulting PDF file is text based (not a bit image), optionally ISO 19005-1:2005 PDF/A compliant and can be searched and indexed using Adobe's products. The PDF files can be encrypted, password protected and compressed during the conversion to provide security and reduce storage requirements. Extensive bookmarking capabilities, based on DDS's indexing keywords or data on the page, allow you to generate PC files that are easy to navigate. Additional parameters allow you to specify the PDF document title, document subject, document open options, and font imbedding, giving fine grain control over the presentation of your data to the end user. The conversion to PDF is DBCS and unicode enabled for Chinese, Japanese, and Korean.

---

### SpoolMail Features

The main function of SpoolMail is accessed by running the Send Spool Mail (SNDSPLMAIL) command. The command takes a spooled file and an email address as input. The spooled file is retrieved from IBM i's spool store and converted to the requested format. The converted spooled file is then sent to the email address entered using IBM i's built-in mail support. IBM i processes the email and either delivers it directly to the recipient(s) or forwards it to a mail router for delivery.

Some additional mail features of SpoolMail are:

- Extensive ability to convert spooled files to PC files including the ability to split a spooled file into multiple emails based on data on the page.
- Additional documents can be included with the generated email.

- User exit available for supplying the recipient's email address from data, such as customer number, on the page.
- Support for distribution lists via the IBM i system distribution directory.
- Support for direct delivery to SMTP clients without IBM i system distribution directory entry.

Commands to help you trouble shoot and, optionally, automatically configure IBM i to send mail are also included with SpoolMail.

Our Display Page Data (DSPPAGDTA) command is included in the product. The command allows you to display selected data from within a spooled file. The command supports output to a display, to print, and most interestingly to an output file. For example, by displaying the page positions of the customer number in spooled files containing invoices, you can create an index from customer number to the related spooled files that contain their invoices.

Our Retrieve Page Data (RTVPAGDTA) command is included in the product. The command allows you to retrieve data from a specific position spooled file. The requested data is returned in a Control Language (CL) program variable.

For example, by retrieving the page position of the customer number in a spooled file containing an invoice, you can determine the customer number for which the invoice was generated from within a CL program.

SpoolMail includes a work-a-like for IBM i's Work with Spooled File (WRKSPLF) command called Work with Gumbo Spooled Files (WRKGSISPLF). It also includes a work-a-like for IBM i's Work with Output Queue (WRKOUTQ) command called Work with Gumbo Output Queue (WRKGSIOUQ). These commands provide the same functions as their IBM i equivalent. In addition they provide an option that allows you to access the function of SpoolMail by entering an option number.

SpoolMail includes a command and associated print driver programs that allow you to create logical printer devices. Logical printers perform SpoolMail's spooled file processing automatically for all spooled files placed on their output queue.

---

## SpoolMail Conversions

SpoolMail supports all of the IBM i spooled file print data streams:

- \*SCS (SNA Character String)
- \*IPDS (Intelligent Printer Data Stream)
- \*AFPDS (Advanced Function Presentation Data Stream)
- \*USERASCII (ASCII data stream)
- \*LINE (1403 line data)
- \*AFPDSLINE (Mixed \*AFPDS and \*LINE data)

SpoolMail can produce PC files in a wide variety of industry standard formats:

- Adobe's Portable Document Format (PDF)
- ASCII text (TXT)
- Microsoft's Rich Text Format word processor file (RTF)
- The world wide web's Hyper Text Markup Language (HTML)
- Printer specific print data streams produced by IBM i's Host Print Transform (HPT)
- An unaltered copy of the original print data stream (NONE)
- Adobe's PostScript (PS)
- IBM's AFP Print File (AFP)
- IBM's Final Form Text (FFT)
- Tag Image File Format (TIFF)

Not all of the possible conversions are applicable to all spooled file print data streams. The following table shows the supported conversions:

Figure: Print Data Stream/Conversion Matrix

Input Spooled File Print Data Stream	Output Data Format Conversion								
	PDF	TXT	RTF	HTML	HPT	NONE	PS	FFT	TIFF
*SCS	YES	YES	YES	YES	YES	YES		YES	YES
*IPDS	YES	YES	YES	YES		YES		YES	
*AFPDS	YES	YES			YES	YES	YES		YES
*USERASCII						YES			
*LINE	note	note			note	YES	note		note
*AFPDSLINE	note	note			note	YES	note		note

Notes: o Print Data Stream is found on WRKSPLFA's "Printer device type" parameter. Use option 8 from WRKOUTQ or WRKSPLF.  
o PDF is double byte enabled for Chinese/Japanese/Korean.  
o TXT is double byte enabled for \*SCS.  
o Convert \*LINE and \*AFPDSLINE to \*AFPDS using OVRPRTF CVTLINDTA(\*YES) or respool using CRTAFPDTA/PRTAFPDTA.

The conversion process is described in detail in the Conversions chapter.

---

## SpoolMail's Spooled File Splitting

SpoolMail has the ability to split spooled files into multiple emails based on data found on each page. A request to split the spooled file is indicated by specifying the \*PAGDTA special value as the recipient on the Send Spool Mail (SNDSPLMAIL) command. When splitting is indicated, the location of the data used is specified on the Page data (PAGDTA) parameter.

The data for each page is retrieved and pages with identical values are converted into a PC file and emailed. If the page data is not an email address but other identifying information, the Address mapping program (ADDMAPPGM) parameter specifies a customer supplied program to calculate an email address based on the data on the page.

Figure: 3 Page Spooled File

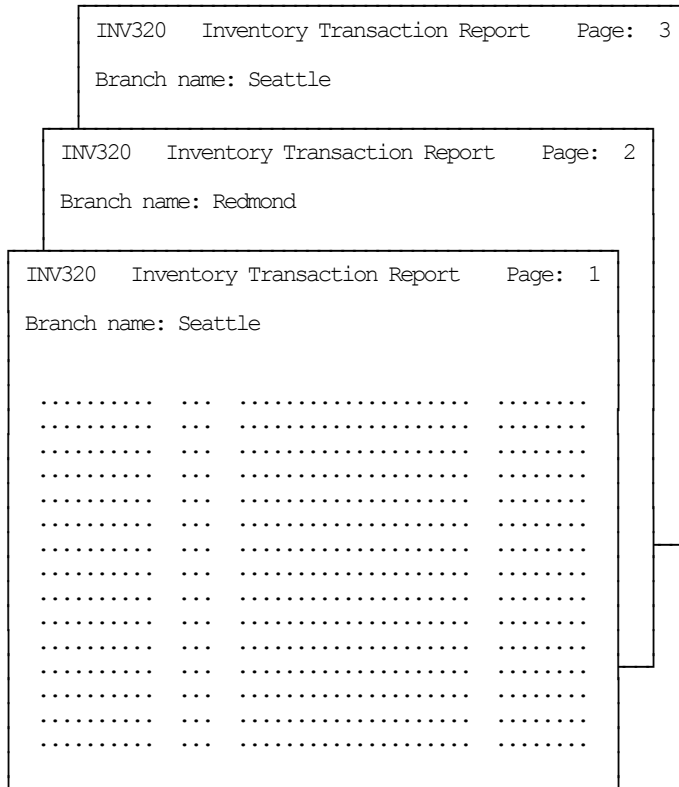

For example, consider a 3 page spooled file with a 10 character branch name printed at line 3, position 15 of each page. Also consider an address mapping program that retrieves the email address of a branch manager based on the name of the branch. If pages 1, and 3 contain "Seattle" and pages 2 contains "Redmond" then the following command generates two emails:

```
SNDSPLMAIL  TOSMTPNAME (*PAGDTA)  PAGDTA(3 15 10)
             ADDMAPPGM(QGPL/BRCH2MGR)  ...
```

The first, sent to the manager of the "Seattle" branch, contains page 1, and 3 while the second, sent to the "Redmond" branch manager, contains pages 2.

The \*PAGDTA special value is enabled for APF FFT HTM PDF RTF TIF and TXT conversions. For additional information see the Send Spool Mail (SNDSPLMAIL) command's help text. A skeleton address mapping program written in CL is included in the file SMSOURCE, member SKLADDMAP.

---

## Logical Printer Support

A Gumbo logical printer is a printer device that performs spooled file processing instead of printing on paper. As with other printer devices, you use IBM i's writer commands (WRKWTR, STRPRTWTR, ENDWTR, HLDWTR, etc.) and IBM i's configuration commands (WRKCFGSTS, VFYCFG, etc.) to control a Gumbo logical printer's operation.

When you create a Gumbo logical printer using the Create Device Gumbo Printer (CRTDEVGLP) command, a source file with the same name is create in library QUSRSYS. The source file contains a member with the same name as the printer and in the source member is a single Control Language (CL) command. As a Gumbo logical printer processes, it runs this command once for each spooled file in the output queue.

Logical printers can be shared to your network and provide direct emailing from any PC application for any PC on your network. Combine this with SpoolMail's PDF support and you can email PDF files without Acrobat.



---

## Standard Product Support Features

**GUMBO** products include a range of standard features that make them easy to use, easy to manage, and easy to live with:

- Extensive manual, both online as menu option 1 and in PDF
- Context sensitive help for every command and parameter.
- Menu that provides organized access to the product's features.
- Products are packaged as licensed programs and participates in the full range of support provided by IBM i Licensed program installation, PTF management, etc. are handled with the same commands used to manage IBM® software.
- Unlike IBM® Licensed Programs, our products are packaged to allow multiple releases to be installed at the same time, which facilitates new release testing.
- Product PTFs are available on the web at [www.gumbo.com](http://www.gumbo.com).
- Our products include a hot site friendly automatic authorization function that allows you to immediately move operations to any back up or fail over machine without contacting us for a license key or authorization code.
- We include a Check SpoolMail Authorization (CHKSM1AUT) command that allows you to exercise the product's authorization algorithm and insure there are no authorization "surprises".
- An installation verification option is available on the menu. You can easily verify that the product is correctly installed.
- All (applicable) objects in our products are digitally signed allowing you to verify their integrity. Modifications that could jeopardize the security of your system are easily detected with IBM i's Check Object Integrity (CHKOBJITG) command.
- Our products are upward compatible with future releases of IBM i. You can install a new releases of IBM i without installing a new release from us.
- Our products are compatible with all IBM i security levels. We use only published interfaces.

---

## Product Positioning

Gumbo Software, Inc. has several IBM i based products:

<b>Number</b>	<b>Licensed Program</b>
<b>2A55RM1</b>	Report Manager - Automates report distribution, bursting and spooled file management
<b>2A55SM1</b>	SpoolMail - Converts IBM i spooled files into industry standard file formats and sends the resulting PC files to any email recipient
<b>2A55SAM</b>	Spool-a-Matic - Converts IBM i spooled files into industry standard file formats and places the resulting PC files in the Integrated File System
<b>2A55XL1</b>	Excel-erator - Converts database files into spreadsheets placing the resulting PC files in the Integrated File System or sends the resulting PC files to any email recipient
<b>2A55DCR</b>	Dicer - Merges/sorts/splits/duplicates spooled files
<b>2A55RDA</b>	Report Designer - Edits DDS, RPG and ILE/RPG print specifications
<b>2A55SM2</b>	Gumbo Mail - Sends email from your applications

There is some overlap between and unique function within the products. Choose the product or combination of products that provide the function you need:

Function	Product						
	RML	SML	SAM	XL1	DCR	RDA	SM2
Primary input to product	SPL	SPL	SPL	DBF	SPL	SRC	IFS
Primary output from product	SPL	EML	IFS	I/E	SPL	SRC	EML
Monitor output queues for work	YES	YES	YES	—	—	—	—
Spooled file distribution	YES	—	—	—	—	—	—
Burst (split) spooled files	YES	YES	YES	—	YES	—	—
Merge/sort/duplicate spooled files	YES	—	—	—	YES	—	—
Convert spool to TXT PC file	YES	YES	YES	—	—	—	—
Convert spool to PDF/RTF/etc. PC file	—	YES	YES	—	—	—	—
Convert DB file to spreadsheet	—	—	—	YES	—	—	—
Email PC file as attachment	YES	YES	—	YES	—	—	YES
Write PC file to Integrated File System	YES	—	YES	YES	—	—	—
Set up IBM i SMTP & mailhub	YES	YES	—	YES	—	—	YES
Edit DDS, RPG, ILE/RPG source code	—	—	—	—	—	YES	—
Where: DBF = Database file EML = Email IFS = PC file in the Integrated File System I/E = Both IFS and EML SPL = Spooled file SRC = Source code							

---

## Future Directions

Future releases of SpoolMail will include enhanced functionality based on customer feedback. Additionally, enhancements are often added to a current release by Program Temporary Fix (PTF).

Contact **GUMBO** to suggest additional enhancements.

---

## Manual Conventions

A note on conventions used in this manual. In several places, instructions for entering commands are given. When the command is intended to be run from a PC command prompt, it is flagged by `[PC]`. When the command is intended to be run from an IBM i command line, it is flagged by `[i]`, or is not flagged at all. `[Enter]` denotes the enter key.

---

## Chapter 2 Installation

---

### What's In This Chapter

This chapter describes:

- How to install SpoolMail.
- How to verify that SpoolMail is installed correctly.
- API authority granted during installation
- How to include the SPOOLMAIL library in a job's library list.
- How to determine release dependencies.
- How to test a new release while leaving the old in production.
- How to remove SpoolMail from the system.
- How to find additional installation information.
- How to contact technical support.
- How to integrate Report Manager and SpoolMail.
- Hot site installation.
- Permanent Authorization Codes.

---

### Installing SpoolMail

Follow these instructions to install SpoolMail V2R7M0 on your System i:

#### Prepare

If you are upgrading a previous release (if SpoolMail is currently installed on your System i) perform these steps before installing the software:

1. Read the Enhancement Summary to determine if any changes affect your installation.
2. Insure that the product is not in use, as the installation process must clear the product's library. This will fail if objects such as menus are in use. If the installation fails, the previous release will be restored.

#### Install

**Note:** If you have downloaded this software from the web, instructions specific to installing from the download can be found in the file "readme.htm" which was included.

1. Sign on to the system as the security officer (QSECOFR).
2. Verify that your machine is at IBM i V6R1M0 or later by running:

```
DSPDTAARA DTAARA (QGPL/QSS1MRI)
```

**Note:** If you are running a version of IBM i earlier than V6R1M0 you cannot install SpoolMail V2R7M0 on your machine. You must install an earlier version of SpoolMail or upgrade the operating system.

3. Verify that user domain objects are allowed in the libraries SPOOLMAIL and QSRV, by running:

```
WRKSYSVAL SYSVAL (QALWUSRDMN)
```

Take option 5 to display the value. If the value is not \*ALL, use option 2 to add libraries SPOOLMAIL and QSRV to the list of libraries where user domain objects are allowed.

**Note:** QSRV is required to correctly process PTFs when they are loaded and applied.

4. Insure that IBM i will be able to verify the signatures that we apply to our product's objects by installing our Signing Certificate and Root CA Certificate using Digital Certificate Manager. Alternately, insure that signature verification will not prevent the restore operation by running:

```
WRKSYSVAL SYSVAL(QVfyOBRST)
```

Take option 5 to display the value. If the value is 3 or higher, use option 2 to temporarily change the value to 1.

5. Mount the distribution media in the appropriate device.
6. Submit the Restore Licensed Program (RSTLICPGM) command to batch:

```
RSTLICPGM LICPGM(2A55SM1) DEV(device-name) LNG(2924)
```

**Note:** Where "device-name" is the device the media was mounted on and is usually OPT01.

**Note:** During the restore operation, the system operator message queue may receive inquiry message CPA3DE4 "Directory not registered. (C G)". Unless you are using a directory naming convention similar to ours (that is the directory specified in the CPA3DE4's second level text is unrelated to our software), you can safely respond with a "G" to reestablish the relationship between the directory and the product. Typically, the message will occur three times.

## Finish

When the RSTLICPGM command completes, library SPOOLMAIL and directory '/Gumbo/ProdData/2A55SM1' contain the new software. To complete the installation:

1. If you have an Authorization letter with your permanent authorization code, enter it now.

**Note:** SpoolMail automatically grants 30 days usage for new installs or 90 days usage for release upgrades.

2. Retrieve the current cumulative PTF package by running the following command:

```
SPOOLMAIL/RTVGSIPTF
```

**Note:** **GUMBO** recommends downloading the current cumulative PTF package from [www.gumbo.com](http://www.gumbo.com) after installing the software.

3. You can access the SpoolMail menu by running the following command:

```
GO MENU(SPOOLMAIL/SPOOLMAIL)
```

---

## Verifying SpoolMail Installation

You can verify that SpoolMail has been correctly installed by running the Check Product Option (CHKPRDOPT) command:

```
CHKPRDOPT PRDID(2A55SM1) RLS(V2R7M0) CHKSIG(*NONE)
```

**Note:** If you have installed our digital certificates, specify CHKSIG(\*ALL) instead of CHKSIG(\*NONE) and digital signatures will be checked.

If the message 'No errors detected by CHKPRDOPT.' is displayed on the bottom of your display when the command finishes, SpoolMail is installed correctly.

If the message is not displayed, check your job log messages or see the Recovery Procedures in the *Software Installation Problems* section of the *Trouble-Shooting* chapter of this manual.

---

## API Authority Granted During Installation

The first time SpoolMail is installed on a system, public authority \*USE is granted to 3 of the IBM i supplied spooling APIs. These are QSPOPNSP, QSPGETSP, and QSPCLOSP. The APIs are used by SpoolMail to open, read and close spooled files. This is required to perform the product's functions.

Security restrictions and authority requirements pertaining to spooled files and output queues remain in effect and are enforced by IBM i during use of the APIs. However, if you are operating a highly secured environment you may wish to review and revise the authority granted during installation.

No authority is granted during installation if SpoolMail exists on the system. This prevents new releases from altering changes made after the initial installation.

---

## Library List Considerations

Library SPOOLMAIL must be in the library list of jobs using SpoolMail commands, or the commands must be qualified with library SPOOLMAIL. Depending on your installation and intended use, you can choose to:

- Add library SPOOLMAIL to the system library list. This insures every job in the system has access to SpoolMail commands. However, this introduces problems with installing new releases and is not recommended.
- Add library SPOOLMAIL to the initial library list parameter of job descriptions controlling jobs that will use SpoolMail commands. (recommended)
- Run an ADDLIBLE SPOOLMAIL command in individual threads requiring SpoolMail commands.
- Qualify the command names on each use:

```
SPOOLMAIL/CHGSM1DFT
```

Library SPOOLMAIL will be temporarily added to the product portion of the current thread's library list.

Determine the best method for your installation and perform any changes required.

---

## Release Considerations

SpoolMail operates under IBM i V6R1M0 or higher. Releases occur on a different schedule than IBM releases. Once SpoolMail is installed, the following considerations apply:

- A new release of IBM i may be installed without installing a new release of SpoolMail.

SpoolMail uses only published or IBM sanctioned interfaces and is upward compatible with all releases of IBM i. The SpoolMail authorization code does not change.

- A new release of SpoolMail may be installed without installing a new release of IBM i.

Any change in the requirements for operating system release level will be noted in the documentation accompanying the SpoolMail release. The new authorization code must be entered.

- A new release of SpoolMail may be installed over any prior release of SpoolMail.

You can skip "missed" releases.

- More than one release of SpoolMail may be installed on a system at one time.

By restoring SpoolMail to a library other than SPOOLMAIL, a new release can be installed for testing while the old release remains in production. Any release-to-release considerations that may

apply will be noted in the documentation accompanying the new release. Additional operational considerations may apply. For more information on renaming a library during licensed program installation, see the Restore Licensed Program (RSTLICPGM) command and the New Release Testing section of this chapter.

- When a new release of SpoolMail is installed in the same library as an old release the following processing is performed in order to preserve data and SpoolMail authorization information:
  1. The SpoolMail library is saved to QGPL/SM1VxRyMz. Where VxRyMz is the old release.
  2. Product objects that contain default settings and operational information are copied to library QTEMP.
  3. The SpoolMail library is cleared.
  4. SpoolMail is restored.
  5. Default settings and operational information are copied back to the product objects.
  6. All objects duplicated to QTEMP are deleted.
  7. Save file QGPL/SM1VxRyMz is deleted.

**Note:** **GUMBO** recommends making a backup of the old release before installing a new release of SpoolMail.

---

## New Release Testing

Unlike IBM licensed programs, **GUMBO** licensed programs are packaged in a way that allows multiple release to be installed on your System i at the same time. This feature allows you to test a new release while the old release remains in production.

The key to new release testing are the LIB() and CODHOMEDIR() parameters of IBM i's Restore License Program (RSTLICPGM) command which allow you to restore the product to a library name and directory different from those used during packaging.

To test a new release, follow this procedure:

1. Review the Enhancement Summary for any release-to-release considerations that could affect your installation.
2. Install the new release in library SM1V2R7M0 and directory '/Gumbo/ProdData/2A55SM1V2R7M0':

```
RSTLICPGM LICPGM(2A55SM1) DEV(device-name) LNG(2924)
          LIB(SM1V2R7M0) REPLACERLS(*NO)
          CODHOMEDIR('/Gumbo/ProdData/2A55SM1V2R7M0')
```

Where device-name is the device the media was mounted on.

3. Perform your new release testing.
4. When testing is complete, you must delete the new release.

```
DLTLICPGM LICPGM(2A55SM1) RLS(V2R7M0) OPTION(*ALL)
```

**Note:** Do not delete nor rename libraries and directories to move the new release into production. Doing so will corrupt the license program information kept internally by IBM i. If this has already occurred, see the Software Installation Problems section of the *Trouble-Shooting* chapter of this manual.

5. Follow the installation instructions to place the new release into production.

---

## Deleting SpoolMail

Follow these instructions to remove SpoolMail from your System i:

1. Sign on to the system as the security officer (QSECOFR).
2. Delete the SpoolMail library by using the Delete Licensed Program (DLTLICPGM) command:

```
DLTLICPGM LICPGM(2A55SM1) OPTION(*ALL)
```

These instructions delete an otherwise healthy installation of SpoolMail. If the installation has been damaged, follow the instructions for Installation Fails in the *Software Installation Problems* section of the *Trouble-Shooting* chapter of this manual.

---

## Additional Installation Information

Additional detailed installation information and instructions can be found in *IBM i and related software > PDF file... > Installing, upgrading, or deleting IBM i and related software SC41-5120* topic in the IBM i Information Center at <http://publib.boulder.ibm.com/series/>.

---

## Technical Support

If you encounter a problem with SpoolMail you should:

- Review the information in the Trouble Shooting chapter for a description of and solution to common problems.
- Load and apply the current cumulative PTF package for the software. You can obtain the current package by visiting the web site listed below.

If the problem remains unresolved, contact [support@gumbo.com](mailto:support@gumbo.com).

If your problem involves spooled file processing, the best method for getting it resolved is to capture the spooled file using the Create Spool Save File (CRTSPLSAVF) command and email the resulting save file along with a description of the problem to the address listed above. Be sure to include contact information.

**Note:** See the Trouble Shooting chapter for details on creating and sending spool save files.

---

## Integrating Report Manager and SpoolMail

Report Manager is a product that offers extensive spooled file manipulation capabilities, including the ability to deliver spooled files as email. The email delivery is limited however to plain ASCII text attachments and does not include the extensive conversion capabilities offered by SpoolMail.

SpoolMail is a product that offers extensive spooled file emailing capabilities, but does not provide spooled file splitting, and other capabilities offered by Report Manager.

To make the capabilities of SpoolMail available for use with Report Manager perform the following step:

1. Change the Report Manager job description RMRPTWTR to include library SPOOLMAIL on the Initial library list (INLLIBL) parameter. For example, if you are using the job description as shipped with Report Manager, run the following command:

```
CHGJOB JOB (RPTMGR/RMRPTWTR)
        INLLIBL(RPTMGR QTEMP QGPL SPOOLMAIL)
```

2. Add subscriptions to the reports that should email spooled files using SpoolMail. For example, to email PC files as Portable Document Format from report INV310 to RMT1 SYS1, run the following command:

```
ADDRPTSUB RPT(REPORTS/INV310) USER(*USRID)
           USRID(RMT1 SYS1) OUTQ(*NONE)
           SNDFMT(*EMAIL) TRANSFORM(*PDFLETTER)
```

---

## Hot Site Installation

In the event of a catastrophic system failure, an otherwise properly licensed and authorized copy of our product may be copied to a back up or fail over machine. The product's authorization algorithm will detect that the software is operating on a machine serial number different from the licensed and authorized serial number and automatically create and install a 30-day temporary authorization code for the back up or fail over machine. You do not need to contact Gumbo Software, Inc. in the event of an emergency.

An otherwise properly licensed and authorized copy of this product may be transferred to a back up or fail over machine for the purpose of testing your emergency recovery procedures and the product's automatic temporary authorization function.

The correct sequence of steps is as follows:

1. Install the software and enter the permanent authorization code on your production machine.
2. Save the software from your production machine using the Save Licensed Program (SAVLICPGM) command. This creates an authorized copy, save it with your back ups.
3. When restoring to the back up or fail over machine you must first insure that any previous copies have been deleted. To delete a previous copy use the Delete Licensed Program (DLTLICPGM) command.
4. Restore the authorized copy to the back up or fail over machine using the Restore License Program (RSTLICPGM) command.
5. Confirm that the authorized copy was correctly restored by running the Check Product Option (CHKPRDOPT) command.
6. The first time the software is used on the back up or fail over machine the product's authorization algorithm will create and install a temporary authorization code running for 30 days. This allows you install the authorized copy in advance of a disaster.

---

## Permanent Authorization Codes

When you purchase a product from us, or when we send you a new release of a product, you receive a permanent authorization code. Here we describe how to determine the information you must give us in order to receive a permanent authorization code and how to determine if the permanent authorization code you have received is correct for your installation.

The overwhelming majority of licenses purchased from us are **System Wide Licenses**. The other possibility, a **Partition Only License**, is described at the end of this section. For a System Wide License, permanent authorization codes are specific to a **Serial Number**, a **Processor Group**, and our product's **Release**. For a Partition Only License, permanent authorization codes are specific to a **Serial Number**, a **Partition ID Number**, the partition's **Maximum Processor Capacity**, and our product's **Release**.

In all cases, our permanent authorization codes are specific to a release of our product. The release of IBM i never makes a difference. To determine the release of our product installed on your System i, run:

```
DSPPTF LICPGM(2A55SM1)
```

Where the possible LICPGM numbers are:

Number	Licensed Program
<b>2A55RM1</b>	Report Manager - Automates report distribution, bursting and spooled file management
<b>2A55SM1</b>	SpoolMail - Converts IBM i spooled files into industry standard file formats and sends the resulting PC files to any email recipient
<b>2A55SAM</b>	Spool-a-Matic - Converts IBM i spooled files into industry standard file formats and places the resulting PC files in the Integrated File System
<b>2A55XL1</b>	Excel-erator - Converts database files into spreadsheets placing the resulting PC files in the Integrated File System or sends the resulting PC files to any email recipient
<b>2A55DCR</b>	Dicer - Merges/sorts/splits/duplicates spooled files
<b>2A55RDA</b>	Report Designer - Edits DDS, RPG and ILE/RPG print specifications
<b>2A55SM2</b>	Gumbo Mail - Sends email from your applications



The 5th line of the panel shows the release you are running. It is V2R7M0 in this example.

```

                                Display PTF Status
                                System:  GUMBO4
Product ID . . . . . : 2A55SM1
IPL source . . . . . : ##MACH#A
Release . . . . . : V2R7M0

Type options, press Enter.
  5=Display PTF details  6=Print cover letter  8=Display cover letter

      PTF
Opt ID      Status
(No PTFs found.)

                                IPL
                                Action

                                Bottom
F3=Exit  F11=Display alternate view  F17=Position to  F12=Cancel

```

**Note:** It is possible that more than one release of a product is installed. To check, press <Enter>. If you are returned to the command line, only one release is installed.

All of our permanent authorization codes are serial number dependent. For a System Wide License they are also Processor Group dependent. To determine your system's serial number and processor group, run:

WRKPLICINF

Lines 3 and 4 of the resulting panel show the serial number and processor group of your system.

```

                                Work with License Information
                                GUMBO4
                                04/06/10 18:08:32
System serial number . . . . . : 1234567
Processor group . . . . . : P10

Type options, press Enter.
  1=Add license key  2=Change  5=Display detail  6=Print detail
  8=Work with license users ...

      License
Opt Product  Term  Feature  Description
---
5761SS1 V6R1M0  5050  IBM i
5761SS1 V6      5051  IBM i
5761SS1 V6R1M0  5103  Media and Storage Extensions
5761SS1 V6R1M0  5112  PSF 1-45 IPM Printer Support
5761SS1 V6R1M0  5113  PSF 1-100 IPM Printer Support
5761SS1 V6R1M0  5114  PSF Any Speed Printer Support
5761SS1 V6R1M0  5116  HA Switchable Resources
More...

Parameters or command
===>
F3=Exit      F5=Refresh  F11=Display Usage Information  F12=Cancel
F17=Position to  F23=More options
(C) COPYRIGHT IBM CORP. 1980, 2007.

```

For a Partition Only License, permanent authorization codes depend on the Partition ID Number and maximum processor capacity. To determine the number and processor capacity of partitions on your system:

1. Start system service tools by running:

STRSST

2. After entering a Service tools user ID and Service tools password, select the option to Work with system partitions.
3. Select the option to Display partition information.
4. Select the option to Display partition processing configuration.
5. Note the Partition ID Number and Total Processor Maximum.

```

Display Partition Processing Configuration
System: GUMBO4
Number of system processors . . . . . : 2
Number of available system processors . . . . . : 0
Size of system main storage (MB) . . . . . : 4096
Size of available system main storage (MB) . . . . . : 0
Interactive feature available . . . . . : 0 %

Partition -----Total Processors-----
Identifier Name Current / Pending Minimum / Maximum
0 PRIMARY 1 / 1 1 / 1
1 SECONDARY 1 / 1 1 / 1

F3=Exit F5=Refresh F6=Print F10=Main storage
F11=Display allocated I/O resources F12=Cancel

```

**Note:** A Partition only license is not valid for a machine with only one partition.

**Note:** Our product's algorithm checks the authorization against the Total Processors Current value. If the maximum configured is larger than the license, the algorithm will grant usage as long as the current configured is with in the license's limit, and will issue a warning.

---

## Chapter 3 Menu

---

### What's In This Chapter

This chapter describes how to access the SpoolMail menu, and reviews the functions that can be performed from the menu.

---

### Accessing Menu SPOOLMAIL

The SpoolMail commands and functions that you will use most often are collected on menu SPOOLMAIL. To access the menu use the Go To Menu (GO) command:

```
GO MENU (SPOOLMAIL/SPOOLMAIL)
```

Library SPOOLMAIL is added to the product portion of the current thread's library list while the menu is displayed.

---

### SPOOLMAIL Menu Options

The SPOOLMAIL options are:

```
SPOOLMAIL                               SpoolMail                               System:  SM1

Select one of the following:

      1. Reference Manual

SpoolMail
      2. Send Spool Mail                               SNDSPLMAIL
      3. Work with Gumbo Spooled Files                 WRKGSISPLF
      4. Work with Gumbo Output Queue                 WRKGSIOUQ

Verification and Set Up
      10. Verify the product is installed correctly    CHKPRDOPT
      11. Mail Verification And Set Up Menu
      12. Create Device Gumbo Printer                 CRTDEVGLP
      13. Change Device Gumbo Printer                 CHGDEVGLP
      14. Delete Device Gumbo Printer                 DLTDEVGLP

More...

Selection or command
===>

F3=Exit  F4=Prompt  F9=Retrieve  F12=Cancel
© Copyright Gumbo Software, Inc. 1997, 2012. All Rights Reserved.
```

#### Option 1. Reference Manual

Provides access to the SpoolMail Programmer's Guide and Reference Manual.

#### Option 2. Send Spool Mail

The Send Spool Mail (SNDSPLMAIL) command converts an IBM i spooled file and sends it as email to a recipient.

#### Option 3. Work with Gumbo Spooled Files

The Work with Gumbo Spooled Files (WRKGSISPLF) command works like IBM i's Work with Spooled Files (WRKSPLF) command but provides additional options to access the functions of SpoolMail.

#### Option 4. Work with Gumbo Output Queue

The Work with Gumbo Output Queue (WRKGSIOUQ) command works like IBM i's Work with Output Queue (WRKOUTQ) command but provides additional options to access the functions of SpoolMail.

#### Option 10. Verify the product is installed correctly

Installation verification checks to make sure that SpoolMail has been correctly installed by running IBM i's Check Product Option (CHKPRDOPT) command.

### **Option 11. Mail Verification And Set Up Menu**

The Mail Verification And Set Up menu provides commands to help you set up mail on your system and verify that it is operating correctly.

### **Option 12. Create Device Gumbo Printer**

The Create Device Gumbo Printer (CRTDEVGLP) command creates a device description for a Gumbo logical printer.

### **Option 13. Change Device Gumbo Printer**

The Change Device Gumbo Printer (CHGDEVGLP) command prompts you to change the source command executed by a Gumbo logical printer.

### **Option 14. Delete Device Gumbo Printer**

The Delete Device Gumbo Printer (DLTDEVGLP) command deletes a device description for a Gumbo logical printer.

### **Option 61. Display Current PTF Status**

Displays the SpoolMail PTFs that have been applied to the software.

### **Option 62. Change SpoolMail Authorization**

The Change SpoolMail Authorization (CHGSM1AUT) command changes the authorization code for SpoolMail. The command is used to extend a demonstration period or to permanently authorize SpoolMail for a system or a partition.

### **Option 63. Search Help Index**

Search help index allows you to access the SpoolMail help index and search for specific information.

### **Option 64. Change SpoolMail Default**

The Change SpoolMail Default (CHGSM1DFT) command changes values used by SpoolMail to control processing and other activities.

### **Option 65. Dump Page Index Positions**

The Dump Page Index Positions (DMPPIP) command prints the line and position values, for data found in the spooled file, as calculated by the software. These are used to specify data selection criteria for the spooled file.

### **Option 66. Create Spool Save File**

The Create Spool Save File (CRTSPLSAVF) command creates a save file containing a spooled file and all its related resources. The save file is suitable for emailing with a problem report.

### **Option 67. Display Page Data**

The Display Page Data (DSPPAGDTA) command shows the contents of a spooled file's pages at specified locations. The contents can be shown, printed, or directed to database output file (OUTFILE).

### **Option 68. Retrieve Page Data**

The Retrieve Page Data (RTVPAGDTA) command retrieves data from a specific location in a spooled file. The requested data is returned in a Control Language (CL) program variable.

### **Option 69. Check SpoolMail Authorization**

The Check SpoolMail Authorization (CHKSM1AUT) command executes SpoolMail's authorization verification function. This allows you to determine whether and how the product is authorized for use.

### **Option 70. Retrieve Gumbo PTF**

The Retrieve Gumbo PTF (RTVGSIPTF) command checks a remote system for new product PTFs, and, if available, downloads and installs them.

---

## Chapter 4 Set Up

---

### What's In This Chapter

This chapter provides information on setting up your system to use SpoolMail. The chapter describes:

- How to select a quick start mail set up procedure.
- Quick start mail set up - Mailhub.
- Quick start mail set up - Direct Delivery.
- How to use the Verify Local SMTP (VFYLOCAL) command.
- How to use the Verify Mailhub Server (VFYMAILHUB) command.
- Manual mail set up steps
- Additional mail set up resources.
- Quick start - create a logical printer.

---

### Selecting A Quick Start Procedure

SpoolMail creates email by constructing a MIME formatted message and passing it to IBM i for processing and delivery. If your System i is already configured for email delivery, no additional set up is needed and you can skip this chapter. If SpoolMail is the first application on the System i to generate email for delivery, there are IBM i configuration changes you must perform. SpoolMail includes a Mail Verification And Set Up menu (GO SPOOLMAIL/MAILSETUP) that provides tools to help you make them.

However, the scope of this chapter is limited. If any of the following apply to your installation, proceed directly to the Additional Mail Set Up Resources section for references to help in configuring IBM i:

- Domino for IBM i is installed on the system.
- Multiple TCP/IP interfaces (other than \*LOOPBACK) are configured.
- Multiple email domains require support.

There are two quick start mail set up procedures for configuring IBM i mail services described in this chapter. The procedures are:

- Quick start mail set up - Mailhub
- Quick start mail set up - Direct Delivery.

You only perform, at most, one of these. To select the correct procedure consider the following simplified configurations:

Figure: Mail Configurations

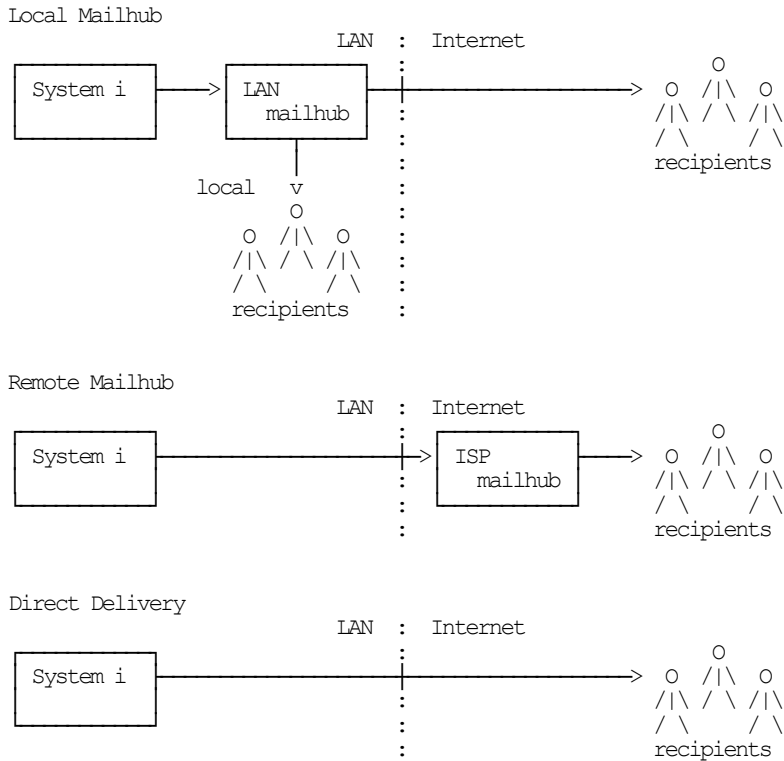

For most customers the System i is attached to a local area network that also has a mail server attached to it. Typically, the mail server runs on a PC with Exchange, Domino, SendMail, or similar mail application installed. In addition, typically, this mail server should be responsible for delivering mail, and will server as the forwarding mailhub server for the System i. If this is your situation, proceed to the Quick Start Mail Set Up - Mailhub section.

For some customers, the mail server belonging to their internet service provider (ISP) is used to deliver email. If this is your situation, proceed to the Quick Start Mail Set Up - Mailhub section.

If you do not have a mail server capable of serving as a mailhub, or do not have access to an ISP's server, you must configure your System i to deliver email directly. Proceed to the Quick Start Mail Set Up - Direct Delivery section.

## Quick Start Mail Set Up - Mailhub

To configure your System i to use a forwarding mailhub server follow these steps. If any of the steps fail, move on to the detailed sections of this chapter.

1. Install SpoolMail on your System i (see the Installation chapter for details).
2. Display the main menu (GO SPOOLMAIL/SPOOLMAIL).
3. Run the option to verify that SpoolMail is installed correctly.
4. Display the Mail Verification And Set Up menu.
5. Run option 12 to set up the System i.
6. Determine the name and IP address of the mailhub.
7. Run option 14 to set up the mailhub specifying its name and IP.
8. Press F12 to return to the main menu.
9. Send a test to yourself using your "real" email address.
10. Check your email.

If after a reasonable time no email arrives, perform the following additional steps.

1. Add your "real" email address to your directory entry by running (this example uses "real" email address "billg@acme.com" and the directory entry "MYUSER MYSYSTEM"):

```
CHGDIRE USRID (MYUSER MYSYSTEM)
        MSFSRVLVL (*SYSMS) PREFADR (*SMTP)
        USRDFNFLD ((SMTPAUSRID SMTP 'billg')
                  (SMTPDMN SMTP 'acme.com'))
```

**Note:** If you are still signed on as QSECOFR, start a second session and sign on with your regular user profile to perform the send.

2. Display the Mail Verification And Set Up menu.
3. Run option 61 to restart/purge local mail on your System i.

**Note:** If your System i is currently being used to generate email from another application, make sure the Clear SMTP during restart (SMTPPURGE) and Clear MSF during restart (MSFPURGE) parameters specify \*NO to prevent email from being deleted.

4. Send a test to yourself taking by taking the default \*CURRENT.
5. Check your email.

If after a reasonable time no email arrives, move on to the detailed sections of this chapter. For additional information, see the *Trouble-Shooting* chapter of this manual.

---

## Quick Start Mail Set Up - Direct Delivery

If your installation does not include a mail server or if you do not have access to an ISP's mail server, you can configure your System i to directly deliver email to the world at large using the following steps. If any of the steps fail, move on to the detailed sections of this chapter.

1. Install SpoolMail on your System i (see the Installation chapter for details).
2. Display the main menu (GO SPOOLMAIL/SPOOLMAIL).
3. Run the option to verify that SpoolMail is installed correctly.
4. Display the Mail Verification And Set Up menu.
5. Run option 12 to set up the System i.
6. Configure IBM i access to DNS (see Manual Mail Set Up Steps).
7. Remove previously configured mailhub and mail router (see Manual Mail Set Up Steps).
8. Update the public DNS records for your domain (see Manual Mail Set Up Steps).
9. Press F12 to return to the main menu.
10. Send a test to yourself using your "real" email address.
11. Check your email.

If after a reasonable time no email arrives, perform the following additional steps.

1. Add your "real" email address to your directory entry by running (this example uses "real" email address "billg@acme.com" and the directory entry "MYUSER MYSYSTEM"):

```
CHGDIRE USRID (MYUSER MYSYSTEM)
        MSFSRVLVL (*SYSMS) PREFADR (*SMTP)
        USRDFNFLD ((SMTPAUSRID SMTP 'billg')
                  (SMTPDMN SMTP 'acme.com'))
```

**Note:** If you are still signed on as QSECOFR, start a second session and sign on with your regular user profile to perform the send.

2. Display the Mail Verification And Set Up menu.
3. Run option 61 to restart/purge local mail on your System i.

**Note:** If your System i is currently being used to generate email from another application, make sure the Clear SMTP during restart (SMTPPURGE) and Clear MSF during restart (MSFPURGE) parameters specify \*NO to prevent email from being deleted.

4. Send a test to yourself taking by taking the default \*CURRENT.
5. Check your email.

If after a reasonable time no email arrives, move on to the detailed sections of this chapter. For additional information, see the *Trouble-Shooting* chapter of this manual.

---

## Using The SMTP Set Up Command

The Verify Local SMTP (VFYLOCAL) command performs automatic verification and set up of SMTP on your System i. The command accepts a single parameter that determines if changes are made to IBM i. To verify the System i without making any changes select option 11 on the Mail Verification And Set Up menu or run the following command:

```
VFYLOCAL SETUP (*NO)
```

To make changes to your System i select option 12 on the Mail Verification And Set Up menu or run the following command:

```
VFYLOCAL SETUP (*YES)
```

In both cases SMTP verification is performed. Only if SETUP(\*YES) is specified does the command try to perform set up functions. You must be authorized to perform all of the verification and set up functions or the command fails. You can insure that you are authorized to perform all functions by signing on as QSECOFR.

**Note:** If you prefer to manually perform the functions of this program see the Appendix for a detailed description.

A log of activity is created during verification and set up. To view the log run DSPJOB, take option 4 and display the last spooled file.

If errors were encountered, detailed information can be found in your joblog. To view the information generated by VFYLOCAL, run the following command after the command has completed:

```
DSPJOBLOG
```

When the joblog is displayed, press F10 to display detailed messages and F18 to position to the end of the log.

The recommended procedure is to run verification first and review the results before running automatic set up.

---

## Using The Mailhub Set Up Command

The Verify Mailhub Server (VFYMAILHUB) command performs automatic verification and set up of a forwarding mailhub server for your System i. The command accepts three parameters that determine if changes are made to IBM i and the identity of the mailhub. To verify the mailhub without making any changes select option 13 on the Mail Verification And Set Up menu or run the following command (substitute the name and IP address of your forwarding mailhub server for "host\_name" and "ip"):

```
VFYMAILHUB RMTSYS(host_name) INTNETADR(ip) SETUP(*NO)
```

To make changes to your System i select option 14 on the Mail Verification And Set Up menu or run the following command (substitute the name and IP address of your external mailhub for "host\_name" and "ip"):

```
VFYMAILHUB RMTSYS(host_name) INTNETADR(ip) SETUP(*YES)
```

In both cases mailhub verification is performed. Only if SETUP(\*YES) is specified does the command try to perform set up functions. You must be authorized to perform all of the verification and set up functions or the command fails. You can insure that you are authorized to perform all functions by signing on as QSECOFR.



**Note:** If you prefer to manually perform the functions of this program see the Appendix for a detailed description.

A log of activity is created during verification and set up. To view the log run DSPJOB, take option 4 and display the last spooled file.

If errors were encountered, detailed information can be found in your joblog. To view the information generated by VFYMAILHUB, run the following command after the command has completed:

```
DSPJOBLOG
```

When the joblog is displayed, press F10 to display detailed messages and F18 to position to the end of the log.

The recommended procedure is to run verification first and review the results before running automatic set up.

---

## Manual Mail Set Up Steps

Depending on your System i, network configuration and your intended usage, there are several manual mail set up steps you may need to perform in order to use SMTP. These are described here.

### Installing TCP Connectivity Utilities

In order to send email from your System i, SMTP support must be installed. SMTP functions are delivered free of charge with IBM i as part of a separately installed licensed program product: 57xx-TC1 TCP/IP Connectivity Utilities. Detailed installation information and instructions can be found in *IBM i and related software > PDF file... > Installing, upgrading, or deleting IBM i and related software SC41-5120*.

### Changing Local Host and Domain Names

SMTP uses your System i's local host and domain name to identify itself to remote SMTP hosts to which it is sending mail. To configure the names:

- Run the Configure TCP/IP (CFGTCP) command.
- Select option 12 (Change TCP/IP domain information).
- Enter a host and domain name for your System i.

As an example, we use **ofc.gumbo.com** as the domain name and the **mailout** as the host name on our machine. If your domain is widget.com you might use:

```
Change TCP/IP Domain (CHGTCPDMN)

Type choices, press Enter.

Host name . . . . . 'mailout'

Domain name . . . . . 'ofc.widget.com'

Domain search list . . . . . *DFT

Host name search priority . . . *LOCAL *REMOTE, *LOCAL, *SAME
Domain name server:
  Internet address . . . . . '192.0.2.1'
                          '192.0.2.2'

Bottom
F3=Exit  F4=Prompt  F5=Refresh  F10=Additional parameters  F12=Cancel
F13=How to use this display  F24=More keys
```

## Creating a TCP Interface

A TCP interface establishes your System i identity (internet address) on a given line description. Typically, the line description for a local area network is used.

In order to add a TCP interface to a line description, you must determine the IP address and subnet mask to use. If you have a network administrator or other person responsible for assigning internet (IP) addresses, contact them. If you will connect your System i directly to the Internet, you must request that your internet service provider assign you an IP address or you must request that the Internet Corporation for Assigned Names and Numbers (ICANN) assign you a network number. If you will not connect your System i directly to the internet, and otherwise do not have an IP address for your system, you can use IP address "192.168.1.1" and Subnet Mask "255.255.255.0". This number is taken from the class B "192.168.0.0" network, which is reserved for internal networks as described in *RFC1597*. To add an interface after you have determined an IP address and subnet mask, run the following command:

```
ADDTCPIFC  INTNETADR(192.168.1.1) +
           LIND(line_description_name) +
           SUBNETMASK(255.255.255.0)
```

Substitute your values for the three parameters.

## Adding Host Name To Host Table



In order to deliver email correctly IBM i's SMTP host name must be associated with an IP address of one its TCP interfaces. This can be accomplished through DNS or you can add a local host table entry. To add a host table entry for IP address "192.168.1.1" with host name mailout, run the following command:

```
ADDTCPHTE  INTNETADR('192.168.1.1') +
           HOSTNAME(('mailout'))
```

Substitute your values for the two parameters. If the IP address already exists in the host table, use Change TCP/IP Host Table Entry (CHGTCPHTE) command to add the additional host name to the IP address.

## Configuring IBM i Access To DNS

When not using a mailhub, System i must access domain name system (DNS) servers to determine how to deliver email for a recipient. Typically, IP addresses for DNS servers are supplied by your internet service provider (ISP) or network administrator. If neither is available, a reasonable guess as to the IPs to use can be retrieved from a PC attached to the local area network that contains the System i:

-  Choose Start > Programs > Accessories > Command Prompt
-  Run command:

```
ipconfig /all 
```

-  Note the IP addresses given for DNS Servers.

```

Host Name . . . . . : PC001
Primary Dns Suffix . . . . . :
Node Type . . . . . : Unknown
IP Routing Enabled. . . . . : No
WINS Proxy Enabled. . . . . : No
DNS Suffix Search List. . . . . : ofc.widget.com

Ethernet adapter Widget Net:

    Connection-specific DNS Suffix . . : ofc.widget.com
    Description . . . . . : Broadcom 802.11b/g WLAN
    Physical Address. . . . . : 00-11-22-33-44-55
    Dhcp Enabled. . . . . : Yes
    Autoconfiguration Enabled . . . . : Yes
    IP Address. . . . . : 192.0.2.10
    Subnet Mask . . . . . : 255.255.255.192
    Default Gateway . . . . . : 192.0.2.1
    DHCP Server . . . . . : 192.0.2.132
    DNS Servers . . . . . : 192.0.2.1
                            192.0.2.2
    Lease Obtained. . . . . : Sunday, July 21, 2012 4:30:38 PM
    Lease Expires . . . . . : Monday, July 22, 2012 4:30:38 PM

C:\Documents and Settings\Programmer>

```

To configure System i to use DNS servers and confirm correct operation:

- From the IBM i command line, type CHGTCPDMN and press F4.
- Enter the DNS IP addresses in the Domain name server: Internet address (INTNETADR) parameter, press enter.

```

Change TCP/IP Domain (CHGTCPDMN)

Type choices, press Enter.

Host name . . . . . 'mailout'
Domain name . . . . . 'ofc.widget.com'

Domain search list . . . . . *DFT

Host name search priority . . . *LOCAL *REMOTE, *LOCAL, *SAME
Domain name server:
  Internet address . . . . . '192.0.2.1'
                          '192.0.2.2'

Bottom
F3=Exit  F4=Prompt  F5=Refresh  F10=Additional parameters  F12=Cancel
F13=How to use this display  F24=More keys

```

This example uses the fictitious DNS IP addresses 192.0.2.1 and 192.0.2.2

- Run the command:  
`ping ibm.com`
- If you do not get the message "Unknown host, ibm.com" DNS is working correctly.

**Note:** You may or may not get ping replies, but that is not important.

## Removing Previously Configured Mailhub and Mail Router

IBM i will deliver email directly if a mailhub and mail router are not configured. To check or remove the mailhub and mail router specifications, prompt the Change SMTP Attributes (CHGSMTPA) command, page down once and change the Mail router (MAILROUTER) parameter to \*NONE:

```
Change SMTP Attributes (CHGSMTPA)

Type choices, press Enter.

User ID delimiter . . . . . '.' *SAME, *DFT, 2, =, ., &, $...
Mail router . . . . . *NONE

Coded character set identifier 00819 1-65533, *SAME, *DFT
Outgoing EBCDIC/ASCII table:
  Outgoing EBCDIC/ASCII table . *CCSID Name, *SAME, *CCSID, *DFT
  Library . . . . . Name, *LIBL, *CURLIB
Incoming ASCII/EBCDIC table:
  Incoming ASCII/EBCDIC table . *CCSID Name, *SAME, *CCSID, *DFT
  Library . . . . . Name, *LIBL, *CURLIB
Firewall . . . . . *YES *SAME, *YES, *NO
Journal . . . . . *YES *SAME, *YES, *NO
Process all mail through MSF . *YES *SAME, *YES, *NO
Percent routing character . . . *YES *SAME, *YES, *NO

More...
F3=Exit F4=Prompt F5=Refresh F12=Cancel F13=How to use this display
F24=More keys
```

Page down three more times and change the Forwarding mailhub server (FWDHUBSVR) parameter to \*NONE:

```
Change SMTP Attributes (CHGSMTPA)

Type choices, press Enter.

Override reject connect list . . *NO *SAME, *NO, *YES
Allow bare line feed . . . . . *YES *SAME, *NO, *YES
Verify identification . . . . . *NO *SAME, *NO, *YES
Allow authentication . . . . . *NONE *SAME, *RELAY, *LCLRLY, *NONE
Verify MSF messages . . . . . *NO *SAME, *YES, *NO
Verify from user . . . . . *ALL *SAME, *ALL, *LIST, *NONE
Forwarding mailhub server . . . *NONE

Bottom
F3=Exit F4=Prompt F5=Refresh F12=Cancel F13=How to use this display
F24=More keys
```

## Updating Public DNS Records

When directly delivering email to the world at large, System i contacts each recipient's mail server and introduces itself using the fully qualified SMTP host name configured using the Change TCP/IP Domain (CHGTCPDMN) command. In the example below, the machine introduces itself as mailout.ofc.widget.com.

```

Change TCP/IP Domain (CHGTCPDMN)

Type choices, press Enter.

Host name . . . . . 'mailout'

Domain name . . . . . 'ofc.widget.com'

Domain search list . . . . . *DFT

Host name search priority . . . *LOCAL *REMOTE, *LOCAL, *SAME
Domain name server:
  Internet address . . . . . '192.0.2.1'
                          '192.0.2.2'

Bottom
F3=Exit   F4=Prompt   F5=Refresh   F10=Additional parameters   F12=Cancel
F13=How to use this display   F24=More keys

```

When a recipient's mail server is contacted by IBM i, the mail server sees the traffic as coming from the publicly visible IP address of your connection. For example, the external IP address of your DSL modem. To determine the IP address seen externally, go to <http://network-tools.com>. The IP address shown in the search box is the external public IP address of your connection.

Increasingly, mail servers are confirming the identity of machines sending email by performing a DNS look up on the fully qualified host name sent during the introduction, mailout.ofc.widget.com in this example. If the IP address returned by DNS is not the same as the visible IP address the traffic is coming from, email is rejected or discarded as spam.

To insure that your System i passes this test, you must add, or have your domain registrar add, an address record for your System i's fully qualified SMTP host name to the DNS records for your domain. In this example:

```
mailout.ofc.widget.com. IN A nnn.nnn.nnn.nnn
```

Is added to the DNS records for the domain widget.com where nnn.nnn.nnn.nnn is the publicly visible IP address determined above. This usually requires contacting your domain name registrar or the ISP hosting your domain, and is not an IBM i setting.

### Setting Up Local Users

A local user is someone who has a user profile (sign-on) on your System i. You should set up each local user who will be sending email to insure that the apparent "From:" address in the email will be correct and to insure that replies reach the sender. You do not need to set up local users who will not be sending mail. To configure hypothetical user JOE SALES (user profile JOES) as joe@acme.com, perform the following:

- If Joe already has a directory entry run:

```
CHGDIRE USRID(JOE SALES) MSFSRVLVL(*SYSMS)
      PREFADR(*SMTP)
      USRDFNFLD((SMTPAUSRID SMTP 'joe')
                (SMTPDMN SMTP 'acme.com'))
```

- If Joe does not have a directory entry run:

```
ADDDIRE USRID(JOE SALES) USRD('Sample entry')
      USER(JOES) SYSNAME(*LCL)
      MSFSRVLVL(*SYSMS) PREFADR(*SMTP)
```

```
USRDFNFLD((SMTPAUSRID SMTP 'joe')
           (SMTPDMMN SMTP 'acme.com'))
```

The user is now ready to send mail from your System i as joe@acme.com. For more details or information on setting up remote users, see the *Email Addresses* section of the *Implementation* chapter of this manual.

### Changing The System Start Program

You may wish to check your system's start up program to insure that the required subsystems are started automatically when your System i IPLs. The following steps are recommended:

- Insure that the SMTP server starts automatically when the Start TCP/IP (STRTCP) command is run:

```
CHGSMTPA AUTOSTART(*YES)
```

- Insure that your system start up program starts TCP/IP by including the command:

```
STRTCP
```

- Insure that your system start up program starts the IBM i Mail Server by including the command:

```
STRMSF
```

### Changing The Time Zone System Value

The time stamp placed in the email is based on the QTIMZON system value. Since most System i have the correct time, an incorrect time stamp usually indicates an incorrect time zone setting. For information on correctly setting the QTIMZON system value see the *System management > Time management* topic in the IBM i Information Center at <http://publib.boulder.ibm.com/series/>.

**Note:** QTIMZON also affects the timestamp applied to files in the Integrated File System (IFS).

### Changing The SMTP Port Number

Some installations use an SMTP port number other than the well-known port 25. You can control the port number used by IBM i's SMTP stack by running the Configure TCP/IP (CFGTCP) command, selecting option 21. Configure related tables, then selecting option 1. Work with service table entries.

---

## Additional Mail Set Up Resources

The information in this chapter was drawn and condensed from the IBM i Information Center. You can find additional detail and more comprehensive coverage of IBM i configuration by going to the *Networking > TCP/IP applications, protocols, and services > E-mail* topic in the IBM i Information Center at <http://publib.boulder.ibm.com/series/>.

For Domino on System i users, our software uses IBM i's SMTP services to deliver mail. Valuable information on setting up Domino's and IBM i's SMTP stack to coexist on the same System i can be found in the IBM Redbook *V5 TCP/IP Applications on the IBM eServer iSeries Server SG24-6321* available at <http://publib.boulder.ibm.com/series/>.

---

## Quick Start - Create A Logical Printer

Once you are successfully sending email you can automate the process by creating a logical printer.

1. Run option 12 and specify a printer name and port (use 1 if you are not sure).
2. Edit the SNDSPMAIL command when prompted with SEU. Specify the recipient.
3. Move a spooled file to the output queue and release it.

---

## Chapter 5 Implementation

---

### What's In This Chapter

This chapter describes how to implement SpoolMail in your environment. The chapter:

- Gives an overview of implementation choices.
- Describes changing programs to send email.
- Describes manually sending email.
- Describes creating a Gumbo logical printer.
- Describes sharing a Gumbo logical printer on the network.
- Describes authority adoption by Gumbo logical printers.
- Describes integration with Report Manager.
- Describes email address details.
- Describes adding line breaks to the message.
- Describes digitally signing the message.
- Describes adding user defined data to a spooled file.
- Describes useful spooled file information.
- Describes adding bookmarks to PDF files.
- Describes digitally signing PDF files.
- Describes a CL coding tip.
- Describes changing command defaults.

---

### Overview

The first step in implementing SpoolMail is to set up IBM i's mail functions if this has not already been done. Refer to the Set Up chapter in this manual for detailed instructions. After set up you are ready to begin implementation.

The main function of SpoolMail is accessed by running the Send Spool Mail (SNDSPLMAIL) command. The command takes a spooled file and an email address as input, converts the spooled file and sends it to the recipient. To implement SpoolMail in your environment you have four basic choices:

1. Modify each program that creates spooled files that will be emailed to directly run the Send Spool Mail (SNDSPLMAIL) command.

<b>Pros</b>	The spooled file is always sent as soon as it is created.
<b>Cons</b>	Programs must be modified and recompiled.

2. Manually run the Send Spool Mail (SNDSPLMAIL) command from a command line or using option 14 from the Work with Gumbo Spooled Files (WRKGSISPLF) or Work with Gumbo Output Queue (WRKGSIOUQ) displays.

<b>Pros</b>	Good for casual or on demand use, no program changes required.
<b>Cons</b>	Requires manual operations and scheduling.

3. Create a Gumbo logical printer device to run the Send Spool Mail (SNDSPLMAIL) command for each spooled file placed in the printer's output queue.

<b>Pros</b>	No program changes, no manual intervention.
<b>Cons</b>	Fixed email address, limited flexibility compared to Report Manager.

4. Automatically run the Send Spool Mail (SNDSPLMAIL) command using **GUMBO's** Report Manager.

<b>Pros</b>	No program changes, no manual intervention, extensive distribution and bursting options.
<b>Cons</b>	Additional product required.

In all cases, using IBM i distribution lists can simplify the sending of email. See the section on Using Distribution Lists later in this chapter. Also, see the following sections for a detailed discussion of the choices.

---

## Changing Programs

SpoolMail can be implemented by changing the programs that create spooled files to send them directly. A typical batch Control Language (CL) program that creates a spooled file would contain the following CL sequence:

```

      .
      .
OVRDBF  FILE(INVENTORY) TOFILE(INVLIB/INVENTORY)
OVRDBF  FILE(CUSTOMER) TOFILE(INVLIB/CUSTOMER)
CALL    PGM(INVLIB/INV320)
      .
      .

```

If program INV320 generates spooled file QSYSPRT then the following changes will send the spooled file to the distribution list INV320 REPORT:

```

      .
      .
OVRPRTF FILE(QSYSPRT) HOLD(*YES) /* Can't let it print */
OVRDBF  FILE(INVENTORY) TOFILE(INVLIB/INVENTORY)
OVRDBF  FILE(CUSTOMER) TOFILE(INVLIB/CUSTOMER)
CALL    PGM(INVLIB/INV320)
SNDSPLMAIL FILE(QSYSPRT) TOUSRID(INV320 REPORT)
RLSSPLF FILE(QSYSPRT) SPLNBR(*LAST) /* Now it can print */
      .
      .

```

The spool file is emailed as soon as program INV320 has completed processing.

We recommend using a distribution list with the same name as the program. This moves the distribution details outside of the program and the list of recipients can be updated without changing the program again.

---

## Manually Sending Email

SpoolMail can be implemented by assigning an operator the task of manually sending spooled files. SpoolMail's Work with Gumbo Spooled Files (WRKGSISPLF) or Work with Gumbo Output Queue (WRKGSIOUQ) commands provide a convenient means of accomplishing this. Suppose the operator should send all spooled files created by user QPGMR and program INV320 in the NIGHTBATCH output queue to the distribution list INV320 REPORT. The following command displays a list of spooled files created by user QPGMR:

```
WRKGSISPLF SELECT(QPGMR)
```

The operator enters option 14 for each spooled file to send and enters the recipient on the parameter line as illustrated:



```

Work with Gumbo Spooled Files

Type options, press Enter.
  1=Send  2=Change  3=Hold  4=Delete  5=Display  6=Release  7=Message
  8=Attributes  9=Print Status  12=Convert  14=Email  15=Merge

Opt  File      User      Device or  User      Total  Cur
     File      User      Queue     Data     Sts    Pages Page
14   QSYSPRT   QPGMR    NIGHTBATCH  INV320   RDY    1
14   QSYSPRT   QPGMR    NIGHTBATCH  INV320   RDY    1
   ___ QPJOBLOG   QPGMR    QEZJOBLOG   TEST     RDY    2
   ___ QPJOBLOG   QPGMR    QEZJOBLOG   PRT02    RDY    1
14   QSYSPRT   QPGMR    NIGHTBATCH  INV320   RDY    1
14   QSYSPRT   QPGMR    NIGHTBATCH  INV320   RDY    1

                                                                 Bottom

Parameters for options or command
===>  TOSMTPNAME (billg@acme.com)
F3=Exit  F4=Prompt  F5=Refresh  F9=Retrieve  F11=Change view  F12=Cancel
F17=Top  F18=Bottom  F22=Printers
© Copyright Gumbo Software, Inc. 1997, 2012. All Rights Reserved.

```

By pressing enter, the spooled files are sent to billg@acme.com. The spooled files remain on the system.

---

## Creating A Gumbo Logical Printer

SpoolMail can be implemented by using the Create Device Gumbo Printer (CRTDEVGLP) command to create a Gumbo logical printer.

A Gumbo logical printer is a printer device that performs spooled file processing instead of printing on paper. As with other printer devices, you use IBM i's writer commands (WRKWTR, STRPRTWTR, ENDWTR, HLDWTR, etc.) and IBM i's configuration commands (WRKCFGSTS, VFYCFG, etc.) to control a Gumbo logical printer's operation.







When you create a Gumbo logical printer using the Create Device Gumbo Printer (CRTDEVGLP) command, a source file with the same name is create in library QUSRSYS. The source file contains a member with the same name as the printer and in the source member is a single Control Language (CL) command. As a Gumbo logical printer processes, it runs this command once for each spooled file in the output queue.

After creating the Gumbo logical printer, move your spooled files to the printer's output queue and release them to initiate processing.

---

## Sharing A Gumbo Logical Printer





A Gumbo logical printer is a printer device that performs SpoolMail's spooled file processing instead of printing on paper. You can create a share for the Gumbo logical printer that allows PC user to "print" to it and receive its services. To create a print share for Gumbo logical printer GLP01, follow these steps:

1.  Open a connection to your System i using System i Navigator.
2.  Expand Network.
3.  Expand Servers.
4.  Click TCP/IP to retrieve a list of TCP/IP servers available.
5.  Right-click IBM i NetServer and select Open.
6.  Right-click Shared Objects and select New and then Printer.
7.  Use the General Properties page and configure:
  - Share name: GLP01
  - Description: SpoolMail Printer
  - Output queue: GLP01
  - Output queue library: QUSRSYS



- Printer driver: (leave blank)
  - Spooled file type: Advanced function printing
8.  Click OK.

**Note:** The System i Navigator online help provides more details about NetServer file share properties.

Once a share has been created, map to it from your Windows PC by following these steps:

1.  From the Windows Control Panel, double click Printers.
2.  Double click Add Printer.
3.  Click next.
4.  Select Network printer and click next.
5.  Select Type printer name, enter \\server-name\GLP01 and click next.





**Note:** server-name is the name by which your System i is known to the Windows Network Neighborhood.

6.  When the Connect to Printer pop-up appears click OK.
7.  When the Add Printer Wizard pop-up appears, double click Manufactures: IBM.
8.  Double click IBM AFP 300. Click next.

**Note:** If you do not have the AFP print drivers they can be loaded using System i Access Set Up.

9.  Click Finish.

We suggest you change the printer's settings to print text as text instead of graphics. To do so:

1.  Right click the newly created "GLP01 on server-name" and select properties.
2.  Click the Advanced tab.
3.  Click Printer Defaults.
4.  Set Print Text as Graphics to Off, click OK.
5.  Click OK.

---

## Gumbo Logical Printer Authority Adoption

SpoolMail programs SMC\_40001 and SMC\_40002 adopt owner authority as a convenience for our customers. The programs are the "print device driver programs" called by IBM i when a print writer is driving a "Gumbo Logical Printer". i.e. if you are not using Gumbo logical printers you can safely remove authority adopt.

During start up the programs determine the environment by inspecting the device description, retrieving source code from the associated source file and adding the product's library to the job's library list. In operation, the programs are responsible for receiving IBM i's call to process a spooled file, marshaling the passed data, running the device's command, and responding to IBM i.

The actions performed are described in IBM's documentation for API QSPSETWI and print device driver exit program.

IBM i starts all print writers under the QSPLJOB user profile. You can remove the adopt by granting QSPLJOB authorities to perform the required actions. You can determine what these are by removing the adopt, starting the writer and finding the authority failures in the job log. Grant the needed authority, end and restart the writer, and repeat until no more failures occur.

---

## Integration With Report Manager

**GUMBO's** Report Manager is a software utility that automates report distribution and spooled file management on the IBM System i. SpoolMail can be integrated with Report Manager or similar products that monitor an output queue and process spooled files upon arrival. Suppose Report Manager is installed and a definition for report

INV320 has been created. To have Report Manager automatically email spooled files created by INV320 to the distribution list INV320 REPORT, run the Add Report Subscription command:

```
ADDRPTSUB  RPT (INV320)  USER (*USRID)  USRID (INV320  REPORT)
            OUTQ (*NONE)  SNDFMT (*EMAIL)
```

Each time an INV320 spooled file is processed, it is emailed to INV320 REPORT in addition to the deliveries for other subscribers.

---

## Email Addresses

There are three choices for addressing mail created by SpoolMail, direct SMTP addressing, special values, and directory entries stored in the system distribution directory. With direct SMTP addressing, you enter the email address directly on the parameter, no additional address set up is required. SpoolMail supports the full range of email address formats, including route specification and *RFC3490 Internationalizing Domain Names in Applications (IDNA)*. Valid formats for email addresses include:

- 'mali@acme.com'
- '<mali@acme.com>'
- 'Mohammed Ali <mali@acme.com>'
- '"Mohammed Ali" <mali@acme.com>'
- 'Mohammed Ali (I am the Greatest) <mali@acme.com>'

In all of these examples the message is delivered to the mailbox mali@acme.com.

### Address Resolution For Special Values

SpoolMail supplies several special values for specifying email addresses. For example, \*CURRENT is the default value on the From (originator) Address parameter.

SpoolMail uses the following steps to resolve an email address for special values that imply an IBM i user profile.

- If the user profile implied by the special value is enrolled in the system distribution directory and the entry contains an email address the email address is used.
- If the user profile implied by the special value is enrolled in the system distribution directory and the entry does not contain an email address an IBM i style address is generated in the form: usrid?address@host.domain.
- If the user profile implied by the special value is not enrolled in the system distribution directory an email address is generated in the form: userprofile@host.domain

**Note:** In the above, host and domain are taken from the values entered on the CFGTCP option 12 panel.

Therefore, to have the correct email address resolved, you should add or update a system distribution directory entry for each user profile that will be referenced by the special values you will use. Usually this is every user profile that will send email.

### Setting Up Directory Entry Email Addresses For Local Users

IBM i's system distribution directory can contain addressing information for users. Directory entries can be created for users who are local to the System i (have an IBM i user profile) and for users who are remote (do not have an IBM i user profile). Local users can receive their mail on the System i using IBM i's POP server or from a remote mail application such as Exchange. You should set up each local user who will be sending email to insure that the apparent "From:" address in the email will be correct and to insure that replies reach the sender. To add a directory entry for user profile **MYUSER**, run the following command: (for this example, assume the user's email address is billg@acme.com):

```
ADD DIRE  USRID (MYUSER  MYSYSTEM)  USRD ('Sample entry')
            USER (MYUSER)  SYSNAME (*LCL)
            MSFSRVLVL (*SYSMS)  PREFADR (*SMTP)
```

```
USRDFNFLD((SMTPAUSRID SMTP 'billg')
           (SMTPDMN SMTP 'acme.com'))
```

**Note:** If you are running Lotus Domino for IBM i, run:

```
ADDDIRE USRID(MYUSER MYSYSTEM) USRD('Sample entry')
        USER(MYUSER) SYSNAME(*LCL)
        MSFSRVLVL(*DOMINO) PREFADR(*SMTP)
        USRDFNFLD((SMTPAUSRID SMTP 'billg')
                  (SMTPDMN SMTP 'acme.com'))
```

To update an existing directory entry for user profile **MYUSER**, run the following command:

```
CHGDIRE USRID(MYUSER MYSYSTEM)
        MSFSRVLVL(*SYSMS) PREFADR(*SMTP)
        USRDFNFLD((SMTPAUSRID SMTP 'billg')
                  (SMTPDMN SMTP 'acme.com'))
```

### Setting Up Directory Entry Email Addresses For Remote Users

You do not need to set up remote user in order to send them email, but it will enable you to use distribution lists. To add a directory entry for a remote user who will receive email mail from the System i, run the following command (for this example, assume the user's email address is johnp@acme.com):

```
ADDDIRE USRID(RMT1 EMAIL) USRD('Sample entry 2')
        USER(*NONE) SYSNAME(TCPIP)
        MSFSRVLVL(*SYSMS) PREFADR(*SMTP)
        USRDFNFLD((SMTPAUSRID SMTP 'johnp')
                  (SMTPDMN SMTP 'acme.com'))
```

**Note:** The choice of USRID(RMT1 EMAIL) is arbitrary, select names that are convenient. The system name must be **TCPIP**.

To add a directory entry for a Domino user who does not have an IBM i user profile, run the following command (for this example, assume the user's email address is suej@acme.com):

```
ADDDIRE USRID(DOMINO EMAIL) USRD('Sample entry 3')
        USER(*NONE) SYSNAME(TCPIP)
        MSFSRVLVL(*DOMINO) PREFADR(*SMTP)
        USRDFNFLD((SMTPAUSRID SMTP 'suej')
                  (SMTPDMN SMTP 'acme.com'))
```

**Note:** The choice of USRID(DOMINO EMAIL) is arbitrary, select names that are convenient. The system name must be **TCPIP**.

### Using Distribution Lists

Once you have directory entries set up you can also set up distribution lists. These are lists of recipients (both local and remote) that can be maintained independently of the programs that use the lists. By sending to a distribution list, you send to each entry on the list.

Like directory entries, distribution list IDs have two parts. To make it convenient to manage the system, set up a naming convention for list IDs; for example, INV320 REPORT and INV330 REPORT could be list IDs for recipients of the INV320 and INV330 reports respectively. Such a convention allows lists to be easily associated with their use.

Suppose that the INV320 report should be sent to billg@acme.com and to johnp@acme.com. To create a distribution list to reflect this, run the following commands:

1. Create the distribution list:

```
CRTDSTL LSTID(INV320 REPORT)
        LSTD('INV320 report distribution')
```

2. Add 2 entries to the distribution list:

```

ADDSTLE LSTID(INV320 REPORT)
        USRID((MYUSER MYSYSTEM) (RMT1 EMAIL))

```

You are now ready to send to the two users with one command by specifying the **To (distribution list)** parameter:

```
(other command parameters) ... TOUSRID(INV320 REPORT)
```

## Adding Line Breaks to the Message

### When Using \*TEXTPLAIN

The following CL program fragment shows how to create a message variable that contains a line break (carriage return/line feed pair):

```

...
DCL VAR(&MSG) TYPE(*CHAR) LEN(2048)
DCL VAR(&CRLF) TYPE(*CHAR) LEN(2) VALUE(X'0D25')
DCL VAR(&LIN1) TYPE(*CHAR) LEN(72) VALUE('First line.')
DCL VAR(&LIN2) TYPE(*CHAR) LEN(72) VALUE('Second line.')
...
CHGVAR VAR(&MSG) VALUE(&LIN1 |< &CRLF || &LIN2)
...

```

The resulting message is:

```

First line.
Second line.

```

The equivalent RPG is:

```

C      ...      move      x'0d25'      crlf      2
C      ...      movel     'First line.' lin1      72
C      ...      movel     'Second line.'lin2      72
C      ...      eval      msg = %trimr(lin1) + crlf + lin2
...

```

### When Using \*TEXTHTML

The following CL program fragment shows how to create a message variable that contains a line break.

```

...
DCL VAR(&MSG) TYPE(*CHAR) LEN(2048)
DCL VAR(&BR) TYPE(*CHAR) LEN(2) VALUE('<br>')
DCL VAR(&LIN1) TYPE(*CHAR) LEN(72) VALUE('First line.')
DCL VAR(&LIN2) TYPE(*CHAR) LEN(72) VALUE('Second line.')
...
CHGVAR VAR(&MSG) VALUE(&LIN1 |< &BR || &LIN2)
...

```

The resulting message is:

```

First line.
Second line.

```

The equivalent RPG is:

```

C      ...      move      '<br>'      br      4
C      ...      movel     'First line.' lin1      72
C      ...      movel     'Second line.'lin2      72
C      ...      eval      msg = %trimr(lin1) + br + lin2
...

```

---

## Digitally Signing The Message

Email produced by SpoolMail can optionally be digitally signed using S/MIME Signed Message format. S/MIME (Secure / Multipurpose Internet Mail Extensions) is a standard for public key encryption and signing of email encapsulated in MIME. A signed message is an ordinary message with a digital signature added by the sender. The signature has two purposes: it identifies the sender, and it verifies that the content of the message has not been altered since the message was sent.

You create digitally signed email by specifying an **Application ID** when the email is created. There are two ways to accomplish this: at the command level and at the system (or LPAR) level. The command level overrules the system level. For command level, specify an **Application ID** directly on the send command's new **Signing key** (SGNKEY) parameter. For the system level, specify an **Application ID** on the CHGSMIDFT command's new **Signing key** (SGNKEY) parameter.

The shipped default values for the **Signing key** (SGNKEY) parameters are \*DEFAULT and \*NONE respectively.

**Application ID** refers to the name you have given to a digital certificate when placing it in the \*OBJECTSIGNING Certificate Store using IBM i's Digital Certificate Manager (DCM). DCM is option 34 of IBM i. You can determine if DCM has been installed by running the Display Software Resources (DSPSFWRSC) command.

Complete information on setting up DCM, creating and storing certificates and adding **Application IDs**, can be found in the *Security > Digital Certificate Manager* topic in the IBM i Information Center at <http://publib.boulder.ibm.com/series/>.

---

## Adding User Defined Data

The Send Spool Mail (SNDSPLMAIL) command can retrieve the To (recipient) (TOSMTPNAME) parameter which is the recipient's email address and/or the From (originator) (FROM) parameter from data stored in a spooled file's user defined data parameter. The following CL code fragment shows how to store the recipients email address 'joe@widget.com' and the sending user profile INFO in a spooled file's user defined data field and reference it on the Send Spool Mail (SNDSPLMAIL) command:

```
      .  
      .  
OVRPRTF  FILE(QSYSVRT) HOLD(*YES) /* Can't let it print */ +  
          USRDFNDTA('MAILTAG(joe@widget.com) MAILSENDER(INFO)')  
CALL     PGM(INVLIB/INV320)  
SNDSPLMAIL FILE(QSYSVRT) TOSMTPNAME(*MAILTAG) +  
          FROM(*MAILSENDER)  
RLSSPLF  FILE(QSYSVRT) SPLNBR(*LAST) /* Now it can print */  
DLTOVR   FILE(QSYSVRT)  
      .  
      .
```

---

## Useful Spooled File Information

IBM i provides powerful printing capabilities collectively known as AFP (Advanced Function Presentation). If you use IPDS printers you also need PSF/400. Otherwise, the base operating system gives you everything you need to take advantage of the power of AFP. For example, you can create overlays (electronic forms) to replace preprinted forms and print invoices on plain paper on your laser printers. Detailed information on AFP can be found in the *Printing > Advanced Function Presentation (AFP)* topic of the IBM i Information Center at <http://publib.boulder.ibm.com/series/>.

The single best source that we've found for information on all aspects of IBM i printing is the Redbook *Printing V SG24-4389* (and its replacement *Printing VI SG24-6250*). The books are available for download in the PDF format at <http://www.redbooks.ibm.com>.

The Redbook supplements the standard reference documents on printing by providing more specific "how to" information, such as diagrams, programming samples, and working examples. We find that it pulls together the information from other manuals and fits the pieces together in an understandable way.

## Creating Overlays and Page Segments

InfoPrint's (formerly IBM's®) AFP Printer Driver is a very useful piece of software that allows you to create IBM i overlays and page segments by "printing" from any PC based application. Best of all, it is free and available for download at [www.infoprintsolutionscompany.com](http://www.infoprintsolutionscompany.com), search on "AFP Printer Driver" or Google "'AFP Printer Driver for Windows" download site:ibm.com'. In addition, Google *AFP AS/400 Programming Sampler* which contains useful tools for compiling the overlays and page segments on your System i. The sampler.savf was last spotted at <ftp://ftp.software.ibm.com/printers/products/as400>

Additional information is available from the IBM Software Knowledge Base Document Number 5184341, *Creating AFP Resources Using the IBM AFP Printer Drivers*.

Our experience shows that you get the best results using a smaller is better approach to creating overlays and page segments. Trim as much as possible and position instead of creating a page size overlay or page segment. Use the lowest resolution, color depth, etc. that gives acceptable results.

### \*LINE and \*AFPDSLINE Data

Our spooled file conversions do not process spooled files with printer device type \*LINE or \*AFPDSLINE. However IBM i allows you to convert these to pure \*AFPDS data which can be processed (most conversions). There are two methods for accomplishing this:

1. The printer file's CVTLINDTA() parameter while creating the spooled file.
2. Respooling an existing \*LINE or \*AFPDSLINE spooled file using CRTAFPDTA/PRTAFPDTA commands.

See Redbook *Printing VI SG24-6250* for details and examples.

---

## Adding Bookmarks To PDF Files

When converting spooled files to PDF with SpoolMail you can specify that bookmarks are to be included in the generated PC file. Bookmarks provide easy navigation to specific portions of the report. When a bookmark is clicked, Adobe's Acrobat viewer positions the file directly to the page the bookmark references.

The inclusion of bookmarks is controlled by the "PDF bookmark style" PDFBKMSTY() and "PDF bookmark data source" PDFBKMSRC() command parameters which specify what data to use for bookmarking and how the bookmarks are presented.

Consider the following sample pages from a spooled file:

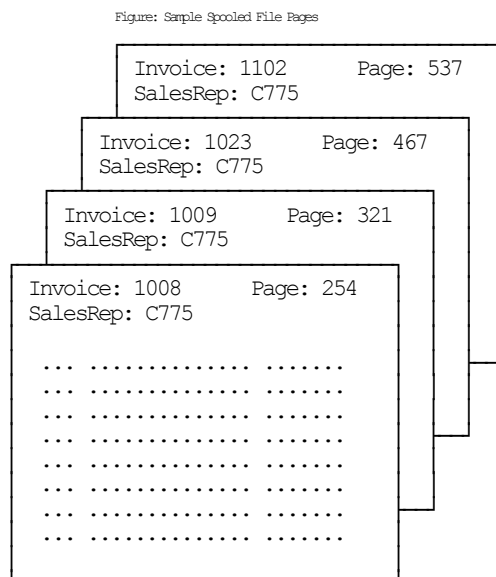

**Note:** All but 4 pages were omitted for brevity.

Specifying line=2, position=12, length=4 as name 'Rep No.' and line=1, position=11, length=4 as 'Invoice' with one level of bookmarking:

```
PDFBKMSSTY(*ONELEVEL)
PDFBKMSRC((2 12 4 'Rep No.') (1 11 4 'Invoice'))
```

Generates the following bookmarks in the PDF:

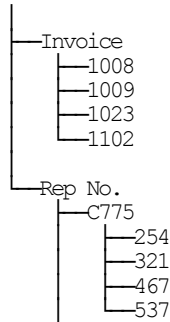

Using \*TWOLEVEL instead of \*ONELEVEL generates (the invoice top level bookmark has been omitted from the diagram for brevity):

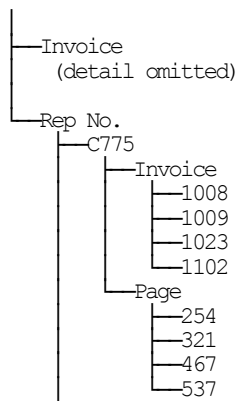

For more details on specifying data sources see the PDFBKMSRC() command parameter description.

### Adding DOCIDXTAG DDS Printer File Keywords

One of the possible sources of bookmarking data for \*AFPDS spooled files is DDS's DOCIDXTAG keyword. When present in the spooled file they can be selected by the "PDF bookmark data source" PDFBKMSRC() command parameter's special values \*DOCIDXTAG, \*DOCIDXTAGP and \*DOCIDXTAGG.

The DOCIDXTAG() DDS keyword allows you to specify one or more "attribute-name"/"attribute-value" pairs for a page or group of pages. Examples pairs would be "POLICY NUMBER"/"12345" or "CUSTOMER NUMBER"/"67890". SpoolMail uses the pairs to construct bookmarks as specified by the "PDF bookmark style" PDFBKMSSTY() command parameter.

You add DOCIDXTAG data to your spooled file by specifying the DOCIDXTAG keyword in the printer file that creates the spooled file:



```

      ...
A      R RECORD1
A 02
A      DOCIDXTAG('Policy Number' +
                '43127' PAGE)
— or —
      ...
A      R RECORD2
A
A      DOCIDXTAG(&NAM &VAL PAGE)
A      NAM      20A P
A      VAL      10A P
      ...

```

For complete details see the *Programming > DDS > DDS for printer files* topic in the IBM i Information Center at <http://publib.boulder.ibm.com/series/>.

### Adding STRPAGGRP DDS Printer File Keywords

One of the possible sources of bookmarking data for \*AFPDS spooled files is DDS's STRPAGGRP keyword. When present in the spooled file they can be selected by the "PDF bookmark data source" PDFBKMSRC() command parameter's special value \*STRPAGGRP.

The STRPAGGRP() DDS keyword in conjunction with the ENDPAGGRP DDS keyword allows you to define a group of pages and assign them a name. Examples names would be "POLICY NUMBER 12345" or "CUSTOMER NUMBER 67890". SpoolMail uses the grouping and its name to construct bookmarks as specified by the "PDF bookmark style" PDFBKMSTY() command parameter.

You add page group information to your spooled file by specifying the STRPAGGRP/ENDPAGGRP keywords in the printer file that creates the spooled file:

```

      ...
A      R RECORD1
A 02
A      STRPAGGRP('Policy Number +
                43127')
— or —
      ...
A      R RECORD2
A
A      STRPAGGRP (&NAM)
A      NAM      20A P
A      VAL      10A P
      ...

```

For complete details see the *Programming > DDS > DDS for printer files* topic in the IBM i Information Center at <http://publib.boulder.ibm.com/series/>.

---

## Digitally Signed PDF Files

PDF files produced by SpoolMail can be, optionally, digitally signed. The signature included in the PDF document allows the identity of the author to be validated and provides additional assurance that the PDF document has not been tampered with after it was signed.

You create digitally signed PDF documents by specifying an **Application ID** when the document is created. There are two ways to accomplish this: at the command level and at the system (or LPAR) level. The command level overrides the system level. For command level, specify an **Application ID** directly on the command's **PDF document signing key** (PDFSGNKEY) parameter. For the system level, specify an **Application ID** on the CHGSM1DFT command's **PDF document signing key** (PDFSGNKEY) parameter.

The shipped default values for the **PDF document signing key** (PDFSGNKEY) parameters are \*DEFAULT and \*NONE respectively.

**Application ID** refers to the name you have given to a digital certificate when placing it in the \*OBJECTSIGNING Certificate Store using IBM i's Digital Certificate Manager (DCM). DCM is option 34 of IBM i. You can determine if DCM has been installed by running the Display Software Resources (DSPSWRSC) command.

For complete information on setting up DCM, creating and storing certificates and adding **Application IDs**, see the *Security > Digital Certificate Manager* topic in the IBM i Information Center at <http://publib.boulder.ibm.com/series/>.

---

## CL Coding Tip

Many of our commands accept a variable number of values for a given parameter. For example, the Send Spool Mail (SNDSPLMAIL) command accepts up to 300 email addresses on the recipient parameter. When writing CL programs, the problem of how to code for a variable number of email addresses without coding the SNDSPLMAIL command multiple times (once for each address count) arises. The solution is a little known CL trick for coding "no value" in a variable. "No value" is represented in CL by '\*N'. Consider the following program fragment:

```
PGM
DCL      VAR (&ADD1) TYPE (*CHAR) LEN (128) VALUE ('*N')
DCL      VAR (&ADD2) TYPE (*CHAR) LEN (128) VALUE ('*N')
DCL      VAR (&ADD3) TYPE (*CHAR) LEN (128) VALUE ('*N')

CHGVAR   VAR (&ADD1) VALUE (NOBODY@GUMBO.COM)

SNDSPLMAIL FILE (QPDSPLIB) TRANSFORM(*TXT) +
          TOSMTPNAME ((&ADD1) (&ADD2) (&ADD3))

ENDPGM
```

Since &ADD2 and &ADD3 contain '\*N' they are treated as if they were not specified on the command and the email is sent to only one address.

---

## Changing Command Defaults

As with any CL command, you can change the default values of the commands found in our products. You do this using the IBM i Change Command Default (CHGCMDDDFT) command.

But before you do, there are some gotchas (slang term for "I got you": a trap) you should be aware of. You WILL lose the change each time a new release of the product is installed, and you COULD lose the change when PTFs are applied to the product. You must then reapply the default change.

As an example, to change the default transform on SpoolMail's SNDSPLMAIL command from \*TXT to \*PDF4, run the following:

```
CHGCMDDDFT  CMD (SNDSPLMAIL) NEWDFT (' TRANSFORM (*PDF4)')
```

**GUMBO** recommends AGAINST changing command defaults, we know from the calls for support we receive that this regularly causes problems for customers.

---

## Chapter 6 Conversions

---

### What's In This Chapter

This chapter describes the spooled file conversions available with SpoolMail. The chapter:

- Gives an overview of the conversions process.
- Describes the ASCII text conversion.
- Describes the Portable Document Format conversion.
- Describes the Rich Text Format conversion.
- Describes the Hyper Text Markup Language conversion.
- Describes the Tag Image File Format conversion.
- Describes the Host Print Transform conversion.
- Describes the no conversion conversion.
- Describes the PostScript conversion.
- Describes the Final Form Text conversion.
- Describes the AFP print file conversion.

---

### Overview

The Send Spool Mail (SNDSPLMAIL) command retrieves the requested spooled file from IBM i's spool store and converts it for email delivery. IBM i applications can produce spooled files in the following data streams:

- \*SCS (SNA Character String)
- \*IPDS (Intelligent Printer Data Stream)
- \*AFPDS (Advanced Function Presentation Data Stream)
- \*USERASCII (ASCII data stream)
- \*LINE (1403 line data)
- \*AFPDSLINE (Mixed \*AFPDS and \*LINE data)

The type of data stream produced is determined by the DEVTYPE parameter of the printer file associated with the application.

The Send Spool Mail (SNDSPLMAIL) command converts the spooled file in one of two ways based on the SEND parameter. With SEND(\*ATTACH), which is the default, the spooled file's contents are converted into a PC file that is sent as an attachment to an email message. With SEND(\*TEXTPLAIN) the spooled files contents are copied directly into the body of an email message.

SpoolMail can produce attached PC files in several different formats:

- Carriage return/line feed delimited ASCII text (TXT)
- Adobe's Portable Document Format (PDF)
- Microsoft's Rich Text Format word processor file (RTF)
- Hyper Text Markup Language (HTML)
- Tag Image File Format (TIFF)
- Printer specific print data streams produced by IBM i's Host Print Transform (HPT)
- An unaltered copy of the original print data stream (NONE)
- Adobe's PostScript (PS)
- IBM's Final Form Text (FFT)
- IBM's AFP print file (APF)

Not all of the possible conversions are applicable to all spooled file print data streams. The following table shows the supported conversions:

Figure: Print Data Stream/Conversion Matrix

Input Spooled File Print Data Stream	Output Data Format Conversion								
	PDF	TXT	RTF	HTML	HPT	NONE	PS	FFT	TIFF
*SCS	YES	YES	YES	YES	YES	YES		YES	YES
*IPDS	YES	YES	YES	YES		YES		YES	
*AFPDS	YES	YES			YES	YES	YES		YES
*USERASCII						YES			
*LINE	note	note			note	YES	note		note
*AFPDSL	note	note			note	YES	note		note

Notes:

- o Print Data Stream is found on WRKSPLFA's "Printer device type" parameter. Use option 8 from WRKOUTQ or WRKSPLF.
- o PDF is double byte enabled for Chinese/Japanese/Korean.
- o TXT is double byte enabled for \*SCS.
- o Convert \*LINE and \*AFPDSL to \*AFPDS using OVRPRTF CVTLINDTA(\*YES) or respool using CRTAFPDTA/PRTAFPDTA.

The conversion process is governed by the Send Spool Mail (SNDSPLMAIL) command's TRANSFORM() parameter. Depending on the transform specified, the Target coded character set id (CCSID), Source coded character set id (SRCCSID) and Workstation customizing object (WSCST) parameters also play a role.

The following sections describe the conversions in more detail.

## ASCII Text

ASCII text PC file format is the simplest of the conversion processes. Each line of the input spooled file is converted from EBCDIC to ASCII based on the source and target CCSIDs specified. A carriage return and line feed are appended to the end of the line. Additional carriage return line feed pairs are inserted to account for blank lines in the page. For transform \*TXT, pages are filled from the last print line to bottom of the page with additional blank lines. For transform \*TXTFF a single <FORM FEED> control is placed at the end of the last printed line on each page. For transform \*TXTTRIM the line padding is omitted on the last page.

The generated file can be read by any ASCII capable viewer. Virtually every machine has an ASCII capable viewer making this transform useful when the capabilities of the recipient's machine are unknown or limited.

You specify this conversion by specifying TRANSFORM(\*TXT), TRANSFORM(\*TXTFF) or TRANSFORM(\*TXTTRIM).

This conversion is Double Byte Character Set (DBCS) enabled for \*SCS.

There is a limitation when converting an AFPDS spooled file to text. If the lines of a spooled file are printed out of sequential order, the results will not be as expected. The text processor does not have the ability to "move backward" in the generated data and insert new data into a line that was previously passed. The new data for a preceding line is placed on the current line giving undesirable results. This limitation may be addressed in a future release.

The recommended extension for ASCII text PC files is **txt**.

## Adobe Portable Document Format

Adobe's PDF is a file format used to represent a document in a manner independent of the application software, hardware, and operating system used to create it. A PDF file contains a PDF document and other supporting data.

The files generated by SpoolMail can be read by any PDF capable viewer. Adobe's Acrobat reader is a PDF viewer that is distributed for free and is available for most major platforms making this transform useful when the users have differing platforms. You can download the latest version of Acrobat from [www.adobe.com](http://www.adobe.com).

On October 1, 2005, International Organization for Standardization (ISO) published *ISO 19005-1 Document Management - Electronic document file format for long term preservation - Part 1: Use of PDF 1.4 (PDF/A-1)*. This standard defines a format (PDF/A) for the long-term archiving of electronic documents and is based on the PDF Reference Version 1.4 (implemented in Adobe Acrobat 5). The files generated by SpoolMail optionally conform to this standard.

## Font Processing

When converting spooled files SpoolMail processes external print resources such as page segments and overlays. By default, fonts are mapped to one of the fonts built in to Adobe's Acrobat reader. The built in fonts are:

- Courier (including bold, italic and bold italic)
- Helvetica (including bold, italic and bold italic)
- Times (including bold, italic and bold italic)
- Symbol

For host resident fonts, that is fonts specified using coded font names such as XZ421001 or specified using character set and codepage names such as CZ4200 and T1V10037, you can improve the font fidelity (at the expense of file size) by specifying PDFNTIMB(\*TYPE1 \*TYPE3) on the PDF font imbedding parameter. Imbedding fonts includes a copy of the font's definition in the generated PC file.

For printer resident fonts, that is fonts specified using font global IDs such as **11**, you can convert to and imbed IBM i's host resident printer emulation fonts (at the expense of file size) by specifying PDFNTIMB(\*FGID) on the PDF font imbedding parameter. Imbedding fonts includes a copy of the font's definition in the generated PC file.

## Text positioning

Most IBM i spooled files use absolute text positioning operations which are processed exactly. For spooled files and print resources that contain relative moves, use blank padding to position text, or underline variable pitch text, positional accuracy can be improved at the expense of processing time by specifying TXTRELPOS(\*EXACT) or TXTRELPOS(\*EXACTMOD) on the Text relative positioning parameter.

## Document Security

PDF documents can be encrypted to protect their contents from unauthorized access. An encrypted PDF document has two passwords: an owner password and a user password. The PDF document also specifies operations that should be restricted even when the PDF document is decrypted. When opening an encrypted PDF document, Adobe's Acrobat Reader prompts for a password, if one is required. When the correct user password is supplied, the PDF document is opened and decrypted but operations are restricted; when the owner password is supplied, all operations are allowed. The owner password is required to change these passwords and restrictions.

A PDF document is encrypted whenever a user or owner password or restrictions are supplied for the PDF document. However, a user is prompted for a password on opening a PDF document only if the PDF document has a user password.

## File Signing

The PDF documents produced can be, optionally, digitally signed. The signature included in the PDF document allows the identity of the author to be validated and provides additional assurance that the PDF document has not been tampered with after it was signed.

## Document Open Options

PDF documents can be configured to control the behavior of Acrobat when the document is opened. The configuration settings are the same as those found in the full version of Acrobat under File > Document Properties > Open Options. With the settings, you can control the Initial View, Window Options, and User Interface Options in

effect when the document is opened. You can for example configure the document to hide the Acrobat menu bar, tool bar and window controls and to display in full screen mode when it is opened.

## Bookmarks

When converting spooled files SpoolMail generates bookmarks based on the "PDF bookmark style" PDFBKMSTY() and "PDF bookmark data source" PDFBKMSRC() command parameters. These specify what data to use to produce bookmarks in the generated PDF file. The bookmarks provide easy navigation to specific portions of the report. See > Adding Bookmarks To PDF Files in the Implementation chapter for more information.

## Transform Specification

You specify PDF conversion by specifying one of the following on the TRANSFORM() parameter:

<b>*PDFLETTER</b>	for 8.5" x 11" paper size
<b>*PDFLEGAL</b>	for 8.5" x 14" paper size
<b>*PDFSTATEMENT</b>	for 5.5" x 8.5" paper size
<b>*PDFEXECUTIVE</b>	for 7.25" x 10.5" paper size
<b>*PDFLEDGER</b>	for 11" x 17" paper size
<b>*PDFA5</b>	for A5 paper size
<b>*PDFA4</b>	for A4 paper size
<b>*PDFA3</b>	for A3 paper size
<b>*PDFB5</b>	for B5 paper size
<b>*PDFB4</b>	for B4 paper size
<b>*PDFLETTERLEGAL</b>	for 8.5" x 11" paper size in drawer 1 and 8.5" x 14" paper size in drawer 2.
<b>*PDFLEGALLETTER</b>	for 8.5" x 14" paper size in drawer 1 and 8.5" x 11" paper size in drawer 2.
<b>*PDFPAGESIZE</b>	for the page size defined by the spooled file's attributes.

The transforms to generate PDF/A are:

<b>*PDFALETTER</b>	for 8.5" x 11" paper size
<b>*PDFALEGAL</b>	for 8.5" x 14" paper size
<b>*PDFASTATEMENT</b>	for 5.5" x 8.5" paper size
<b>*PDFAEXECUTIVE</b>	for 7.25" x 10.5" paper size
<b>*PDFALEDGER</b>	for 11" x 17" paper size
<b>*PDFAA5</b>	for A5 paper size
<b>*PDFAA4</b>	for A4 paper size
<b>*PDFAA3</b>	for A3 paper size
<b>*PDFAB5</b>	for B5 paper size
<b>*PDFAB4</b>	for B4 paper size
<b>*PDFALTRLGL</b>	for 8.5" x 11" paper size in drawer 1 and 8.5" x 14" paper size in drawer 2.
<b>*PDFALGLLTR</b>	for 8.5" x 14" paper size in drawer 1 and 8.5" x 11" paper size in drawer 2.

## Double Byte Character Set Enabled

The conversion is DBCS enabled for Chinese/Japanese/Korean, specify a target CCSID of \*UNICODE. You must have the appropriate Adobe "Asian Font Pack" installed with Acrobat Reader or an Asian language specific version of Acrobat Reader Installed. You can download Asian Font Packs from [www.adobe.com](http://www.adobe.com).

## Miscellaneous

The recommended extension for Portable Document Format PC files is **pdf**.

---

## Microsoft Rich Text Format

Microsoft's RTF Specification provides a format for text and graphics interchange that can be used with different output devices, operating environments, and operating systems. The generated RTF uses the ANSI character set to control the representation and formatting of a document, both on the screen and in print. With the RTF Specification, documents created under different operating systems and with different software applications can be transferred between those operating systems and applications.

The generated RTF file specifies Courier New as the font. The font size is reduced if necessary to fit spooled file pages onto RTF pages. The data in the spooled file is converted from EBCDIC to ASCII based on the values specified for the source and target CCSID parameters.

The generated file can be read by any RTF capable viewer. Most word processors can read RTF encoded files making this transform useful when the recipient has a word processor. Naturally enough, Microsoft's Word has a very good RTF implementation while the quality of other implementations varies. Word Pad is capable of reading RTF files, however it discards most of the page format information such as margins and orientation.

You specify this conversion by specifying one of the following on the TRANSFORM() parameter:

<b>*RTFLETTER</b>	for 8.5" x 11" paper size
<b>*RTFLEGAL</b>	for 8.5" x 14" paper size
<b>*RTFSTATEMENT</b>	for 5.5" x 8.5" paper size
<b>*RTFEXECUTIVE</b>	for 7.25" x 10.5" paper size
<b>*RTFLEDGER</b>	for 11" x 17" paper size
<b>*RTFA5</b>	for A5 paper size
<b>*RTFA4</b>	for A4 paper size
<b>*RTFA3</b>	for A3 paper size
<b>*RTFB5</b>	for B5 paper size
<b>*RTFB4</b>	for B4 paper size

The recommended extension for Rich Text Format PC files is **rtf**.

---

## Hyper Text Markup Language

Hyper Text Markup Language (HTML) is the file format of the World Wide Web and is used to represent a document in a manner independent of the application software, hardware, and operating system used to create it. An HTML file contains HTML tags and the content of the spooled file. The generated file can be view by any web browser, making this transform useful when the users have differing platforms.

### Transform Specification

You specify HTML conversion by specifying one of the following on the TRANSFORM() parameter:

<b>*HTMLBASIC</b>	A very simple, fixed, conversion
<b>*HTMLCSS</b>	An XHTML 1.0 based conversion which allows styling

#### \*HTMLBASIC

SpoolMail generates a HTML file that specifies a fixed pitch font. The font size is determined by SpoolMail's default settings. The print data in the spooled file is converted from EBCDIC based on the value specified in the source and target CCSID parameters. Each page is placed in a row of a single column table with a border. Only the print data is converted. Images, overlays, page segments, etc. are not converted. The recommended target CCSID is \*UTF8.

#### \*HTMLCSS

This conversion is an update of \*HTMLBASIC that reflects changes to the standards over the years and allows you to control appearance through a style sheet.

SpoolMail generates a HTML file by converting print data in the spooled file from EBCDIC to UTF8 based on the value specified in the source CCSID parameter. Target CCSID is ignored. Each page is placed in a row of a single column table, and only the print data is converted. Images, overlays, page segments, etc. are not converted. The conversion is DBCS enabled.

The contents of the file specified on the Style sheet (HTMCSS) parameter are copied, unaltered and uninspected, into the generated html. The contents are placed within a <style></style> tag pair. If no style sheet is specified, a basic style sheet is generated.

### Miscellaneous

The recommended extension for Hyper Text Markup Language PC files is **html** or **htm**.

---

## Tag Image File Format

Tag Image File Format is a widely used format for storing image data.

SpoolMail generates a TIFF file by passing the contents of the spooled file to the IBM i Host Print Transform Function and storing the converted data stream in a PC file which is sent as an attachment.

The generated file can be view by most image viewing or editing applications. Our experience is that the IBM i support is some what flakey, and that some image viewing applications have problems with multi page TIFF files. Test your results before placing this transform into production.

You specify this conversion by specifying one of the following on the TRANSFORM() parameter:

<b>*TIFFLETTER</b>	Group 4 specification conversion with letter size paper implied.
<b>*TIFFLEGAL</b>	Group 4 specification conversion with legal size paper implied.
<b>*TIFFEXECUTIVE</b>	Group 4 specification conversion with executive size paper implied.
<b>*TIFFLEDGER</b>	Group 4 specification conversion with ledger size paper implied.
<b>*TIFFA3</b>	Group 4 specification conversion with A3 size paper implied.
<b>*TIFFA4</b>	Group 4 specification conversion with A4 size paper implied.
<b>*TIFFA5</b>	Group 4 specification conversion with A5 size paper implied.
<b>*TIFFB4</b>	Group 4 specification conversion with B4 size paper implied.
<b>*TIFFB5</b>	Group 4 specification conversion with B5 size paper implied.
<b>*TIFFCONT80</b>	Group 4 specification conversion with continuous 8.0 inch paper implied.
<b>*TIFFCONT132</b>	Group 4 specification conversion with continuous 13.2 inch paper implied.
<b>*TIFF</b>	Group 4 specification
<b>*TIFFPB</b>	Pack Bit specification

The recommended extension for Tag Image File Format PC files is tif.

---

## IBM i Host Print Transform

IBM i's Host Print Transform converts \*AFPDS or \*SCS print data streams and generates an ASCII print data stream for a number of IBM and non-IBM printer. For example, you can print Advanced Function Presentation (AFP) text, bar codes, image, overlays, and page segments to Hewlett Packard PCL and Lexmark PPDS page printers. To generate the different ASCII data streams, the host print transform function uses IBM i system objects that describe characteristics of a particular ASCII printer.

SpoolMail generates a HPT file by passing the contents of the spooled file to the Host Print Transform Function and storing the converted data stream in a PC file which is sent as an attachment. The transform performed is controlled by the TRANSFORM() and WSCST() parameters of the Send Spool Mail (SNDSPLMAIL) command. The values specified in the Send Spool Mail (SNDSPLMAIL) command's Target coded character set id (CCSID), and Source coded character set id (SRCCSID) parameters are ignored.

The generated file can be copied by the recipient directly to a printer port for printing. For example, if the attached file's name is T103609.HPT then the following DOS command prints the file to printer port LPT1:

```
copy t103609.hpt lpt1:
```

You specify this conversion by specifying one of the Host Print Transforms such as TRANSFORM(\*HPIIIP). The recommended extension for Host Print Transform PC files is hpt. For complete information on the available Host Print Transforms see the Manufacturer Type and Model (MFRTYPMDL Parameter) of the CRTDEVPRT command.

---

## No Conversion

SpoolMail can copy a spooled file's print data stream directly to a PC file without conversion. The data in the spooled file is not converted, and the Send Spool Mail (SNDSPLMAIL) command's Target coded character set id (CCSID), and Source coded character set id (SRCCSID) parameters are ignored. This is most useful for delivering spooled files with a \*USERASCII print data stream but works with any spooled file.



The generated file can be copied by the recipient directly to a printer port for printing. For example, if the attached file's name is T103609.SPL then the following DOS command prints the file to printer port LPT1:

```
copy t103609.spl lpt1:
```

You specify this conversion by specifying TRANSFORM(\*NONE). The recommended extension for no conversion PC files is spl, unless a more accurate extension is available for the contents of the file.

---

## Adobe PostScript

Adobe's PostScript is a widely used page definition language. IBM i includes an application programming interface (API) for converting Advanced Function Presentation Data Streams (AFPDS) into PostScript. The API processes the following AFPDS objects:

- Document
- Presentation page
- Presentation text data
- IM1 image data
- IO image (IOCA) commands
- Presentation Text 2 (PT2) text commands
- Overlay resources
- Page segment resources

The API does not process the following objects:

- Graphic data (GOCA) commands
- Bar code (BCOCA) commands
- Double-byte character set (DBCS) fonts
- Spooled files that are larger than 16 Meg
- Generated PostScript larger than 16 Meg

AFP that is not supported is ignored, and no warning or error message is sent to the user. Additionally the printed output may appear different than the same spooled file printed on an AFP capable printer.

SpoolMail generates a PostScript file by passing the contents of the spooled file to the IBM i API and storing the converted data stream in a PC file. The generated file has the CCSID specified in the Send Spool Mail (SNDSPLMAIL) command's Target coded character set id (CCSID) parameter. The Source coded character set id (SRCCSID) parameter is ignored.

The generated file can be copied directly to a PC printer port for printing. For example, if the PC file's name is T103609.PS then the following DOS command prints the file to printer port LPT1:

```
copy t103609.ps lpt1:
```

You specify this conversion by specifying TRANSFORM(\*POSTSCRIPT). The recommended extension for PostScript PC files is ps.

---

## IBM's Final Form Text

Final-Form Text is an extension of SCS. It is used within the OfficeVision Office environment and defines how the data streams that represent a document to be printed are organized. Each line of the input spooled file is formatted as Final Form Text based on the value specified in the Send Spool Mail (SNDSPLMAIL) command's Source coded character set id (SRCCSID) parameter. The value specified Target coded character set id (CCSID) parameter is ignored.

The generated file can be read by any FFT capable viewer. Typically this is OfficeVision.

You specify this conversion by specifying TRANSFORM(\*FFTBASIC).

The recommended extension for Final Form Text PC files is `fft`.

---

## **AFP Print File**

IBM's Advanced Function Presentation (AFP) Workbench Viewer is a platform for the integration of AFP-enabling applications and services. The Viewer provides the ability to browse AFP formatted print files.

SpoolMail generates an AFP Print File by copying the contents of the spooled file and inserting any related page segments and overlays and optionally when `*AFPPRINTFILE2` is used, fonts. Since the Afp Workbench Viewer "thinks" in EBCDIC, the Send Spool Mail (SNDSPLMAIL) command's Target coded character set id (CCSID), parameter is ignored. The resulting PC file is ready for viewing with AFP Workbench Viewer.

You specify this conversion by specifying `TRANSFORM(*AFPPRINTFILE)` or `TRANSFORM(*AFPPRINTFILE2)`. The recommended extension for AFP Print Files is `afp`.

---

## Chapter 7 Commands

---

### What's In This Chapter

This chapter describes the control language (CL) commands supplied by SpoolMail. The commands are arranged in alphabetic order by command name (mnemonic). Each description includes environment and threadsafe classification, a brief general description, detailed parameter explanations, examples and message information. Additional explanatory material can be found in the *Programming > Control Language > CL Concepts > CL Commands > CL command information and documentation* topic in the IBM i Information Center at <http://publib.boulder.ibm.com/series/>.

---

## Archive Spooled File (ARCSPLF)

Where allowed to run: All environments (\*ALL)

Threadsafe: No

The Archive Spooled File (ARCSPLF) command creates a spooled file archive which can be saved and restored, and from which the spooled file can be retrieved (recreated).

---

### Parameters

Keyword	Description	Choices	Notes
<b>FILE</b>	Spooled file name	<i>Name</i>	Required, Positional 1
<b>ARC</b>	Spooled file archive	<i>Qualified object name</i>	Optional
	Qualifier 1: Spooled file archive	<i>Name</i> , <b>*GEN</b>	
	Qualifier 2: Library	<i>Name</i> , <b>*CURLIB</b>	
<b>JOB</b>	Job name	Single values: <i>_</i> Other values: <i>Qualified job name</i>	Optional
	Qualifier 1: Job name	<i>Name</i>	
	Qualifier 2: User	<i>Name</i>	
	Qualifier 3: Number	000000-999999	
<b>SPLNBR</b>	Spooled file number	1-999999, <b>*ONLY</b> , <b>*LAST</b>	Optional

---

### Spooled file name (FILE)

Specifies the name of the spooled file to process. CHAR(10)

This is a required parameter.

***name*** Specify the name of the spooled file.

---

### Spooled file archive (ARC)

Specifies the name of the archive that contains the spooled file.

#### Element 1: Spooled file archive

**\*GEN** Generate the archive name from the supplied FILE, JOB, and SPLNBR parameters.

***name*** Specify the name of the archive.

#### Qualifier 2: Library

**\*CURLIB** Use the current library for the job. If no library is specified as the current library for the job, QGPL is used.

***name*** Specify the name of the library.

---

### Job name (JOB)

Specifies the job that contains the spooled file.

#### Single values

***\_*** The job that issued the command.

#### Qualifier 1: Job name

***name*** Specify the name of the job. CHAR(10)

#### Qualifier 2: User

***name*** Specify the name that identifies the user profile under which the job is run. CHAR(10)

### Qualifier 3: Number

**000000-999999** Specify the system assigned job number. CHAR(6)

---

### Spooled file number (SPLNBR)

Specifies the number of the spooled file. INT(4)

<b>*LAST</b>	The highest numbered spooled file with the specified file name is used.
<b>*ONLY</b>	The number of the only spooled file with the specified file name is used.
<b>1-999999</b>	Specify the number of the spooled file.

---

### Examples

#### Example 1:

```
ARCSPLF FILE(QSYSPRT)
```

This command archives the last spooled file named QSYSPRT. The current job is searched to locate the file. The archive is placed in the job's \*CURLIB.

#### Example 2:

```
ARCSPLF FILE(QPQUPRFIL) ARC(QGPL/*GEN) SPLNBR(3)
```

The file named QPQUPRFIL, which is spooled file number 3 in the job executing this command, is archived. The archive is placed in library QGPL.

---

### Error messages

#### \*ESCAPE messages

**SPLA106** Unable to archive spooled file for job //.

---

## Change Device Gumbo Printer (CHGDEVGLP)

**Where allowed to run:** All environments (\*ALL)

**Threadsafe:** No

The Change Device Gumbo Printer (CHGDEVGLP) command prompts you to change the source command executed by a Gumbo logical printer.

---

### Parameters

Keyword	Description	Choices	Notes
<b>DEV</b>	Device description	<i>Name</i>	Required, Positional 1
<b>START</b>	Start printer writer now	<b>*YES</b> , *NO	Optional

---

### Device description (DEV)

Specifies the name of the device description.

This is a required parameter.

***name***                      Specify the name of the device.

---

### Start printer writer now (START)

Specifies whether a printer writer is automatically started (restarted if it is active) when the changes are complete.

**Note:** The changes do not take affect until the printer writer is restarted.

**\*YES**                      A printer writer is started immediately.

**\*NO**                        A printer writer is not started now.

---

### Examples

#### Example 1:

```
CHGDEVGLP  DEV (GPL01)
```

This command changes a Gumbo logical printer with named GLP01.

---

## Change SpoolMail Authorization (CHGSM1AUT)

**Where allowed to run:** All environments (\*ALL)

**Threadsafe:** No

The Change SpoolMail Authorization (CHGSM1AUT) command changes the authorization code for SpoolMail. The command is used to extend a demonstration period or to permanently authorize SpoolMail for a system or a partition.

The proposed authorization information is tested against the authorization algorithm to confirm that it will authorize SpoolMail. If the test fails, no change is made.

---

### Parameters

Keyword	Description	Choices	Notes
<b>AUTH</b>	Authorization code	<i>Hexadecimal value</i>	Required, Positional 1
<b>EXPDAT</b>	Expiration date (CCYYMMDD)	<i>Character value, <u>*NONE</u></i>	Optional, Positional 2
<b>LICTYP</b>	License type	<u>*SYS</u> , *LPAR	Optional, Positional 3
<b>PRCMAX</b>	Processor maximum capacity	<i>Decimal number</i>	Optional, Positional 4

---

### Authorization code (AUTH)

Specifies the authorization code to use. The authorization code is 8 hex digits that may be entered in upper or lower case.

This is a required parameter.

***hexadecimal-value*** Specify the case insensitive authorization code.

---

### Expiration date (CCYYMMDD) (EXPDAT)

Specifies the date on which the authorization expires.

**\*NONE** The authorization is permanent.

***date*** The date on which the authorization expires in CCYYMMDD format.

---

### License type (LICTYP)

Specifies the type of license that is authorized.

**\*SYS** The authorization is for a system wide license, which enables any and all partitions on the system but is specific to the processor group.

**Note:** The authorization code must be entered in each partition.

**\*LPAR** The license is specific to one of the partitions on the system and specific to a number of processors within the partition. A partition license must be entered in the partition for which it is intended.

---

### Processor maximum capacity (PRCMAX)

Specifies the maximum processor capacity for which the partition is licensed. The value is expressed in terms of processors where 1.00 is 100% of a processor's capacity or the same as 1 processor, .50 is 50% of a processor's capacity or .5 processors, 2.00 is 200% of a processor's capacity or 2 processors, etc.

***decimal-number*** Specify the maximum processor capacity.

---

## Examples

### Example 1:

```
CHGSM1AUT AUTH(01234567)
```

This command changes the authorization code to a permanent system wide license code.

### Example 2:

```
CHGSM1AUT AUTH(01234567) LICTYP(*LPAR) PRCMAX(1.3)
```

This command changes the authorization code to a permanent partition only license code for 1.3 processors in the current partition.

---

## Error messages

### \*ESCAPE messages

**AUT9909** SpoolMail authorization change was not performed.



## Change SpoolMail Default (CHGSM1DFT)

Where allowed to run: All environments (\*ALL)

Threadsafe: No

The Change SpoolMail Default (CHGSM1DFT) command changes values used by SpoolMail to control processing and other activities.

### Parameters

Keyword	Description	Choices	Notes
<b>MARGIN</b>	Margins in hundredths	<i>Element list</i>	Optional, Positional 1
	Element 1: Left	0-255, <u>*SAME</u>	
	Element 2: Right	0-255, <u>*SAME</u>	
	Element 3: Top	0-255, <u>*SAME</u>	
	Element 4: Bottom	0-255, <u>*SAME</u>	
<b>PDFDEFLATE</b>	Compress PDF files	*NO, *YES, <u>*SAME</u> , X'00', N, S	Optional, Positional 2
<b>HTMFNTSIZ</b>	*HTMLBASIC Font Size	*MINUS3, *MINUS2, *MINUS1, *PLUS0, *PLUS1, *PLUS2, *PLUS3, <u>*SAME</u> , '', *, A, B, C, D, E, F	Optional, Positional 3
<b>REFPRTDEV</b>	Reference printer device	<i>Name</i> , <u>*SAME</u> , *SYSVAL, *AFPYES, *HPTASCII, *HPTOLD, *HPT, *NONE	Optional, Positional 4
<b>REFOFFSET</b>	Refprtdev offset default	<i>Element list</i>	Optional, Positional 5
	Element 1: Left	<i>Integer</i> , <u>*SAME</u>	
	Element 2: Top	<i>Integer</i> , <u>*SAME</u>	
<b>REFCORRECT</b>	Refprtdev offset correction	<i>Element list</i>	Optional, Positional 6
	Element 1: Left	<i>Integer</i> , <u>*SAME</u>	
	Element 2: Top	<i>Integer</i> , <u>*SAME</u>	
<b>PDFNPBOVL</b>	PDF apply noprtbdr to overlay	*NO, *YES, <u>*SAME</u> , '', Y, S	Optional, Positional 7
<b>PDFFNTIMB</b>	PDF font imbedding	Single values: <u>*SAME</u> , *NONE, *TYPES13 Other values (up to 5 repetitions): <u>*SAME</u> , *NONE, *TYPE3, *TYPE1, *TYPES13, *FGID, *TRUETYPE, 0, 1, 2, 3, 4, 8, -1	Optional, Positional 8
<b>TXRELPOS</b>	Text relative positioning	*ESTIMATE, *EXACT, *EXACTMOD, <u>*SAME</u> , 0, 1, 3, 226	Optional, Positional 9
<b>ORIGINATOR</b>	Originator user ID	Single values: <u>*SAME</u> , *CURRENT Other values: <i>Element list</i>	Optional, Positional 10
	Element 1: User ID	<i>Character value</i>	
	Element 2: Address	<i>Character value</i>	
<b>PDFIMG PBL</b>	PDF image process blending	Single values: <u>*SAME</u> , *RECOMMENDED Other values (up to 3 repetitions): <u>*SAME</u> , *RECOMMENDED, *NOPREBLEND32, *PREBLEND32, *NOPREBLEND4, *PREBLEND4, *BLENDOVL, *NOBLENDOVL, 0, 1, 2, 64	Optional, Positional 11
<b>SIXSIC</b>	Spool Index SCS Control	*ORDINAL, *RELATIVE, <u>*SAME</u> , 0, 64, -1	Optional, Positional 12
<b>SGNKEY</b>	Signing key	Single values: <u>*SAME</u> , *NONE Other values: <i>Element list</i>	Optional, Positional 13
	Element 1: Application ID	<i>Character value</i>	
<b>PDFSGNKEY</b>	PDF document signing key	Single values: <u>*SAME</u> , *NONE Other values: <i>Element list</i>	Optional, Positional 14
	Element 1: Application ID	<i>Character value</i>	
<b>GROPRCDFT</b>	Graphic processor default	*PRECISION1, *PRECISION2, <u>*SAME</u> , SAME, PRC1, PRC2	Optional, Positional 15
<b>GATEWAY</b>	Obsolete	Single values: <u>*SAME</u> , *NONE Other values: <i>Element list</i>	Optional, Positional 17
	Element 1: User ID	<i>Character value</i>	
	Element 2: Address	<i>Character value</i>	
<b>NOPRTBDR</b>	Obsolete	<i>Element list</i>	Optional, Positional 16
	Element 1: .	<i>Integer</i> , <u>*SAME</u>	
	Element 2: .	<i>Integer</i> , <u>*SAME</u>	

---

## Margins in hundredths (MARGIN)

Margins are used when converting a spooled file. The values for margins are entered in hundredths. For example, 100 means one inch and 25 means 1/4 inch.

**Note:** Not all transforms require or use the margin setting. Currently the \*RTF transforms do use the margin setting.

**Note:** In previous releases, margins were used to affect the conversion of \*SCS and \*IPDS to PDF. This function is now supplied by the "Refprtdev offset default" (REFOFFSET) and "Reference printer device" (REFPRTDEV) parameters.

<b>*SAME</b>	The value is not changed.
<b>margin</b>	Specify the margin in hundredths.

---

## Compress PDF files (PDFDEFLATE)

Specifies whether or not to use compression when using any of \*PDF conversions. When compression is used, the file is smaller but must be viewed with Adobe's Acrobat Reader 3.0 or higher. When compression is not used, older versions of Adobe's Acrobat Reader can be used to view the file.

<b>*SAME</b>	The value is not changed.
<b>*YES</b>	Compression is performed.
<b>*NO</b>	Compression is not performed.

---

## \*HTMLBASIC Font Size (HTMFNTSIZ)

Specifies the font size specification used by the \*HTMLBASIC transform. This value is used on the "<FONT SIZE=..." tag in the generated HTML.

<b>*SAME</b>	The value is not changed.
<b>*MINUS3</b>	Font is three increments smaller than the base font.
<b>*MINUS2</b>	Font is two increments smaller than the base font.
<b>*MINUS1</b>	Font is one increment smaller than the base font.
<b>*PLUS0</b>	Font is the size as the base font.
<b>*PLUS1</b>	Font is one increment larger than the base font.
<b>*PLUS2</b>	Font is two increments larger than the base font.
<b>*PLUS3</b>	Font is three increments larger than the base font.

---

## Reference printer device (REFPRTDEV)

The reference printer device is used when processing a spooled file. If an attribute of a spooled file specifies \*DEVVD, the reference printer device's description is retrieved to determine the value that is substituted for \*DEVVD. The reference printer device, in conjunction with the Refprtdev offset default and Refprtdev offset correction values, is also used to determine the correct positioning during processing.

<b>*SAME</b>	The value is not changed.
<b>*SYSVAL</b>	The system determines the reference printer device name from the QPRTDEV system value.
<b>*AFPYES</b>	Spooled files are processed as if an *IPDS AFP(*YES) printer were specified.
<b>*HPTASCII</b>	Spooled files are processed as if a Host Print Transform described ASCII printer were specified.
<b>*HPTOLD</b>	Included for backward compatibility, use *HPTASCII.
<b>*HPT</b>	Included for backward compatibility, same as *HPTOLD.
<b>*NONE</b>	Included for backward compatibility, same as *AFPYES.
<b>name</b>	Specify the name of the reference printer device.

---

## Refprtdev offset default (REFOFFSET)

Specifies the default offset values (in 1/1440ths of an inch) to use if these can not be determined from the printer device specified on the REFPRTDEV parameter.

The Refprtdev offset default values represent the offset from the top left corner of the physical paper to the top left corner of the printable area for the printer:

- For HPT printers, this offset is often referred to as a "no print border".
- For \*IPDS printers, this offset is often referred to as an "unprintable area".
- When set to 0s, a printer that is capable of printing edge-to-edge and with the capability turned on, is implied.
- Under most circumstances, the offset values move text and other page elements without moving page overlays.
- A typical IBM \*IPDS printer has an unprintable area of 227 (1440ths of an inch or 4mm) when edge-to-edge printing is turned off.
- A typical HP Laser printer has a no print border of 240 (1440ths of an inch or 1/6").

During processing, the Reference printer device is used to determine the offset from the top left corner of the physical paper to the top left corner of the printable area. When the values can not be determined from the Reference printer device, the values specified in the "Refprtdev offset default" (REFOFFSET) parameter are used.

Additional information on this topic can be found in the Redbook *Printing V SG24-4389* (and its replacement *Printing VI SG24-6250*) available at <http://publib.boulder.ibm.com/series/>.

**Note:** Previously, some of the function provided by the REFPRTDEV and REFOFFSET parameters was provided by the MARGIN and NOPRTBDR parameters. See the help text for them for further details.

**\*SAME**            The value is not changed.  
**integer**           Specify the offset in 1/1440ths of an inch.

---

### Refprtdev offset correction (REFCORRECT)

Specifies offset correction values (in 1/1440ths of an inch), used to fix disparities between the physical hardware and its logical description.

The Refprtdev offset correction (REFCORRECT) parameter should almost always be set to zero. In two obscure cases values should be entered to correct alignment problems in the generated output.

1. If the spooled file normally prints correctly on an \*IPDS printer that has a page offset value (usually set through the front panel), enter the same page offset values here.
2. If the spooled file normally prints correctly on a Workstation Customizing Object defined printer (that is, a custom WSCST is specified on the device description), and if the WSCST inaccurately specifies the device's no print border, enter a value here. The value to enter is the actual no print border minus the no print border inaccurately specified in the WSCST.

If you are not sure that these cases apply, enter zeros.

**\*SAME**            The value is not changed.  
**integer**           Specify the offset correction in 1/1440ths of an inch.

---

### PDF apply noprtbdr to overlay (PDFNPBOVL)

Specifies how to handle overlays that fall into a Host Print Transform described printer's no print border when using any of the \*PDF conversions.

**\*SAME**            The value is not changed.  
**\*YES**             Overlays are moved out of the no print border.  
**\*NO**              Overlays are located at their "natural" position.

---

## PDF font imbedding (PDFNTIMB)

Specifies the default setting for font imbedding. Font imbedding specifies, by font type, which font definitions are included in the generated PDF file. Imbedding fonts improves the fidelity of the PDF at the expense of file size.

<b>*SAME</b>	The value is not changed.
<b>*NONE</b>	No font definitions are included in the file. All fonts are mapped to Acrobat built-ins.
<b>*TYPE1</b>	Outline font resources are imbedded in the file.
<b>*TYPE3</b>	Raster font resources are subsetted and imbedded in the file.
<b>*TYPES13</b>	Both raster and outline font resources are imbedded in the file.
<b>*FGID</b>	Printer resident font specifications are converted to host resident printer emulation font resources and these are imbedded in the file.
<b>*TRUETYPE</b>	TrueType and OpenType fonts are imbedded in the file.

---

## Text relative positioning (TXTRELPOS)

Specifies the accuracy with which relative text positioning operations are processed. Most IBM i spooled files use absolute text positioning operations which are processed exactly. For spooled files and print resources that contain relative moves, use blank padding to position text, or underline variable pitch text, positional accuracy can be improved at the expense of processing time.

<b>*SAME</b>	The value is not changed.
<b>*ESTIMATE</b>	Relative text positions are calculated using the font's average character increment.
<b>*EXACT</b>	Relative text positions are calculated using each character's exact character increment in the host resident font.
<b>*EXACTMOD</b>	Relative text positions are calculated using each character's exact character increment in the host resident font. <b>Note:</b> This is the same as *EXACT but uses a modified positioning algorithm employed by some printers.

---

## Originator user ID (ORIGINATOR)

The Originator User ID is the value used when \*DEFAULT is specified on Originator (USRID) parameter.

<b>*SAME</b>	The value is not changed.
<b>*CURRENT</b>	The user id of the user profile running the command is used.
<b><i>originator-user-id</i></b>	Specify the network id used as the *DEFAULT value.

---

## PDF image process blending (PDFIMGPBL)

Specifies the default setting for image process blending which gives you control over image blending in the generated PDF.

The **\*NOPREBLEND32**, **\*PREBLEND32**, **\*NOPREBLEND4**, **\*PREBLEND4** parameter values define the way in which banded (usually color) 32 bit and 4 bit image data is managed. When **\*NOPREBLEND32** and **\*NOPREBLEND4** are specified, the generated PDF takes advantage of the blending facilities implemented in Acrobat 5.0 and higher to significantly reduce the IBM i processing required to render full color images. However, these images do not display properly in Acrobat 4 and below, 4 bit images may be too dark, and the file size may be larger and the file may take longer to display. With **\*PREBLEND32** and **\*PREBLEND4** you can specify that additional processing be performed on your system to "pre-blend" images before placing them into the generated PDF. In particular, color matching for pure 4 bit images may also be improved. The recommended settings are **\*NOPREBLEND32** and **\*PREBLEND4**.

<b>*SAME</b>	The value is not changed.
<b>*RECOMMENDED</b>	Use the recommended settings of <b>*NOPREBLEND32</b> <b>*PREBLEND4</b> .
<b>*NOPREBLEND32</b>	Do not pre-blend 32 bit images.
<b>*PREBLEND32</b>	Use image pre-blending on 32 bit images.
<b>*NOPREBLEND4</b>	Do not pre-blend 4 bit images.
<b>*PREBLEND4</b>	Use image pre-blending on 4 bit images.

**Note:** \*BLENDOVL and \*NOBLENDOVL are obsolete and have no effect.

---

## Spool Index SCS Control (SIXSIC)

Specifies the spooled file indexing method for \*SCS files in the presence of lines per inch (LPI) changes or font changes within a page. Spooled file indexing occurs when line and position values are required to process a request. Examples are filtering, or specifying page data. This setting can only affect the determination of line numbers if the spooled file contains \*SCS and if the LPI or font changes within a page.

<b>*SAME</b>	The value is not changed.
<b>*ORDINAL</b>	This is the recommended value. Line numbers and position numbers are calculated using a deterministic, repeatable method that typically returns line and position values as they were specified in the DDS for the printer file.
<b>*RELATIVE</b>	This value gives the original indexing behavior. The method returns line and position numbers that may vary from page to page for data that otherwise appears in the same position. The variance depends on the data's position relative to preceding data on the page.

---

## Signing key (SGNKEY)

Specifies the default digital certificate used to sign email.

The signature included with the email allows the recipient to validate the identity of the sender and provides additional assurance that the email has not been tampered with after it is signed.

A certificate is referenced by specifying the name (Application ID) of an object signing application created using IBM i's Digital Certificate Manager.

<b>*SAME</b>	The value is not changed.
<b>*NONE</b>	No signing operation is performed.
<b><i>application-id</i></b>	Specify the application identifier to use in the signing operation.

---

## PDF document signing key (PDFSGNKEY)

Specifies the digital certificate used to sign Portable Document Format (PDF) files.

The PDF documents produced can be, optionally, digitally signed. The signature included in the PDF document allows the identity of the author to be validated and provides additional assurance that the PDF document has not been tampered with after it was signed.

A certificate is referenced by specifying the name (Application ID) of an object signing application created using IBM i's Digital Certificate Manager.

<b>*SAME</b>	The value is not changed.
<b>*NONE</b>	No signing operation is performed.
<b><i>application-id</i></b>	Specify the application identifier to use in the signing operation.

---

## Graphic processor default (GROPRCDFT)

Specifies the default settings for the G:OCA processing engine. Most printers implement Precision 1 as the device drawing default and this is the recommended value. Most graphic objects specify the precision needed to correctly render them, and don't depend on a printer's drawing default. In the case where your graphic object does not specify a precision you can match the default supplied by your printer.

<b>*SAME</b>	The value is not changed.
<b>*PRECISION1</b>	Graphic engine device drawing default is 1=String precision.
<b>*PRECISION2</b>	Graphic engine device drawing default is 2=Character precision.

---

## Internet Gateway ID (GATEWAY)

**Note:** This is an obsolete parameter that is no longer required to correctly process email. It is included to allow configuration of an SNADS SMTP route if desired. Unless you know you need this, you do not need this.

An Internet Gateway id is a specially configured network user id in the system distribution directory that switches SNADS distributions to SMTP.

<b>*SAME</b>	The value is not changed.
<b>*NONE</b>	The context switching internet gateway is disabled.
<b><i>internet-gateway-id</i></b>	Specify the network id used as a context switching internet gateway.

---

## PDF border correction 1440ths (NOPRTBDR)

This is an obsolete parameter whose value is no longer used and is ignored. Use REFOFFSET() instead.

---

### Examples

#### Example 1:

```
CHGSM1DFT  REFPRTDEV (PRT02)
```

This command changes the reference printer device to PRT02. The printer specific behavior is used as a reference in processing.

#### Example 2:

```
CHGSM1DFT  REFPRTDEV (*HPTASCII)
```

This command changes the reference printer device to PRT02. Processing emulates a Host Print Transform attached \*ASCII printer.

---

## Check SpoolMail Authorization (CHKSM1AUT)

Where allowed to run: All environments (\*ALL)  
Threadsafe: No

The Check SpoolMail Authorization (CHKSM1AUT) command executes SpoolMail's authorization verification function. This allows you to determine whether and how the product is authorized for use.

---

### Parameters

Keyword	Description	Choices	Notes
MSGQ	Message queue	Single values: <u>*NONE</u> Other values: <i>Qualified object name</i>	Optional, Positional 1
	Qualifier 1: Message queue	<i>Name</i>	
	Qualifier 2: Library	<i>Name</i> , <u>*LIBL</u> , *CURLIB	

---

### Message queue (MSGQ)

Specifies a message queue that should receive messages if the product is not permanently authorized.

#### Single values

\*NONE Messages are not sent to an external message queue.

#### Qualifier 1: Message queue

*name* Specify the name message queue that receives messages.

#### Qualifier 2: Library

\*LIBL All libraries in the thread's library list are searched.

\*CURLIB Use the current library for the job. If no library is specified as the current library for the job, QGPL is used.

*name* Specify the name of the library.

---

### Examples

#### Example 1:

```
CHKSM1AUT
```

This command executes SpoolMail's authorization verification function to determine whether and how the product is authorized for use.

#### Example 2:

```
CHKSM1AUT MSGQ(QSYSOPR)
```

This command executes SpoolMail's authorization verification function to determine whether and how the product is authorized for use. If the product is not permanently authorized for use, a failure message is sent to the system operator's message queue.

---

### Error messages

#### \*ESCAPE messages

**AUT9901** We're sorry, the SpoolMail demonstration period is over.  
**AUT9905** Unable to access machine information.  
**AUT9907** SpoolMail processor group change grace period has expired.  
**AUT9916** SpoolMail release upgrade grace period has expired.  
**AUT9918** We're sorry, more than 30 days have elapsed since the software was first installed.  
**AUT9921** SpoolMail unpartitioned system grace period has expired.  
**AUT9926** SpoolMail processor limit exceeded grace period has expired.  
**AUT9930** SpoolMail authorization check failed.





---

## Create Device Gumbo Printer (CRTDEVGLP)

Where allowed to run: All environments (\*ALL)

Threadsafe: No

The Create Device Gumbo Printer (CRTDEVGLP) command creates a device description for a Gumbo logical printer.

A Gumbo logical printer is a printer device that performs spooled file processing instead of printing on paper. As with other printer devices, you use IBM i's writer commands (WRKWTR, STRPRTWTR, ENDWTR, HLDWTR, etc.) and IBM i's configuration commands (WRKCFGSTS, VFYCFG, etc.) to control a Gumbo logical printer's operation.

When you create a Gumbo logical printer using the Create Device Gumbo Printer (CRTDEVGLP) command, a source file with the same name is create in library QUSRSYS. The source file contains a member with the same name as the printer and in the source member is a single Control Language (CL) command. As a Gumbo logical printer processes, it runs this command once for each spooled file in the output queue.

---

### Parameters

Keyword	Description	Choices	Notes
<b>DEV</b>	Device description	<i>Name</i>	Required, Positional 1
<b>PORT</b>	Port number	0-65535	Required, Positional 2
<b>ONLINE</b>	Online at IPL	<b>*YES</b> , *NO	Optional
<b>PRTERMSG</b>	Printer error message	<b>*INQ</b> , *INFO	Optional
<b>MSGQ</b>	Message queue	<i>Qualified object name</i>	Optional
	Qualifier 1: Message queue	<i>Name</i> , <b>OSYSOPR</b>	
	Qualifier 2: Library	<i>Name</i> , <b>*LIBL</b> , *CURLIB	
<b>START</b>	Start printer writer now	<b>*YES</b> , *NO	Optional
<b>TEXT</b>	Text 'description'	<i>Character value</i> , <b>*BLANK</b>	Optional
<b>AUT</b>	Authority	<i>Name</i> , <b>*LIBCRTAUT</b> , *CHANGE, *ALL, *USE, *EXCLUDE	Optional

---

### Device description (DEV)

Specifies the name of the device description.

This is a required parameter.

***name*** Specify the name of the device.

---

### Port number (PORT)

Specifies the port number of the Gumbo logical printer. Valid values range from 0 to 65535 and must be unique across all printer devices on the system which have device class \*LAN. You should also avoid "well known" and "registered" ports such as 25 and 9100. Otherwise, it does not matter what port number you specify.

This is a required parameter.

**0-65535** Specify the port number to use.

---

### Online at IPL (ONLINE)

Specifies whether this device is automatically varied on at initial program load (IPL).

**\*YES** This device is varied on automatically at IPL.

**\*NO** This device is not varied on automatically at IPL.

---

## Printer error message (PRERRMSG)

Specifies whether the device has inquiry messages or informational messages for recoverable errors.

<b>*INQ</b>	Inquiry messages are sent for recoverable errors.
<b>*INFO</b>	Informational messages are sent for recoverable errors.

---

## Message queue (MSGQ)

Specifies the qualified name of the message queue to which operational messages for this device are sent.

### Element 1: Message queue

<b><u>QSYSOPR</u></b>	Messages are sent to the QSYSOPR message queue.
<b>name</b>	Specify the name of the message queue.

### Qualifier 2: Library

<b>*LIBL</b>	All libraries in the thread's library list are searched.
<b>*CURLIB</b>	Use the current library for the job. If no library is specified as the current library for the job, QGPL is used.
<b>name</b>	Specify the name of the library.

---

## Start printer writer now (START)

Specifies whether a printer writer is automatically started as soon as the Gumbo logical printer is created.

<b>*YES</b>	A printer writer is started immediately.
<b>*NO</b>	A printer writer is not started now.

---

## Text 'description' (TEXT)

Specifies text that provides a brief description.

<b>*BLANK</b>	No text is specified.
<b>character-value</b>	Specify up to 50 characters of text enclosed in apostrophes.

---

## Authority (AUT)

Specifies the authority you are giving to users who do not have specific authority to the object, who are not on the authorization list, or whose group has no specific authority to the object.

<b>*LIBCRTAUT</b>	The authority for the object is the same as the value specified on the <b>Create authority</b> prompt (CRTAUT parameter) of the library in which the object is being created. If the value specified on the <b>Create authority</b> prompt (CRTAUT parameter) is changed, the new value will not affect any existing objects.
<b>*CHANGE</b>	Change authority allows the user to perform basic functions on the object, however, the user cannot change the object. Change authority provides object operational authority and all data authority.
<b>*ALL</b>	The user can perform all operations except those limited to the owner or controlled by authorization list management authority. The user can control the object's existence, specify the security for the object, change the object, and perform basic functions on the object. The user cannot transfer ownership of the object.
<b>*USE</b>	Use authority provides object operational authority and read authority.
<b>*EXCLUDE</b>	Exclude authority prevents the user from accessing the object.
<b>name</b>	Specify the name of an authorization list to be used for authority to the object. Users included in the authorization list are granted authority to the object as specified in the list. The authorization list must exist when the object is created.

---

## Examples

### Example 1:

CRTDEVGLP DEVD (GPL01)

This command creates a Gumbo logical printer with named GLP01. The CL command executed by the print driver program is contained in member GLP01 in the source physical file QUSRSYS/GLP01. The device is automatically varied on at IPL.

---

## Create Spool Save File (CRTSPLSAVF)

Where allowed to run: All environments (\*ALL)

Threadsafe: No

The Create Spool Save File (CRTSPLSAVF) command creates a save file containing a spooled file and all its related resources. The save file is suitable for emailing with a problem report.

---

### Parameters

Keyword	Description	Choices	Notes
<b>FILE</b>	Spooled file name	<i>Name</i>	Required, Positional 1
<b>SAVF</b>	Save file	<i>Qualified object name</i>	Required, Positional 2
	Qualifier 1: Save file	<i>Name</i>	
	Qualifier 2: Library	<i>Name</i> , * <b>CURLIB</b>	
<b>JOB</b>	Job name	Single values: * Other values: <i>Qualified job name</i>	Optional
	Qualifier 1: Job name	<i>Name</i>	
	Qualifier 2: User	<i>Name</i>	
	Qualifier 3: Number	000000-999999	
<b>SPLNBR</b>	Spooled file number	1-999999, *ONLY, * <b>LAST</b>	Optional
<b>SAVRSC</b>	Save resources	* <b>YES</b> , *NO, Y, N	Optional
<b>MSG</b>	Message	<i>Character value</i> , * <b>NONE</b>	Optional

---

### Spooled file name (FILE)

Specifies the name of the spooled file to process. CHAR(10)

This is a required parameter.

***name*** Specify the name of the spooled file.

---

### Save file (SAVF)

Specifies the name of the save file that is used to contain spooled file data. The saved file must not exist and will be created by the command.

This is a required parameter.

#### Qualifier 1: Save file

***name*** Specify the save file name.

#### Qualifier 2: Library

\***CURLIB** Use the current library for the job. If no library is specified as the current library for the job, QGPL is used.

***name*** Specify the name of the library.

---

### Job name (JOB)

Specifies the job that contains the spooled file.

#### Single values

**\*** The job that issued the command.

#### Qualifier 1: Job name

***name*** Specify the name of the job. CHAR(10)

## Qualifier 2: User

**name** Specify the name that identifies the user profile under which the job is run. CHAR(10)

## Qualifier 3: Number

**00000-99999** Specify the system assigned job number. CHAR(6)

---

## Spooled file number (SPLNBR)

Specifies the number of the spooled file. INT(4)

**\*LAST** The highest numbered spooled file with the specified file name is used.  
**\*ONLY** The number of the only spooled file with the specified file name is used.  
**1-99999** Specify the number of the spooled file.

---

## Save resources (SAVRSC)

Specifies if external resource such as overlays and page segments are included in the save file.

**\*YES** Resources are saved.  
**\*NO** Resources are not saved.

---

## Message (MSG)

Specifies a short message to include in the save file.

**\*NONE** No message is included.  
**character-value** Specify a short message to include in the save file.

---

## Examples

### Example 1:

```
CRTSPLSAVF FILE(QSYSPRT) SAVF(QGPL/PRBRPT)
```

This command creates save file PRBRPT in library QGPL. The last spooled file named QSYSPRT is saved along with its resources. The current job is searched to locate the file.

### Example 2:

```
CRTSPLSAVF FILE(QPQUPRFIL) SAVF(NEWPRB) SPLNBR(3)
```

The file named QPQUPRFIL, which is spooled file number 3 in the job executing this command, is saved to save file NEWPRB. The save file is placed in job's \*CURLIB.

---

## Error messages

### \*ESCAPE messages

**SPLE101** Unable to create spool save file for job //.

---

## Delete Device Gumbo Printer (DLTDEVGLP)

**Where allowed to run:** All environments (\*ALL)

**Threadsafe:** No

The Delete Device Gumbo Printer (DLTDEVGLP) command deletes a device description for a Gumbo logical printer.

**Note:** If a writer is active it is ended. If the device is varied on, it is varied off.

---

### Parameters

Keyword	Description	Choices	Notes
<b>DEV</b>	Device description	<i>Name</i>	Required, Positional 1

---

### Device description (DEV)

Specifies the name of the device description.

This is a required parameter.

***name***                      Specify the name of the device.

---

### Examples

#### Example 1:

```
DLTDEVGLP  DEV (GPL01)
```

This command deletes a Gumbo logical printer with named GPL01.

---

## Dump Page Index Positions (DMPPIP)

Where allowed to run: All environments (\*ALL)

Threadsafe: No

The Dump Page Index Positions (DMPPIP) command prints the line and position values, for data found in the spooled file, as calculated by the software. These are used to specify data selection criteria for the spooled file.

---

### Parameters

Keyword	Description	Choices	Notes
<b>FILE</b>	Spooled file name	<i>Name</i> , *LASTCRT	Required, Positional 1
<b>JOB</b>	Job name	Single values: * Other values: <i>Qualified job name</i>	Optional, Positional 2
	Qualifier 1: Job name	<i>Name</i>	
	Qualifier 2: User	<i>Name</i>	
	Qualifier 3: Number	000000-999999	
<b>SPLNBR</b>	Spooled file number	1-999999, *ONLY, * <b>LAST</b>	Optional, Positional 3
<b>PAGERANGE</b>	Page range to print	<i>Element list</i>	Optional, Positional 4
	Element 1: Starting page	<i>Integer</i> , <b>1</b> , *ENDPAGE	
	Element 2: Ending page	<i>Integer</i> , * <b>END</b>	

---

### Spooled file name (FILE)

Specifies the name of the spooled file to process. CHAR(10)

This is a required parameter.

**\*LASTCRT** The last spooled file created by the current job or thread is identified using the QSPRILSP API and processed. This is useful for jobs that create spooled files under other user profiles, which consequently end up in the user's QPRTJOB. When \*LASTCRT is specified, the JOB() and SPLNBR() parameters are ignored.

*name* Specify the name of the spooled file.

---

### Job name (JOB)

Specifies the job that contains the spooled file.

#### Single values

**\*** The job that issued the command.

#### Qualifier 1: Job name

*name* Specify the name of the job. CHAR(10)

#### Qualifier 2: User

*name* Specify the name that identifies the user profile under which the job is run. CHAR(10)

#### Qualifier 3: Number

**000000-999999** Specify the system assigned job number. CHAR(6)

---

### Spooled file number (SPLNBR)

Specifies the number of the spooled file. INT(4)

**\*LAST** The highest numbered spooled file with the specified file name is used.

**\*ONLY** The number of the only spooled file with the specified file name is used.

**1-999999** Specify the number of the spooled file.

---

## Page range to print (PAGERANGE)

Specifies the starting and ending pages to process.

### Element 1: Starting page

<u>1</u>	Processing begins at page 1.
<b>*ENDPAGE</b>	The starting page to print is the ending page to print. Only the ending page is printed.
<i>integer</i>	Specify the starting page.

### Element 2: Ending page

<b>*END</b>	Processing continues until the end of file.
<i>integer</i>	Specify the ending page.

---

## Examples

### Example 1:

```
DMPPIP      FILE(QSYSPRT)
             JOB(033194/QPGMR/MONTHEND) SPLNBR(2)
```

This command dumps data position information for spooled file number 2, QSYSPRT, from job 033194/QPGMR/MONTHEND.

### Example 2:

```
DMPPIP      FILE(QSYSPRT) PAGERANGE(3 4)
```

This command dumps data position information for the last spooled file with name QSYSPRT from the job running the command. Only the data for pages 3 and 4 is dumped.

---

## Error messages

### \*ESCAPE messages

<b>SIX0001</b>	Unable to dump page index positions for file .
----------------	--



## Display Mail Log (DSPMAILLOG)

Where allowed to run: All environments (\*ALL)

Threadsafe: No

The Display Mail Log (DSPMAILLOG) command shows the system mail log (IBM i journal QZMF). The mail log contains information about the processing of mail.

**Note:** Mail journaling must be turned on. To turn on mail journaling, specify JOURNAL(\*YES) on the CHGSMTPA command. Only journal receivers in the current chain are searched.

### Parameters

Keyword	Description	Choices	Notes
PERIOD	Time period	<i>Element list</i>	Optional, Positional 1
	Element 1: Starting time and date	<i>Element list</i>	
	Element 1: Starting time	<i>Time, *AVAIL</i>	
	Element 2: Starting date	<i>Date, *CURRENT, *BEGIN</i>	
	Element 2: Ending time and date	<i>Element list</i>	
	Element 1: Ending time	<i>Time, *AVAIL</i>	
OUTPUT	Element 2: Ending date	<i>Date, *CURRENT, *END</i>	Optional, Positional 2
	Output	<i>*, *PRINT</i>	
		<i>_, *PRINT</i>	

### Time period (PERIOD)

Specifies the period of time for which the logged message data is shown. This parameter contains two lists of two elements each.

#### Element 1: Starting time and date

**Element 1: Starting time** One of the following specifies the starting time from which entries are shown. Entries logged before this time on the **Starting date** are not shown.

**\*AVAIL**  
**time**

All data that is available for the specified date is shown.

Specify the start time from which data for the specified date is shown. The time is specified in 24-hour format and can be specified with or without a time separator:

- Without a time separator, specify a string of 4 or 6 digits (hhmm or hhmmss) where hh = hours, mm = minutes, and ss = seconds.
- With a time separator, specify a string of 5 or 8 digits where the time separator specified for your job is used to separate the hours, minutes, and seconds. If you enter this command from the command line, the string must be enclosed in apostrophes. If a time separator other than the separator specified for your job is used, this command will fail.

**Element 2: Starting date** One of the following specifies the starting date from which entries are shown. Entries logged before this date are not shown.

**\*CURRENT**  
**\*BEGIN**  
**date**

The current date is used.

The data from the beginning of the log is shown.

Specify the start date from which data is shown. The date must be specified in the job date format.

#### Element 2: Ending time and date

**Element 1: Ending time** One of the following specifies the ending time to which entries are shown. Entries logged after this time on the **Ending date** are not shown.

**\*AVAIL**  
**time**

All data that is available for the specified date is shown.

Specify the end time to which data for the specified date is shown. The time is specified in 24-hour format and can be specified with or without a time separator:

- Without a time separator, specify a string of 4 or 6 digits (hhmm or hhmmss) where hh = hours, mm = minutes, and ss = seconds.
- With a time separator, specify a string of 5 or 8 digits where the time separator specified for your job is used to separate the hours, minutes, and

seconds. If you enter this command from the command line, the string must be enclosed in apostrophes. If a time separator other than the separator specified for your job is used, this command will fail.

**Element 2: Ending date** One of the following specifies the ending date to which entries are shown. Entries logged after this date are not shown.

<b>*CURRENT</b>	The current date is used.
<b>*END</b>	The data to the end of the log is shown.
<b>date</b>	Specify the end date to which data is shown. The date must be specified in the job date format.

---

## Output (OUTPUT)

Specifies where the output from the command is sent. CHAR(10)

<b>_</b>	The output is displayed (if requested by an interactive job) or printed with the job's spooled output (if requested by a batch job).
<b>*PRINT</b>	The output is printed with the job's spooled output.

---

## Examples

### Example 1:

```
DSPMAILLOG
```

The mail log entries for today are displayed on the screen.

### Example 2:

```
DSPMAILLOG PERIOD ( (*AVAIL *BEGIN) (*AVAIL *END) )  
                OUTPUT (*PRINT)
```

All available mail log entries in the current journal receiver chain are printed.

---

## Error messages

### \*ESCAPE messages

<b>MSU1074</b>	Error encountered processing request.
<b>MSU1076</b>	No data for requested time range.
<b>MSU5151</b>	Mail journaling has not been turned on.

## Display Page Data (DSPPAGDTA)

Where allowed to run: All environments (\*ALL)

Threadsafe: No

The Display Page Data (DSPPAGDTA) command shows the contents of a spooled file's pages at specified locations. The contents can be shown, printed, or directed to database output file (OUTFILE).

### Parameters

Keyword	Description	Choices	Notes
<b>FILE</b>	Spooled file name	<i>Name</i> , *LASTCRT	Required, Positional 1
<b>PAGDTA</b>	Page data	Values (up to 12 repetitions): <i>Element list</i>	Required, Positional 2
	Element 1: Line	1-255, *STRPAGGRP, *DOCIDXTAG, *DOCIXPAG, *DOCIDXGRP, *STRPAGGRPP, *DOCIDXTAGP, *DOCIDXGRPP	
	Element 2: Position	1-378, 0	
	Element 3: Length	1-255, 0	
<b>JOB</b>	Job name	Single values: * Other values: <i>Qualified job name</i>	Optional, Positional 3
	Qualifier 1: Job name	<i>Name</i>	
	Qualifier 2: User	<i>Name</i>	
	Qualifier 3: Number	000000-999999	
<b>SPLNBR</b>	Spooled file number	1-999999, *ONLY, * <b>LAST</b>	Optional, Positional 4
<b>OUTPUT</b>	Output	*, *PRINT, *OUTFILE	Optional
<b>OUTFILE</b>	File to receive output	<i>Qualified object name</i>	Optional
	Qualifier 1: File to receive output	<i>Name</i>	
	Qualifier 2: Library	<i>Name</i> , *LIBL, *CURLIB	
<b>OUTMBR</b>	Output member options	<i>Element list</i>	Optional
	Element 1: Member to receive output	<i>Name</i> , * <b>FIRST</b>	
	Element 2: Replace or add records	* <b>REPLACE</b> , *ADD	

### Spooled file name (FILE)

Specifies the name of the spooled file to process. CHAR(10)

This is a required parameter.

- \*LASTCRT** The last spooled file created by the current job or thread is identified using the QSPRILSP API and processed. This is useful for jobs that create spooled files under other user profiles, which consequently end up in the user's QPRTJOB. When \*LASTCRT is specified, the JOB() and SPLNBR() parameters are ignored.
- name*** Specify the name of the spooled file.

### Page data (PAGDTA)

Specifies the location (line, position and length), on the page of the spooled file, from which data is retrieved. INT(2), INT(2), INT(2)

This is a required parameter.

#### Element 1: Line

- \*STRPAGGRP** Data specified on the DDS STRPAGGRP() keyword is retrieved. These keywords inherit the page number of the next page to occur in the spooled file.  
This value is only valid with \*AFPDS spooled files. Position and length are ignored as data does not appear on the printed page and the length is derived from the value stored.
- \*DOCIDXTAG** Data specified on the DDS DOCIDXTAG() keyword is retrieved. Tags specified at both the "page" level and "group" level are processed. "Group" level tags inherit the page number of the next page to occur in the spooled file.

This value is only valid with \*AFPDS spooled files. Position and length are ignored as data does not appear on the printed page and the length is derived from the value stored.

**\*DOCIXPAG** Data specified on the DDS DOCIDXTAG() keyword is retrieved. Only tags specified at the "page" level are processed.

This value is only valid with \*AFPDS spooled files. Position and length are ignored as data does not appear on the printed page and the length is derived from the value stored.

**\*DOCIXGRP** Data specified on the DDS DOCIDXTAG() keyword is retrieved. Only tags specified at the "group" level are processed. These tags inherit the page number of the next page to occur in the spooled file.

This value is only valid with \*AFPDS spooled files. Position and length are ignored as data does not appear on the printed page and the length is derived from the value stored.

**\*STRPAGGRP** Data specified on the DDS STRPAGGRP() keyword is retrieved. These keywords inherit the page number of the next page to occur in the spooled file and are propagated to subsequent pages in the page group. Propagation processing gives the appearance that the keyword was specified directly on each subsequent page in the group.

This value is only valid with \*AFPDS spooled files. Position and length are ignored as data does not appear on the printed page and the length is derived from the value stored.

**\*DOCIXTAGP** Data specified on the DDS DOCIDXTAG() keyword is retrieved. Tags specified at both the "page" level and "group" level are processed. "Group" level tags inherit the page number of the next page to occur in the spooled file and are propagated to subsequent pages in the page group. Propagation processing gives the appearance that the "group" level tag was specified directly on each subsequent page in the group.

This value is only valid with \*AFPDS spooled files. Position and length are ignored as data does not appear on the printed page and the length is derived from the value stored.

**\*DOCIXGRP** Data specified on the DDS DOCIDXTAG() keyword is retrieved. Only tags specified at the "group" level are processed. These tags inherit the page number of the next page to occur in the spooled file and are propagated to subsequent pages in the page group. Propagation processing gives the appearance that the "group" level tag was specified directly on each subsequent page in the group.

This value is only valid with \*AFPDS spooled files. Position and length are ignored as data does not appear on the printed page and the length is derived from the value stored.

**1-255** Specify the line number where the data is located on the page.

## Element 2: Position

**1-378** Specify the position where the data is located in the line. Valid values range from 1 through 378. The value specified plus the data length should be less than the number of print positions in the spooled file.

## Element 3: Length

**1-255** Specify the length of the data. The value specified plus the start position should be less than the number of print positions in the spooled file.

---

## Job name (JOB)

Specifies the job that contains the spooled file.

### Single values

**\*** The job that issued the command.

### Qualifier 1: Job name

**name** Specify the name of the job. CHAR(10)

### Qualifier 2: User

**name** Specify the name that identifies the user profile under which the job is run. CHAR(10)

### Qualifier 3: Number

**000000-999999** Specify the system assigned job number. CHAR(6)

---

## Spooled file number (SPLNBR)

Specifies the number of the spooled file. INT(4)

<b>*LAST</b>	The highest numbered spooled file with the specified file name is used.
<b>*ONLY</b>	The number of the only spooled file with the specified file name is used.
<b>1-999999</b>	Specify the number of the spooled file.

---

## Output (OUTPUT)

Specifies where the output from the command is sent. CHAR(10)

<b>*</b>	The output is displayed (if requested by an interactive job) or printed with the job's spooled output (if requested by a batch job).
<b>*PRINT</b>	The output is printed with the job's spooled output.
<b>*OUTFILE</b>	The output is directed to the database file specified on the <b>File to receive output</b> prompt (OUTFILE parameter).

---

## File to receive output (OUTFILE)

Specifies the name and library of the database file to which the output of the command is directed. If the file does not exist, the command creates one in the specified library. CHAR(10) CHAR(10)

### Qualifier 1: File to receive output

**name** Specify the name of the file to which the output of the command is directed.

### Qualifier 2: Library

<b>*LIBL</b>	All libraries in the thread's library list are searched.
<b>*CURLIB</b>	Use the current library for the job. If no library is specified as the current library for the job, QGPL is used.
<b>name</b>	Specify the name of the library.

Data is output in the PDPAGDRF record format which is documented in the appendix.

---

## Output member options (OUTMBR)

Specifies the name of the database file member that receives the output of the command. CHAR(10) CHAR(10)

### Element 1: Member to receive output

<b>*FIRST</b>	The first member in the file receives the output. If it does not exist, the system creates a member with the name of the file specified in the <b>File to receive output</b> prompt (OUTFILE parameter). If the member already exists, you have the option to add new records to the end of the existing member or clear the member and then add the new records.
<b>name</b>	Specify the name of the member that receives the output. If it does not exist, the system creates it.

### Element 2: Replace or add records

<b>*REPLACE</b>	The system clears the existing member and adds the new records.
<b>*ADD</b>	The system adds the new records to the end of the existing records.

---

## Examples

### Example 1:

```
DSPPAGDTA FILE(QSYSPRT)
          PAGDTA((3 4 10) (*STRPAGGRP))
          JOB(033194/QPGMR/MONTHEND) SPLNBR(2)
```

This command displays data from line 3, position 4 for a length of 10 from each page in the spooled file as well as the page group names added using the STRPAGGRP() DDS keyword. The spooled file processed is file number 2, QSYSPRT, from job 033194/QPGMR/MONTHEND.

**Example 2:**

```
DSPPAGDTA FILE (INVOICE) PAGDTA ( (*DOCIDXTAG) )
          OUTPUT (*OUTFILE)
          OUTFILE (HISTORY/INVSPLF)
          OUTMBR (*FIRST *ADD)
```

This command retrieves data stored in DOCIDXTAG() DDS keywords for all pages of the spooled file INVOICE found in the current job. The data is added to the first member of the file INVSPLF found in library HISTORY.

---

**Error messages****Parameter dependencies**

**GCM7014**       OUTFILE parameter required with OUTPUT(\*OUTFILE).  
**GCM7015**       OUTFILE parameter can only be specified with OUTPUT(\*OUTFILE).  
**GCM7016**       OUTMBR parameter can only be specified with OUTPUT(\*OUTFILE).

**\*ESCAPE messages**

**SIX0045**       Unable to display page data for file .

---

## Extract AFP Resources (EXTAFPRSC)

Where allowed to run: All environments (\*ALL)

Threadsafe: No

The Extract AFP Resources (EXTAFPRSC) command creates a file containing a member for each AFP resource found in an \*AFPDS spooled file's external resource group. The file is suitable for creating local copies of AFP resources using the IBM i commands.

---

### Parameters

Keyword	Description	Choices	Notes
<b>FILE</b>	Spooled file name	<i>Name</i>	Required, Positional 1
<b>OUTFILE</b>	File to receive output	<i>Qualified object name</i>	Required, Positional 2
	Qualifier 1: File to receive output	<i>Name</i>	
	Qualifier 2: Library	<i>Name</i> , * <b>CURLIB</b>	
<b>JOB</b>	Job name	Single values: * Other values: <i>Qualified job name</i>	Optional
	Qualifier 1: Job name	<i>Name</i>	
	Qualifier 2: User	<i>Name</i>	
	Qualifier 3: Number	000000-999999	
<b>SPLNBR</b>	Spooled file number	1-999999, *ONLY, * <b>LAST</b>	Optional

---

### Spooled file name (FILE)

Specifies the name of the spooled file to process. CHAR(10)

This is a required parameter.

***name*** Specify the name of the spooled file.

---

### File to receive output (OUTFILE)

Specifies the name and library of the database file to which the output of the command is directed. If the file does not exist, the command creates one in the specified library. CHAR(10) CHAR(10)

This is a required parameter.

#### Qualifier 1: File to receive output

***name*** Specify the name of the file to which the output of the command is directed.

#### Qualifier 2: Library

\***LIBL** All libraries in the thread's library list are searched.

\***CURLIB** Use the current library for the job. If no library is specified as the current library for the job, QGPL is used.

***name*** Specify the name of the library.

---

### Job name (JOB)

Specifies the job that contains the spooled file.

#### Single values

\* The job that issued the command.

#### Qualifier 1: Job name

***name*** Specify the name of the job. CHAR(10)

## Qualifier 2: User

**name** Specify the name that identifies the user profile under which the job is run. CHAR(10)

## Qualifier 3: Number

**000000-999999** Specify the system assigned job number. CHAR(6)

---

## Spooled file number (SPLNBR)

Specifies the number of the spooled file. INT(4)

**\*LAST** The highest numbered spooled file with the specified file name is used.  
**\*ONLY** The number of the only spooled file with the specified file name is used.  
**1-999999** Specify the number of the spooled file.

---

## Examples

### Example 1:

```
EXTAFPRSC FILE(QSYSPRT) OUTFILE(QGPL/AFPRSC)
```

This command extracts AFP resources to file AFPRSC in library QGPL. The last spooled file named QSYSPRT is processed. The current job is searched to locate the file.

### Example 2:

```
EXTAFPRSC FILE(INVOICES) OUTFILE(QGPL/NEWRSC) SPLNBR(3)
```

The file named INVOICES which is spooled file number 3 in the job executing this command is processed and resources placed in file NEWRSC in library QGPL.

---

## Error messages

### \*ESCAPE messages

**AFP1012** Resource extraction failed.



---

## Restart/Purge Local Mail (INZLOCAL)

Where allowed to run: All environments (\*ALL)

Threadsafe: No

The Restart/Purge Local Mail (INZLOCAL) command ends and restarts IBM i mail components. This may be required to clear problems or to make configuration changes immediately effective.

---

### Parameters

Keyword	Description	Choices	Notes
<b>SMTP</b>	Restart SMTP server	<u>*YES</u> , *NO, Y, N	Optional, Positional 1
<b>SMTTPURGE</b>	Clear SMTP during restart	<u>*NO</u> , *YES, Y, N	Optional, Positional 2
<b>MSF</b>	Restart MSF server	<u>*YES</u> , *NO, Y, N	Optional, Positional 3
<b>MSFPURGE</b>	Clear MSF during restart	<u>*NO</u> , *YES, Y, N	Optional, Positional 4

---

### Restart SMTP server (SMTP)

Specifies the whether the SMTP server is restarted.

- \*YES            The SMTP server is first ended then started.
- \*NO            The command does not restart the SMTP server.

---

### Clear SMTP during restart (SMTTPURGE)

Specifies the whether the SMTP server is purged during the restart.

**Note:** Clear means that all IBM i SMTP email will be deleted. If you are not sure, select \*NO.

- \*NO            Existing messages are not cleared.
- \*YES           Existing messages are cleared.

---

### Restart MSF server (MSF)

Specifies the whether the MSF server is restarted.

- \*YES            The MSF server is first ended then started.
- \*NO            The command does not restart the MSF server.

---

### Clear MSF during restart (MSFPURGE)

Specifies the whether the MSF server is cleared during the restart.

**Note:** Clear means that mail server framework distributions (emails) will be deleted from this system. If you are not sure, select \*NO.

- \*NO            The MSF is not cleared.
- \*YES           The MSF is cleared.

---

### Examples

#### Example 1:

```
INZLOCAL
```

This command restarts the SMTP server and Mail Server Framework jobs.

**Example 2:**

```
INZLOCAL      SMTPPURGE (*YES) MSFPURGE (*YES)
```

This command restarts the SMTP server and Mail Server Framework jobs after purging all data they contain.

---

**Error messages****Parameter dependencies**

<b>MSU7012</b>	SMTP cannot be cleared unless it is also restarted.
<b>MSU7013</b>	MSF cannot be cleared unless it is also restarted.

---

## Ping SMTP Mail Server (PINGMAIL)

**Where allowed to run:** All environments (\*ALL)

**Threadsafe:** No

The Ping SMTP Mail Server (PINGMAIL) command establishes an SMTP connection with a remote system to insure it will process email from the local System i.

The detailed send and receive data from the connection is recorded in the joblog and can be view using the Display Job Log (DSPJOBLOG) command.

---

### Parameters

Keyword	Description	Choices	Notes
<b>RMTSYS</b>	Remote system	Character value, *INTNETADR	Required, Positional 1
<b>SMTPNAME</b>	To SMTP name (email address)	Character value, *NONE	Optional
<b>SMTPNAME2</b>	From SMTP name (email address)	Character value, *SMTPNAME	Optional
<b>AUTHUSRNAM</b>	Authentication username	Character value, *NONE	Optional
<b>AUTHPWD</b>	Authentication password	Character value	Optional
<b>PORT</b>	Port	0-65534, 25	Optional
<b>INTNETADR</b>	Remote internet address	Character value	Optional

---

### Remote system (RMTSYS)

Specifies the remote system name of the host with which the Ping SMTP Mail Server operation takes place. To be successful, the name must be valid, and the remote system must be able to communicate with the local system.

This is a required parameter.

**\*INTNETADR** The INTNETADR parameter is used.  
**character-value** Specify the remote system name to use.

---

### To SMTP name (email address) (SMTPNAME)

Specifies an email address to verify with the remote host. A short email message is sent to the address. The message is inserted directly into the mail server under test, bypassing all of IBM i's mail machinery. This makes it is easier to determine if a mail delivery problem is most likely caused by the mail server or by IBM i's configuration.

**\*NONE** An email address is not specified.  
**character-value** Specify the email address to use.

---

### From SMTP name (email address) (SMTPNAME2)

Specifies the from email address included in the test message.

**\*SMTPNAME** The To SMTP name (email address) is used as the From SMTP name (email address).  
**character-value** Specify the email address to use.

---

### Authentication username (AUTHUSRNAM)

Specifies the user name used to authenticate with the remote system.

**\*NONE** Authentication is not performed.  
**character-value** Specify the user name to send to the remote system for authentication.

---

### Authentication password (AUTHPWD)

Specifies the password used to authenticate with the remote system.

**character-value** Specify the password to send to the remote system for authentication.

---

## Port (PORT)

Specifies the port on which the remote system is listening.

**25** Use the well-known port 25 for SMTP.

**integer** Specify any port in the range of 1 to 65534 on which the remote system is listening for SMTP connections.

---

## Remote internet address (INTNETADR)

Specifies the remote internet address. The internet address is specified in the form **nnn.nnn.nnn.nnn**, where **nnn** is a decimal number ranging from 0 through 255. An internet address is not valid if it has a value of all binary ones or all binary zeros for the network identifier (ID) portion or the host ID portion of the address. If the internet address is entered from a command line, enclose the address in apostrophes.

**character-value** Specify the internet address of the remote system. If the internet address is entered from a command line, enclose the address in apostrophes.

---

## Examples

### Example 1:

```
PINGMAIL RMTSYS (system2.widget.com)
```

This command tests system2 in the widget.com domain to insure that it will process email.

### Example 2:

```
PINGMAIL RMTSYS (*INTNETADR INTNETADR ('168.243.199.2'))
```

This command tests the system at IP address 168.243.199.2 to insure that it will process email.

---

## Error messages

### Parameter dependencies

**MSU7009** When \*INTNETADR is specified Remote internet address must be specified.

**MSU7010** RMTSYS(\*INTNETADR) required when INTNETADR is specified.

### \*ESCAPE messages

**MSU1068** Error encountered verifying mail server.

**MSU1077** Connection to mail server at address complete, but errors occurred.

---

## Retrieve Gumbo PTF (RTVGSIPTF)

**Where allowed to run:** All environments (\*ALL)

**Threadsafe:** No

The Retrieve Gumbo PTF (RTVGSIPTF) command checks a remote system for new product PTFs, and, if available, downloads and installs them.

The command assumes that the System i has connectivity to the PTF server. Unless you are running your own internal server hosting our PTFs, this means that the System i has access to the internet and that FTP is not blocked by a firewall.

The command first checks the availability of new PTFs by retrieving a product and release specific file (Ex. q2m70LastPtf.txt) from the remote system and comparing its contents to the last PTF applied locally. If newer PTFs are available, a product and release specific PTF save file (Ex. q2m70all.svf) is downloaded, and the PTFs it contains are loaded and applied.

**Note:** **GUMBO** only delivers immediate PTFs. Immediate PTFs do not require an IPL and an IPL is never performed by the command.

---

### Parameters

Keyword	Description	Choices	Notes
<b>LICPGM</b>	Product	Character value, <b>*THIS</b> , 2A55DCR, 2A55DMP, 2A55RDA, 2A55RM1, 2A55SAM, 2A55SM1, 2A55SM2, 2A55XL1	Optional, Positional 1
<b>RLS</b>	Release	Character value, <b>*THIS</b>	Optional, Positional 2
<b>CHECK</b>	Check	<b>*YES</b> , *NO, *ONLY	Optional
<b>RMTSYS</b>	Remote system	Character value, <b>*GUMBOFTP</b>	Optional

---

### Product (LICPGM)

Specifies the product for which PTFs are retrieved. All **GUMBO** products take the form 2A55tla where "tla" identifies the product. Run DSPSPWRSC to determine which **GUMBO** products are installed. CHAR(7)

<b>*THIS</b>	Use the product (2A55SM1) containing this copy of the Retrieve Gumbo PTF (RTVGSIPTF) command.
<b>2A55DCR</b>	Dicer
<b>2A55DMP</b>	Dumpster
<b>2A55RDA</b>	Report Designer
<b>2A55RM1</b>	Report Manager
<b>2A55SAM</b>	Spool-a-Matic
<b>2A55SM1</b>	SpoolMail
<b>2A55SM2</b>	Gumbo Mail
<b>2A55XL1</b>	Excel-erator
<b>character-value</b>	Specifies the 7-character identifier of the product for which PTFs are retrieved.

---

### Release (RLS)

Specifies the release for which PTFs are retrieved. Run DSPSPWRSC to determine which **GUMBO** products are installed. CHAR(6)

<b>*THIS</b>	Use the release of the product (V2R7M0) containing this copy of the Retrieve Gumbo PTF (RTVGSIPTF) command.
<b>character-value</b>	Specify the release level of the product in the format VxRyMz, where Vx is the version number, Ry is the release number, and Mz is the modification level.

---

### Check (CHECK)

Specifies if checking for newer PTFs is performed. CHAR(10)

<b>*YES</b>	Check for newer PTFs is performed before downloading. If newer PTFs are not available, processing stops.
<b>*NO</b>	No check for newer PTFs is performed before downloading.
<b>*ONLY</b>	Only a check for newer PTF availability is performed. Nothing is downloaded, regardless of the result.

---

## Remote system (RMTSYS)

Specifies the name of remote system which serves PTF save files for download. CHAR(255)

<b>*GUMBOFTP</b>	Use <b>GUMBO's</b> FTP server ftp.gumbo.com.
<b>character-value</b>	Specify the remote system name to use.

---

## Examples

### Example 1:

RTVGSIPTF

The **GUMBO** FTP server is check for new PTFs available for product 2A55SM1 release V2R7M0. If available, the PTFs are downloaded and installed.

### Example 2:

RTVGSIPTF PRODUCT(2A55SM1) RLS(V2R7M0) CHECK(\*ONLY)

The **GUMBO** FTP server is check for new PTFs available for product 2A55SM1 release V2R7M0. No other processing is performed.

---

## Error messages

### \*ESCAPE messages

<b>PID1007</b>	Retrieve PTF failed for product .
----------------	-----------------------------------

---

## Retrieve Page Data (RTVPAGDTA)

### Where allowed to run:

Batch program (\*BPGM)

Interactive program (\*IPGM)

Threadsafe: No

The Retrieve Page Data (RTVPAGDTA) command retrieves data from a specific location in a spooled file. The requested data is returned in a Control Language (CL) program variable.

---

## Parameters

Keyword	Description	Choices	Notes
<b>FILE</b>	Spooled file name	<i>Name</i> , *LASTCRT	Required, Positional 1
<b>RTNDATA</b>	CL var for data (1-255)	<i>Character value</i>	Required, Positional 2
<b>PAGDTA</b>	Page data	<i>Element list</i>	Required, Positional 3
	Element 1: Line	1-255, *STRPAGGRP, *DOCIDXTAG, *DOCIDXPAG, *DOCIDXGRP, *STRPAGGRPP, *DOCIDXTAGP, *DOCIDXGRPP	
	Element 2: Position	1-378, 0	
	Element 3: Length	1-255, 0	
<b>PAGE</b>	Page number	<i>Unsigned integer</i> , <u>1</u> , *LAST	Optional, Positional 4
<b>JOB</b>	Job name	Single values: <u>*</u> Other values: <i>Qualified job name</i>	Optional, Positional 5
	Qualifier 1: Job name	<i>Name</i>	
	Qualifier 2: User	<i>Name</i>	
	Qualifier 3: Number	000000-999999	
<b>SPLNBR</b>	Spooled file number	1-999999, *ONLY, * <u>LAST</u>	Optional, Positional 6

---

## Spooled file name (FILE)

Specifies the name of the spooled file to process. CHAR(10)

This is a required parameter.

- \*LASTCRT** The last spooled file created by the current job or thread is identified using the QSPRILSP API and processed. This is useful for jobs that create spooled files under other user profiles, which consequently end up in the user's QPRTJOB. When \*LASTCRT is specified, the JOB() and SPLNBR() parameters are ignored.
- name** Specify the name of the spooled file.

---

## CL var for data (1-255) (RTNDATA)

Specifies the CL variable which is to receive the data returned by the command. The variable can have a declared length between 1 and 255 and it must be as long as or longer than the requested data length. (CHAR).

This is a required parameter.

---

## Page data (PAGDTA)

Specifies the location (line, position and length), on the page of the spooled file, from which data is retrieved. INT(2), INT(2), INT(2)

This is a required parameter.

### Element 1: Line

- \*STRPAGGRP** Data specified on the DDS STRPAGGRP() keyword is retrieved. These keywords inherit the page number of the next page to occur in the spooled file.
- This value is only valid with \*AFPDS spooled files. Position and length are ignored as data does not appear on the

printed page and the length is derived from the value stored.

**\*DOCIDXTAG** Data specified on the DDS DOCIDXTAG() keyword is retrieved. Tags specified at both the "page" level and "group" level are processed. "Group" level tags inherit the page number of the next page to occur in the spooled file.

This value is only valid with \*AFPDS spooled files. Position and length are ignored as data does not appear on the printed page and the length is derived from the value stored.

**\*DOCIXPAG** Data specified on the DDS DOCIDXTAG() keyword is retrieved. Only tags specified at the "page" level are processed.

This value is only valid with \*AFPDS spooled files. Position and length are ignored as data does not appear on the printed page and the length is derived from the value stored.

**\*DOCIXGRP** Data specified on the DDS DOCIDXTAG() keyword is retrieved. Only tags specified at the "group" level are processed. These tags inherit the page number of the next page to occur in the spooled file.

This value is only valid with \*AFPDS spooled files. Position and length are ignored as data does not appear on the printed page and the length is derived from the value stored.

**\*STRPAGGRP** Data specified on the DDS STRPAGGRP() keyword is retrieved. These keywords inherit the page number of the next page to occur in the spooled file and are propagated to subsequent pages in the page group. Propagation processing gives the appearance that the keyword was specified directly on each subsequent page in the group.

This value is only valid with \*AFPDS spooled files. Position and length are ignored as data does not appear on the printed page and the length is derived from the value stored.

**\*DOCIDXTAGP** Data specified on the DDS DOCIDXTAG() keyword is retrieved. Tags specified at both the "page" level and "group" level are processed. "Group" level tags inherit the page number of the next page to occur in the spooled file and are propagated to subsequent pages in the page group. Propagation processing gives the appearance that the "group" level tag was specified directly on each subsequent page in the group.

This value is only valid with \*AFPDS spooled files. Position and length are ignored as data does not appear on the printed page and the length is derived from the value stored.

**\*DOCIXGRP** Data specified on the DDS DOCIDXTAG() keyword is retrieved. Only tags specified at the "group" level are processed. These tags inherit the page number of the next page to occur in the spooled file and are propagated to subsequent pages in the page group. Propagation processing gives the appearance that the "group" level tag was specified directly on each subsequent page in the group.

This value is only valid with \*AFPDS spooled files. Position and length are ignored as data does not appear on the printed page and the length is derived from the value stored.

**1-255** Specify the line number where the data is located on the page.

## Element 2: Position

**1-378** Specify the position where the data is located in the line. Valid values range from 1 through 378. The value specified plus the data length should be less than the number of print positions in the spooled file.

## Element 3: Length

**1-255** Specify the length of the data. The value specified plus the start position should be less than the number of print positions in the spooled file.

---

## Page number (PAGE)

Specifies the page number from which data is retrieved. INT(4)

**1** Data is retrieved from the first page of the spooled file.

**\*LAST** Data is retrieved from the last page of the spooled file.

**integer** Specifies the page from which data is retrieved.

---

## Job name (JOB)

Specifies the job that contains the spooled file.



## Single values

**\***                    The job that issued the command.

### Qualifier 1: Job name

**name**                Specify the name of the job. CHAR(10)

### Qualifier 2: User

**name**                Specify the name that identifies the user profile under which the job is run. CHAR(10)

### Qualifier 3: Number

**000000-999999**    Specify the system assigned job number. CHAR(6)

---

## Spooled file number (SPLNBR)

Specifies the number of the spooled file. INT(4)

**\*LAST**                The highest numbered spooled file with the specified file name is used.  
**\*ONLY**                The number of the only spooled file with the specified file name is used.  
**1-999999**             Specify the number of the spooled file.

---

## Examples

### Example 1:

```
RTVPAGDTA    FILE (QSYSPRT)
               RTNDATA (&CUSTNO) PAGDTA (3 4 10)
               JOB (033194/QPGMR/MONTHEND) SPLNBR (2)
```

This command retrieve data from line 3, position 4 for a length of 10 from the first page in the spooled file and places the data in the variable &CUSTNO. The spooled file processed is file number 2, QSYSPRT, from job 033194/QPGMR/MONTHEND.

---

## Error messages

### \*ESCAPE messages

**SIX0049**             Unable to retrieve page data for file .

## Send Spool Mail (SNDSPLMAIL)

Where allowed to run: All environments (\*ALL)

Threading: No

The Send Spool Mail (SNDSPLMAIL) command converts an IBM i spooled file and sends it as email to a recipient.

### Parameters

Keyword	Description	Choices	Notes
<b>FILE</b>	Spooled file name	<i>Name</i> , *LASTCRT	Required, Positional 1
<b>JOB</b>	Job name	Single values: * Other values: <i>Qualified job name</i>	Optional
	Qualifier 1: Job name	<i>Name</i>	
	Qualifier 2: User	<i>Name</i>	
	Qualifier 3: Number	000000-999999	
<b>SPLNBR</b>	Spooled file number	1-999999, *ONLY, * <b>LAST</b>	Optional
<b>TRANSFORM</b>	Transform to perform	<i>Character value</i> , * <b>TEXT</b> , *PDFLETTER, *PDFLEGAL, *PDFSTATEMENT, *PDFEXECUTIVE, *PDFLEDGER, *PDFA3, *PDFA4, *PDFA5, *PDFB4, *PDFB5, *PDFLETTERLEGAL, *PDFLEGALLETTER, *PDFALLETTER, *PDFALEGAL, *PDFASTATEMENT, *PDFAEEXECUTIVE, *PDFALEDGER, *PDFAA3, *PDFAA4, *PDFAA5, *PDFAB4, *PDFAB5, *PDFALTRLGL, *PDFALGLLTR, *PDFPAGESIZE, *RTFLETTER, *RTFLEGAL, *RTFSTATEMENT, *RTFEXECUTIVE, *RTFLEDGER, *RTFA3, *RTFA4, *RTFA5, *RTFB4, *RTFB5, *HTMLCSS, *HTMLBASIC, *POSTSCRIPT, *AFPPRINTFILE, *AFPPRINTFILE2, *TIFFLETTER, *TIFFLEGAL, *TIFFEXECUTIVE, *TIFFLEDGER, *TIFFA3, *TIFFA4, *TIFFA5, *TIFFB4, *TIFFB5, *TIFFCONT80, *TIFFCONT132, *TIFF, *TIFFG4, *TIFFPB, *FFT BASIC, *TXTTFF, *TXTTRIM, *TXTTRIMFL, *WSCST, *NONE, *NONEPDF, *WSCSTLETTER, *WSCSTLEGAL, *WSCSTEXECUTIVE, *WSCSTA4, *WSCSTA5, *WSCSTB5, *WSCSTCONT80, *WSCSTCONT132, *CRLF, *PDF, *PDFLETTERBASIC, *PDFLEGALBASIC, *PDFA4BASIC, *PDF811, *PDF814, *PDF811814, *PDF814811, *RTF811, *RTF814	Optional
<b>TOSMTPNAME</b>	To (recipient)	Single values: * <b>CURRENT</b> , *MAILTAG, *PAGDTA, *SPLFOWN, *SPLFCRT, *USRDFNDDTA, *USRDFNTXT, *USRDTAUP, *NONE, *STRPAGGRP Other values (up to 300 repetitions): <i>Element list</i>	Optional
	Element 1:	<i>Character value</i> , *USRID	
<b>WSCST</b>	Workstation customizing object	Single values: * <b>NONE</b> Other values: <i>Qualified object name</i>	Optional
	Qualifier 1: Workstation customizing object	<i>Name</i>	
	Qualifier 2: Library	<i>Name</i> , * <b>LIBL</b> , *CURLIB	
<b>TOUSRID</b>	To (distribution list)	Single values: * <b>NONE</b> , *GATEWAY, *CURRENT, *SPLFOWN, *SPLFCRT Other values: <i>Element list</i>	Optional
	Element 1: User ID	<i>Character value</i>	
	Element 2: Address	<i>Character value</i>	
<b>SEND</b>	Send as	* <b>ATTACH</b> , *NOTE, *TEXTHTML, *TEXTPLAIN	Optional
<b>SUBJECT</b>	Subject	<i>Character value</i> , * <b>DEFAULT</b> , *NONE, *ACGCDE, *CRTSYS, *CRTUSR, *FILE, *FILE8, *FORMTYPE, *JOBNAM, *JOBNAM8, *JOBNBR, *JOBUSR, *JOBUSR8, *OUTQ, *PAGDTA, *PAGECOUNT, *PAGECNTZ, *PGM, *PGM8, *PRTTXX, *SPLCDAT, *SPLCTIM, *SPLCCYY, *SPLCY, *SPLCMM, *SPLCDD, *SPLNBR, *SPLNBRZ, *USRDTA, *USRDFNDDTA, *USRDFNTXT	Optional
<b>MSG</b>	Message	Single values: * <b>DEFAULT</b> , *USRDFNDDTA, *USRDFNTXT, *NONE Other values: <i>Element list</i>	Optional
	Element 1: Content	<i>Character value</i>	
	Element 2: Send as	* <b>TEXTPLAIN</b> , *TEXTHTML	
<b>PCFILE</b>	Attachment file name	<i>Character value</i> , * <b>DEFAULT</b>	Optional
<b>EXTENSION</b>	Attachment extension	<i>Character value</i> , * <b>DFT</b>	Optional
<b>CC</b>	Cc (carbon copy)	Single values: * <b>NONE</b> Other values (up to 300 repetitions): <i>Element list</i>	Optional

	Element 1:	<i>Character value</i> , *CURRENT, *MAILTAG, *PAGDTA, *SPLFOWN, *SPLFCRT, *USRDFNDDTA, *USRDFNTXT, *USRDTAUP, *USRID	
<b>BCC</b>	Bcc (blind carbon copy)	Single values: * <b>NONE</b> Other values (up to 300 repetitions): <i>Element list</i>	Optional
	Element 1:	<i>Character value</i> , *CURRENT, *MAILTAG, *PAGDTA, *SPLFOWN, *SPLFCRT, *USRDFNDDTA, *USRDFNTXT, *USRDTAUP, *USRID	
<b>FROM</b>	From (originator)	<i>Character value</i> , * <b>CURRENT</b> , *SPLFOWN, *SPLFCRT, *MAILSENDER	Optional
<b>CFMDEL</b>	Confirmation of delivery	* <b>NO</b> , *YES, *OBS, Y, N, O	Optional
<b>REPLYTO</b>	Reply to	Single values: * <b>NONE</b> Other values (up to 300 repetitions): <i>Element list</i>	Optional
	Element 1:	<i>Character value</i> , *CURRENT, *MAILTAG, *PAGDTA, *SPLFOWN, *SPLFCRT, *USRDFNDDTA, *USRDFNTXT, *USRDTAUP, *USRID	
<b>CCSID</b>	Target coded character set id	1-65533, *UNICODE, * <b>WINANSI</b> , *UTF8, *BIG5, *GBK, *ISO88591, *ISO88592, *ISO88595, *ISO88597, *ISO88598, *ISO88599, *USASCII, *ISO-8859-1, *ISO-8859-2, *ISO-8859-5, *ISO-8859-7, *ISO-8859-8, *ISO-8859-9, *US-ASCII	Optional
<b>SRCCSID</b>	Source coded character set id	1-65533, * <b>KBDTYPE</b> , *SPLF, *SYSVAL, *JOBDFDFT	Optional
<b>CHRENC</b>	Character encoding of mail	* <b>UTF8</b> , *ISO88591, *ISO88592, *ISO88595, *ISO88596, *ISO88597, *ISO88598, *ISO88599, *BIG5, 1208, 819, 912, 915, 1089, 813, 916, 920, 950	Optional
<b>CMDCHRID</b>	Command character identifier	Single values: * <b>SRCCSID</b> , *SYSVAL, *JOBDFDFT Other values: <i>Element list</i>	Optional
	Element 1: Graphic character set	1-32767	
	Element 2: Code page	1-32767	
<b>PAGERANGE</b>	Page range to print	Single values: *SPLF Other values: <i>Element list</i>	Optional
	Element 1: Starting page	<i>Integer</i> , <b>1</b> , *ENDPAGE	
	Element 2: Ending page	<i>Integer</i> , * <b>END</b>	
<b>PAGDTA</b>	Page data	Single values: * <b>STRPAGGRP</b> , *NONE Other values: <i>Element list</i>	Optional
	Element 1: Line	1-255	
	Element 2: Position	1-378	
	Element 3: Length	1-255	
<b>ADDMAPPGM</b>	Address mapping program	Single values: * <b>NONE</b> Other values: <i>Qualified object name</i>	Optional
	Qualifier 1: Address mapping program	<i>Name</i>	
	Qualifier 2: Library	<i>Name</i> , * <b>LIBL</b> , *CURLIB	
<b>DLTSPLF</b>	Delete file after processing	* <b>NO</b> , *YES, Y, N	Optional
<b>INCOBJ</b>	Include object	Single values: * <b>NONE</b> Other values (up to 64 repetitions): <i>Element list</i>	Optional
	Element 1: Name	<i>Path name</i>	
	Element 2: Send as	*NOTE, * <b>ATTACH</b> , *TEXTPLAIN, *TEXTHTML, *ATTACHPDF, *ATTACHPS	
	Element 3: Multipart/alternative group	1-9, * <b>NONE</b>	
<b>PDFDOCSEC</b>	PDF document security	<i>Element list</i>	Optional
	Element 1: Owner password	<i>Character value</i> , '!', *NONE	
	Element 2: User password	<i>Character value</i> , '!', *NONE	
	Element 3: Allow print	* <b>YES</b> , *NO, 0, 1	
	Element 4: Allow change	* <b>YES</b> , *NO, 0, 1	
	Element 5: Allow copy	* <b>YES</b> , *NO, 0, 1	
	Element 6: Allow annotation	* <b>YES</b> , *NO, 0, 1	
	Element 7: Encryption specification	* <b>V1</b> , *V2, *V5, 0, 16, 32	
	Element 8: Allow form fill-in and sign	* <b>YES</b> , *NO, 0, 1	
	Element 9: Allow accessibility inspection	* <b>YES</b> , *NO, 0, 1	
	Element 10: Allow document assembly	* <b>YES</b> , *NO, 0, 1	
	Element 11: Allow print as image	* <b>YES</b> , *NO, 0, 1	
<b>PDFDOCTTL</b>	PDF document title	<i>Character value</i> , * <b>NONE</b> , *ACGCDE, *PRTTXT, *USRDTA, *USRDFNDDTA, *USRDFNTXT	Optional
<b>PDFDOCSBJ</b>	PDF document subject	<i>Character value</i> , * <b>DEFAULT</b> , *ACGCDE, *PRTTXT, *USRDTA, *USRDFNDDTA, *USRDFNTXT	Optional

<b>PDFDOCATH</b>	PDF document author	Character value, <b>*CRTUSRPRE</b> , *NONE	Optional
<b>PDFDOCKWD</b>	PDF document keywords	Character value, <b>*NONE</b>	Optional
<b>PDFFONTIMB</b>	PDF font imbedding	Single values: <b>*DEFAULT</b> , *NONE, *TYPES13 Other values (up to 5 repetitions): <b>*DEFAULT</b> , *NONE, *TYPE3, *TYPE1, *TYPES13, *FGID, *TRUETYPE, 0, 1, 2, 3, 4, 8, -3	Optional
<b>PDFDOCOPN</b>	PDF document open options	Element list	Optional
	Element 1: Initial page mode	<b>*DEFAULT</b> , *PAGEONLY, *BOOKMARK, *THUMBNAIL, *FULLSCREEN, X'00', 1, 2, 3, 4	
	Element 2: Page mode after *FULLSCREEN	<b>*DEFAULT</b> , *PAGEONLY, *BOOKMARK, *THUMBNAIL, X'00', 1, 2, 3	
	Element 3: Page layout	<b>*DEFAULT</b> , *SINGLEPAGE, *ONECOL, *TWOCOLLEFT, *TWOCOLRIGHT, X'00', 1, 2, 3, 4	
	Element 4: Hide tool bars	<b>*NO</b> , *YES, 0, 1	
	Element 5: Hide menu bar	<b>*NO</b> , *YES, 0, 1	
	Element 6: Hide user interface elements	<b>*NO</b> , *YES, 0, 1	
	Element 7: Resize window to initial page	<b>*NO</b> , *YES, 0, 1	
	Element 8: Center window on screen	<b>*NO</b> , *YES, 0, 1	
	Element 9: Display document title	<b>*NO</b> , *YES, 0, 1	
	Element 10: Magnification	8-1600, <b>*DEFAULT</b> , *PAGE, *WIDTH, *HEIGHT, *PCT1600, *PCT800, *PCT400, *PCT200, *PCT150, *PCT125, *PCT100, *PCT75, *PCT50, *PCT25	
	Element 11: Page number	Integer, <b>*DEFAULT</b> , *LAST	
<b>PDFOVL</b>	PDF media overlay	Single values: <b>*NONE</b> , *GREENBAR, *BLUEBAR, *COPY Other values: <i>Qualified object name</i>	Optional
	Qualifier 1: PDF media overlay	<i>Name</i>	
	Qualifier 2: Library	<i>Name</i> , <b>*LIBL</b> , *CURLIB	
<b>PDFBKMSTY</b>	PDF bookmark style	<b>*ONELEVEL</b> , *NONE, *TWOLEVEL, 0, 1, 2	Optional
<b>PDFBKMSRC</b>	PDF bookmark data source	Values (up to 8 repetitions): <i>Element list</i>	Optional
	Element 1: Line	1-255, <b>*DOCIDXTAGP</b> , *DOCIDXTAG, *DOCIDXTAGG, *STRPAGGRP	
	Element 2: Position	1-378, 0	
	Element 3: Length	1-255, 0	
	Element 4: Name	Character value	
<b>FIDELITY</b>	Fidelity	<i>Name</i> , <b>*RESOURCE</b> , *CONTENT	Optional
<b>SGNKEY</b>	Signing key	Single values: <b>*DEFAULT</b> , *NONE Other values: <i>Element list</i>	Optional
	Element 1: Application ID	Character value	
<b>PDFSGNKEY</b>	PDF document signing key	Single values: <b>*DEFAULT</b> , *NONE Other values: <i>Element list</i>	Optional
	Element 1: Application ID	Character value	
<b>HTMCSS</b>	Style sheet	Path name, <b>*DEFAULT</b>	Optional
<b>USRID</b>	Obsolete (Originator)	Single values: <b>*CURRENT</b> , *DEFAULT, *SPLFOWN, *SPLFCRT, *MAILSENDER Other values: <i>Element list</i>	Optional
	Element 1: User ID	Character value	
	Element 2: Address	Character value	

## Spooled file name (FILE)

Specifies the name of the spooled file to process. CHAR(10)

This is a required parameter.

- \*LASTCRT** The last spooled file created by the current job or thread is identified using the QSPRILSP API and processed. This is useful for jobs that create spooled files under other user profiles, which consequently end up in the user's QPRTJOB. When **\*LASTCRT** is specified, the JOB() and SPLNBR() parameters are ignored.
- name** Specify the name of the spooled file.

## Job name (JOB)

Specifies the job that contains the spooled file.

## Single values

**\***                      The job that issued the command.

### Qualifier 1: Job name

**name**                      Specify the name of the job. CHAR(10)

### Qualifier 2: User

**name**                      Specify the name that identifies the user profile under which the job is run. CHAR(10)

### Qualifier 3: Number

**00000-99999**              Specify the system assigned job number. CHAR(6)

---

## Spooled file number (SPLNBR)

Specifies the number of the spooled file. INT(4)

**\*LAST**                      The highest numbered spooled file with the specified file name is used.  
**\*ONLY**                      The number of the only spooled file with the specified file name is used.  
**1-99999**                      Specify the number of the spooled file.

---

## Transform to perform (TRANSFORM)

Specifies the manner in which the spooled file is transformed. CHAR(15)

**\*TXT**                              Use ASCII Text conversion.  
**\*TXTFF**                            Use ASCII Text conversion ending each page with a form feed instead of filling with blank lines.  
**\*TXTTRIM**                        Use ASCII Text conversion filling all but the last page with blank lines.  
**\*PDFLETTER**                      Use PDF Portable Document Format conversion with a page size of 8.5" x 11".  
**\*PDFLEGAL**                      Use PDF Portable Document Format conversion with a page size of 8.5" x 14".  
**\*PDFSTATEMENT**                Use PDF Portable Document Format conversion with a page size of 5.5" x 8.5".  
**\*PDFEXECUTIVE**                Use PDF Portable Document Format conversion with a page size of 7.25" x 10.5".  
**\*PDFLEDGER**                    Use PDF Portable Document Format conversion with a page size of 11" x 17".  
**\*PDFA3**                            Use PDF Portable Document Format conversion with a page size of A3.  
**\*PDFA4**                            Use PDF Portable Document Format conversion with a page size of A4.  
**\*PDFA5**                            Use PDF Portable Document Format conversion with a page size of A5.  
**\*PDFB4**                            Use PDF Portable Document Format conversion with a page size of B4.  
**\*PDFB5**                            Use PDF Portable Document Format conversion with a page size of B5.  
**\*PDFLETTERLEGAL**              Use PDF Portable Document Format conversion with a page size of 8.5" x 11" for drawer 1 and 8.5" x 14" for drawer 2.  
**\*PDFLEGALLETTER**              Use PDF Portable Document Format conversion with a page size of 8.5" x 14" for drawer 1 and 8.5" x 11" for drawer 2.  
**\*PDFALETTER**                    Use PDF/A Portable Document Format conversion with a page size of 8.5" x 11".  
**\*PDFALEGAL**                    Use PDF/A Portable Document Format conversion with a page size of 8.5" x 14".  
**\*PDFASTATEMENT**                Use PDF/A Portable Document Format conversion with a page size of 5.5" x 8.5".  
**\*PDFAEXECUTIVE**                Use PDF/A Portable Document Format conversion with a page size of 7.25" x 10.5".  
**\*PDFALEDGER**                    Use PDF/A Portable Document Format conversion with a page size of 11" x 17".  
**\*PDFAA3**                            Use PDF/A Portable Document Format conversion with a page size of A3.  
**\*PDFAA4**                            Use PDF/A Portable Document Format conversion with a page size of A4.  
**\*PDFAA5**                            Use PDF/A Portable Document Format conversion with a page size of A5.  
**\*PDFAB4**                            Use PDF/A Portable Document Format conversion with a page size of B4.  
**\*PDFAB5**                            Use PDF/A Portable Document Format conversion with a page size of B5.  
**\*PDFALTRLGL**                    Use PDF/A Portable Document Format conversion with a page size of 8.5" x 11" for drawer 1 and 8.5" x 14" for drawer 2.  
**\*PDFALGLLTR**                    Use PDF/A Portable Document Format conversion with a page size of 8.5" x 14" for drawer 1 and 8.5" x 11" for drawer 2.  
**\*PDFPAGESIZE**                    Use PDF Portable Document Format conversion using the page size as described by the spooled file's

	attributes.
<b>*RTFLETTER</b>	Use RTF Microsoft Rich Text Format conversion with a page size of 8.5" x 11".
<b>*RTFLEGAL</b>	Use RTF Microsoft Rich Text Format conversion with a page size of 8.5" x 14".
<b>*RTFSTATEMENT</b>	Use RTF Microsoft Rich Text Format conversion with a page size of 5.5" x 8.5".
<b>*RTFEXECUTIVE</b>	Use RTF Microsoft Rich Text Format conversion with a page size of 7.25" x 10.5".
<b>*RTFLEDGER</b>	Use RTF Microsoft Rich Text Format conversion with a page size of 11" x 17".
<b>*RTFA3</b>	Use RTF Microsoft Rich Text Format conversion with a page size of A3.
<b>*RTFA4</b>	Use RTF Microsoft Rich Text Format conversion with a page size of A4.
<b>*RTFA5</b>	Use RTF Microsoft Rich Text Format conversion with a page size of A5.
<b>*RTFB4</b>	Use RTF Microsoft Rich Text Format conversion with a page size of B4.
<b>*RTFB5</b>	Use RTF Microsoft Rich Text Format conversion with a page size of B5.
<b>*HTMLCSS</b>	Use HTM Hyper Text Markup Language Format conversion with a style sheet.
<b>*HTMLBASIC</b>	Use HTML Hyper Text Markup Language Format conversion.
<b>*POSTSCRIPT</b>	Use PostScript conversion.
<b>*FFT BASIC</b>	Use FFT IBM Final Form Text conversion.
<b>*TIFFLETTER</b>	Use TIFF Tag Image File Format Group 4 specification conversion with letter size paper implied.
<b>*TIFFLEGAL</b>	Use TIFF Tag Image File Format Group 4 specification conversion with legal size paper implied.
<b>*TIFFEXECUTIVE</b>	Use TIFF Tag Image File Format Group 4 specification conversion with executive size paper implied.
<b>*TIFFLEDGER</b>	Use TIFF Tag Image File Format Group 4 specification conversion with ledger size paper implied.
<b>*TIFFA3</b>	Use TIFF Tag Image File Format Group 4 specification conversion with A3 size paper implied.
<b>*TIFFA4</b>	Use TIFF Tag Image File Format Group 4 specification conversion with A4 size paper implied.
<b>*TIFFA5</b>	Use TIFF Tag Image File Format Group 4 specification conversion with A5 size paper implied.
<b>*TIFFB4</b>	Use TIFF Tag Image File Format Group 4 specification conversion with B4 size paper implied.
<b>*TIFFB5</b>	Use TIFF Tag Image File Format Group 4 specification conversion with B5 size paper implied.
<b>*TIFFCONT80</b>	Use TIFF Tag Image File Format Group 4 specification conversion with continuous 8.0 inch paper implied.
<b>*TIFFCONT132</b>	Use TIFF Tag Image File Format Group 4 specification conversion with continuous 13.2 inch paper implied.
<b>*TIFF</b>	Use TIFF Tag Image File Format Group 4 specification conversion.
<b>*TIFFPB</b>	Use TIFF Tag Image File Format Pack Bit specification conversion.
<b>*AFPPRINTFILE</b>	Use AFP print file conversion. Page segments and overlays, but not fonts, are included in the generated file.
<b>*AFPPRINTFILE2</b>	Use AFP print file conversion. Page segments, overlays and fonts are included in the generated file.
<b>*WSCST</b>	Use HPT IBM i Host Print Transform conversion with the specified workstation customizing object.
<b>*NONE</b>	Use no conversion conversion.
<b>*NONEPDF</b>	Same processing as *NONE but with an implied default extension of .PDF. This is useful for processing *USERASCII spooled files containing .PDF documents.
<b>character-value</b>	Use HPT IBM i Host Print Transform conversion.

---

## To (recipient) (TOSMTPNAME)

Specifies the email address(es) to which the spooled file is sent. CHAR(128)

### Single values

<b>*CURRENT</b>	The email address stored in the directory entry associated with the user running the command is used. <b>Note:</b> If a value is specified on the To (distribution list) (TOUSRID) parameter it overrides *CURRENT.
<b>*MAILTAG</b>	The email address specified in the MAILTAG() keyword as stored in the spooled file's User Defined Data is used. <b>Note:</b> Instructions for storing an email address in the spooled file's User Defined Data can be found in: <i>Info Print Server User's Guide G544-5775</i> .
<b>*PAGDTA</b>	Recipient information is taken from data on each page of the spooled file. The location of the data is specified using the Page data (PAGDTA) parameter. When no program name is specified on the Address mapping program (ADDMAPPGM) parameter, the data is used as an email address. When a program name is specified on the Address mapping program (ADDMAPPGM) parameter, the data is passed to the program and the email address returned by it is used.

All pages with identical data are grouped together and sent as a single email. Since there can be different data on various pages, \*PAGDTA results in a separate email for each unique data. Pages that are not associated with any recipient information (i.e. pages outside a page group and PAGDTA(\*STRPAGRP) specified) are not sent.

<b>*SPLFOWN</b>	The email address stored in the directory entry associated with the user that owns the spooled file is used.
<b>*SPLFCRT</b>	The email address stored in the directory entry associated with the user who created the spooled file is used. This can differ from the owning user if the spooled file was created on another system.
<b>*USRDFNDTA</b>	The email address stored in the spooled file's User Defined Data is used. <b>Note:</b> Similar to *MAILTAG but without the keyword MAILTAG().
<b>*USRDFNTXT</b>	The email address stored in the spooled file's User Defined Text is used.
<b>*USRDTAUP</b>	The spooled file's user data is treated as a user name and the email address stored in the directory entry associated with the user name is used.
<b>*NONE</b>	An email address is not specified.
<b>*STRPAGGRP</b>	This special value has been replaced by *PAGDTA with PAGDTA(*STRPAGGRP) specified.

### Other values (up to 300 repetitions)

**email-address** Specify the email address of the recipient.

## Workstation customizing object (WSCST)

Specifies the work station customizing object used to transform the spooled file when TRANSFORM(\*WSCST) is specified. CHAR(10), CHAR(10)

### Single values

**\*NONE** No work station customizing object is specified.

### Element 1: Workstation customizing object

**name** Specify the name of the work station customizing object.

### Qualifier 2: Library

**\*LIBL** All libraries in the thread's library list are searched.

**\*CURLIB** Use the current library for the job. If no library is specified as the current library for the job, QGPL is used.

**name** Specify the name of the library.

## To (distribution list) (TOUSRID)

**Note:** If this parameter is specified and the To (recipient) (TOSMTPNAME) parameter is not specified, the entered value overrides the default value of the To (recipient) (TOSMTPNAME) parameter.

Specifies the Distribution list or network user to receive the email. CHAR(8), CHAR(8)

### Single values

**\*NONE** A network user or distribution list is not specified.

**\*CURRENT** The user ID and address of the user running the command are used.

**\*SPLFCRT** The user ID and address of the user who created the spooled file are used. This can differ from the owning user if the spooled file was created on another system.

**\*SPLFOWN** The user ID and address of the user that owns the spooled file are used.

**\*GATEWAY** The context switching internet gateway is used to send to the email address specified.

**Note:** This value is obsolete but included for compatibility reasons.

### Element 1: User ID

**character-value** Specify the user ID (DEN) of the network user. CHAR(8)

### Element 2: Address

**character-value** Specify the address (DGN) of the network user. CHAR(8)

---

## Send as (SEND)

Specifies the manner in which the spooled file is sent. CHAR(10)

<b>*ATTACH</b>	Send the spooled file as an attached file using MIME. For TXT transforms the MIME part specifies a content type of "text/plain". For the PDF transforms the MIME part specifies a content type of "application/pdf". For PostScript transforms the MIME part specifies a content type of "application/postscript". For HTML transforms the MIME part specifies a content type of "text/html". For all other transforms, "application/octet-stream" is specified.
<b>*TEXTHTML</b>	Send the results of converting the spooled file in the body of the mail message specifying content type "text/html". <b>Note:</b> Some servers disregard this request and form an attachment from the message in all cases. Some servers disregard this request for the second and subsequent body parts. If this is the case, try MSG(*NONE).
<b>*TEXTPLAIN</b>	Send the results of converting the spooled file in the body of the mail message specifying content type "text/plain". <b>Note:</b> Some servers disregard this request and form an attachment from the message in all cases. Some servers disregard this request for the second and subsequent body parts. If this is the case, try MSG(*NONE).
<b>*NOTE</b>	Same as *TEXTPLAIN which is preferred.

---

## Subject (SUBJECT)

Specifies the subject for the generated email. CHAR(60)

<b>*DEFAULT</b>	The subject of the email is generated from spooled file attributes.
<b>*NONE</b>	No subject is included in the email.
<b>character-value</b>	Specify the subject of the email.

SpoolMail provides several special values that can be used to construct dynamic subject content. When the special values are found, the associated data is blank trimmed and substituted into the subject specified when it is processed. If the data associated with a special value is blank, "BLANK" is substituted. The special values must be delimited by an underscore ( \_ ) a period ( . ) a slash ( / ) or a backslash ( \ ) or a blank.

The spooled file splitting special values are:

<b>*PAGDTA</b>	The data found based on criteria specified in the Page data (PAGDTA) parameter.
----------------	---

The spooled file attribute related special values are:

<b>*ACGCDE</b>	Accounting code CHAR(15).
<b>*CRTSYS</b>	System created on originally CHAR(8). This can differ from the current system's name if the spooled file was sent from another System i.
<b>*CRTUSR</b>	User creating originally CHAR(10). This can differ from the *JOBUSR value if the spooled file was sent from another System i.
<b>*FILE</b>	Spooled file name CHAR(10).
<b>*FILE8</b>	Same as *FILE truncated to CHAR(8).
<b>*FORMTYPE</b>	Spooled file form type CHAR(10). Make sure special values in the data are compatible with usage. For example few file systems allow * in a name. If the form type is *STD, the name will be invalid.
<b>*JOBNAM</b>	Name portion of the job containing the spooled file CHAR(10).
<b>*JOBNAM8</b>	Same as *JOBNAM truncated to CHAR(8).
<b>*JOBNBR</b>	Job number of the job containing the spooled file CHAR(6).
<b>*JOBUSR</b>	User portion of the job containing the spooled file CHAR(10).
<b>*JOBUSR8</b>	Same as *JOBUSR truncated to CHAR(8).
<b>*OUTQ</b>	Output queue the file is on CHAR(10).
<b>*PAGECOUNT</b>	Spooled file page count converted to text. CHAR(6) or more.
<b>*PAGECNTZ</b>	Spooled file page count converted to text with leading zeros removed. Length varies.
<b>*PGM</b>	Program that opened the file CHAR(10).
<b>*PGM8</b>	Same as *PGM truncated to CHAR(8).
<b>*PRTTXT</b>	Print text CHAR(30).
<b>*SPLCDAT</b>	Date the spooled file was open CHAR(7) CYYMMDD.
<b>*SPLCTIM</b>	Time the spooled file was opened CHAR(6) HHMMSS.
<b>*SPLCCYY</b>	Century-year portion of the date the spooled file was open CHAR(3) CYY.



<b>*SPLCY</b>	Year portion of the date the spooled file was open CHAR(2) YY.
<b>*SPLCMM</b>	Month portion of the date the spooled file was open CHAR(2) MM.
<b>*SPLCDD</b>	Day portion of the date the spooled file was open CHAR(2) DD.
<b>*SPLNBR</b>	Spooled file number converted to text. CHAR(6).
<b>*SPLNBRZ</b>	Spooled file number converted to text with leading zeros removed. Length varies.
<b>*USRDFNDDTA</b>	User defined data CHAR(255).
<b>*USRDFNTXT</b>	User-defined text taken from the user profile when the spooled file was created. Add text to a user profile using the CHGUSRPRTI command CHAR(100).
<b>*USRDTA</b>	User data CHAR(10).

## Message (MSG)

Specifies a message to include in the email, and its content type.

### Single values

<b>*DEFAULT</b>	The message in the email is generated from spooled file attributes.
<b>*USRDFNDDTA</b>	The spooled file's user defined data is used as the message.
<b>*USRDFNTXT</b>	The spooled file's user defined text is used as the message.
<b>*NONE</b>	This parameter does not place a message in the email.

### Element 1: Content

***character-value*** Specify the content placed in the email. CHAR(5000)

### Element 2: Send as

<b>*TEXTPLAIN</b>	Copy the content into the body of the mail message specifying content type text/plain. Line breaks can be added by placing hex value X'0D25' in the data. See manual section "Adding Line Breaks to the Message" for coding details.
<b>*TEXTHTML</b>	Copy the content into the body of the mail message specifying content type text/html. Line breaks can be added by placing ' ' in the data. See manual section "Adding Line Breaks to the Message" for coding details.

## Attachment file name (PCFILE)

Specifies the file name to use when naming the attachment file. This parameter is only used when SEND(\*ATTACH) is specified. CHAR(32)

<b>*DEFAULT</b>	A default file name is generated.
<b><i>name</i></b>	Specify the name of the attached file.

## Attachment extension (EXTENSION)

Specifies the file extension to use when naming the attachment file. This parameter is only used when SEND(\*ATTACH) is specified. CHAR(3)

<b>*DFT</b>	The extension is determined by the transform performed:	
	<b><i>Transform</i></b>	<b>- Extension.</b>
	<b>*TXTxxx</b>	- txt
	<b>*PDFxxx</b>	- pdf
	<b>*RTFxxx</b>	- rtf
	<b>*HTMxxx</b>	- htm
	<b>*NONE</b>	- spl
	<b>*POSTSCRIPT</b>	- ps
	<b>*FFTxxx</b>	- fft
	<b>*AFPxxx</b>	- afp
	<b>*TIFFxx</b>	- tif

**<all other>** - hpt  
**character-value** Specify the attachment file extension to use.

---

## Cc (carbon copy) (CC)

Specifies the email address(es) to which a copy is sent. CHAR(128)

### Single values

**\*NONE** An email address is not specified.

### Other values (up to 300 repetitions)

**\*CURRENT** The email address stored in the directory entry associated with the user running the command is used.  
**\*MAILTAG** The email address specified in the MAILTAG() keyword as stored in the spooled file's User Defined Data is used.

**Note:** Instructions for storing an email address in the spooled file's User Defined Data can be found in: *Info Print Server User's Guide G544-5775*.

**\*PAGDTA** Recipient information is taken from data on each page of the spooled file. The location of the data is specified using the Page data (PAGDTA) parameter. When no program name is specified on the Address mapping program (ADDMAPPING) parameter, the data is used as an email address. When a program name is specified on the Address mapping program (ADDMAPPING) parameter, the data is passed to the program and the email address returned by it is used.

All pages with identical data are grouped together and sent as a single email. Since there can be different data on various pages, \*PAGDTA results in a separate email for each unique data. Pages that are not associated with any recipient information (i.e. pages outside a page group and PAGDTA(\*STRPAGRP) specified) are not sent.

**\*SPLFOWN** The email address stored in the directory entry associated with the user that owns the spooled file is used.

**\*SPLFCRT** The email address stored in the directory entry associated with the user who created the spooled file is used. This can differ from the owning user if the spooled file was created on another system.

**\*USRDFNDTA** The email address stored in the spooled file's User Defined Data is used.

**Note:** Similar to \*MAILTAG but without the keyword MAILTAG().

**\*USRDFNTXT** The email address stored in the spooled file's User Defined Text is used.

**\*USRDTAUP** The spooled file's user data is treated as a user name and the email address stored in the directory entry associated with the user name is used.

**\*USRID** Specify the directory entry or distribution list that supplies the email address(es). The correct form is: \*USRID:NAME:ADDRESS where NAME is either a directory entry's "User ID" or a distribution list's "List ID" and where ADDRESS is either a directory entry's "Address" or a distribution list's "List ID qualifier". The parameter allows lower case data, however this value must be specified all UPPER CASE.

**character-value** Specify the email address to receive a copy.

---

## Bcc (blind carbon copy) (BCC)

Specifies the email address(es) to which a blind copy is sent. CHAR(128)

### Single values

**\*NONE** An email address is not specified.

### Other values (up to 300 repetitions)

**\*CURRENT** The email address stored in the directory entry associated with the user running the command is used.  
**\*MAILTAG** The email address specified in the MAILTAG() keyword as stored in the spooled file's User Defined Data is used.

**Note:** Instructions for storing an email address in the spooled file's User Defined Data can be found in: *Info Print Server User's Guide G544-5775*.

**\*PAGDTA** Recipient information is taken from data on each page of the spooled file. The location of the data is specified using the Page data (PAGDTA) parameter. When no program name is specified on the Address mapping program (ADDMAPPING) parameter, the data is used as an email address. When a program name is specified on the Address mapping program (ADDMAPPING) parameter, the data is passed to the program and the email address returned by it is used.

All pages with identical data are grouped together and sent as a single email. Since there can be different data on various pages, \*PAGDTA results in a separate email for each unique data. Pages that are not associated with any recipient information (i.e. pages outside a page group and PAGDTA(\*STRPAGRP) specified) are not sent.

<b>*SPLFOWN</b>	The email address stored in the directory entry associated with the user that owns the spooled file is used.
<b>*SPLFCRT</b>	The email address stored in the directory entry associated with the user who created the spooled file is used. This can differ from the owning user if the spooled file was created on another system.
<b>*USRDFNDDTA</b>	The email address stored in the spooled file's User Defined Data is used. <b>Note:</b> Similar to *MAILTAG but without the keyword MAILTAG().
<b>*USRDFNTXT</b>	The email address stored in the spooled file's User Defined Text is used.
<b>*USRDTAUP</b>	The spooled file's user data is treated as a user name and the email address stored in the directory entry associated with the user name is used.
<b>*USRID</b>	Specify the directory entry or distribution list that supplies the email address(es). The correct form is: *USRID:NAME:ADDRESS where NAME is either a directory entry's "User ID" or a distribution list's "List ID" and where ADDRESS is either a directory entry's "Address" or a distribution list's "List ID qualifier". The parameter allows lower case data, however this value must be specified all UPPER CASE.
<b>character-value</b>	Specify the email address to receive a blind copy.

---

## From (originator) (FROM)

Specifies the email address that appears as the **From** on the generated the email. You can use this to control the address used when the recipient replies to the email.

**Note:** One or more of the special values for this parameter access the system distribution directory to determine an email address based on the implied user profile. If the user profile does not have a directory entry (I.e. the user has not been enrolled), the user name is used to construct an email address. If the user has been enrolled but an email address has not been specified on the directory entry, the user id and address are used to construct an email address. In either case, the constructed address, in all likelihood, is not a valid email address. The email will deliver but recipient replies will be lost (bounce).

<b>*CURRENT</b>	The email address stored in the directory entry associated with the user running the command is used.
-----------------	---

**Note:** If a value is specified on the Obsolete (Originator) (USRID) parameter it overrides \*CURRENT.

<b>*SPLFOWN</b>	The email address stored in the directory entry associated with the user that owns the spooled file is used.
<b>*SPLFCRT</b>	The email address stored in the directory entry associated with the user who created the spooled file is used. This can differ from the owning user if the spooled file was created on another system.
<b>*MAILSENDER</b>	The email address found in the directory entry associated with the user profile specified in the MAILSENDER() keyword as stored in the spooled file's User Defined Data is used. <b>Note:</b> Instructions for storing a sending user profile in the spooled file's User Defined Data can be found in: <i>Info Print Server User's Guide G544-5775</i> .
<b>character-value</b>	Specify the email address of the originator.

---

## Confirmation of delivery (CFMDEL)

Specifies whether a request for a read receipt is sent with the message. Message recipients can choose whether or not to send receipts. If the message recipient agrees to send a read receipt, the receipt will be sent when the message is opened.

<b>*NO</b>	Confirmation of delivery is not requested.
<b>*YES</b>	Confirmation of delivery is requested.
<b>*OBS</b>	Confirmation of delivery is requested as with *YES but the obsolete non-standard "Return-Receipt-To" header field is also included in the message. Some mail user/transport agents understand the obsolete field but do not understand the standard "Disposition-Notification-To" supplied by *YES.

---

## Reply to (REPLYTO)

Specifies the email address(es) to which replies should be sent when replies should go to an address other than the From (originator) (FROM) parameter. or to multiple addresses. CHAR(128)

## Single values

**\*NONE** Replies are directed to the address the email is from.

## Other values (up to 300 repetitions)

**\*CURRENT** The email address stored in the directory entry associated with the user running the command is used.

**\*MAILTAG** The email address specified in the MAILTAG() keyword as stored in the spooled file's User Defined Data is used.

**Note:** Instructions for storing an email address in the spooled file's User Defined Data can be found in: *Info Print Server User's Guide G544-5775*.

**\*PAGDTA** Recipient information is taken from data on each page of the spooled file. The location of the data is specified using the Page data (PAGDTA) parameter. When no program name is specified on the Address mapping program (ADDMAPPGM) parameter, the data is used as an email address. When a program name is specified on the Address mapping program (ADDMAPPGM) parameter, the data is passed to the program and the email address returned by it is used.

All pages with identical data are grouped together and sent as a single email. Since there can be different data on various pages, \*PAGDTA results in a separate email for each unique data. Pages that are not associated with any recipient information (i.e. pages outside a page group and PAGDTA(\*STRPAGRP) specified) are not sent.

**\*SPLFOWN** The email address stored in the directory entry associated with the user that owns the spooled file is used.

**\*SPLFCRT** The email address stored in the directory entry associated with the user who created the spooled file is used. This can differ from the owning user if the spooled file was created on another system.

**\*USRDFNDTA** The email address stored in the spooled file's User Defined Data is used.

**Note:** Similar to \*MAILTAG but without the keyword MAILTAG().

**\*USRDFNTXT** The email address stored in the spooled file's User Defined Text is used.

**\*USRDTAUP** The spooled file's user data is treated as a user name and the email address stored in the directory entry associated with the user name is used.

**\*USRID** Specify the directory entry or distribution list that supplies the email address(es). The correct form is: \*USRID:NAME:ADDRESS where NAME is either a directory entry's "User ID" or a distribution list's "List ID" and where ADDRESS is either a directory entry's "Address" or a distribution list's "List ID qualifier". The parameter allows lower case data, however this value must be specified all UPPER CASE.

**character-value** Specify the email address to which replies should be directed.

---

## Target coded character set id (CCSID)

Specifies the ASCII coded character set identifier (CCSID) that is used to map data in outgoing mail. INT(4)

**\*WINANSI** The default coded character set identifier (1252).

**\*UNICODE** ISO/IEC 10646 Universal Coded Character Set Level 2 (13488).

**\*UTF8** Unicode 8 bit transfer encoding (1208).

**\*ISO88591** ISO-8859-1 Latin 1 Western European "8-bit ASCII" (819).

**\*ISO88592** ISO-8859-2 ROECE Latin 2 Eastern European (912).

**\*ISO88595** ISO-8859-5 Cyrillic (915).

**\*ISO88597** ISO-8859-7 Greek (813).

**\*ISO88598** ISO-8859-8 Hebrew (916).

**\*ISO88599** ISO-8859-9 Latin 9 other Latin-using languages (920).

**\*BIG5** Traditional Chinese, Taiwan Industry Standard PC Data Mixed for Big5 (950).

**integer** Specify the coded character set identifier to use.

---

## Source coded character set id (SRCCSID)

Specifies the coded character set identifier (CCSID) used to create the spooled file. INT(4)

**\*KBDTYPE** The system determines the coded character set identifier value from the QKBDTYPE system value.

**\*SPLF** The spooled file's attributes are inspected to determine its coded character set identifier value.

**\*SYSVAL** The system determines the coded character set identifier value from the QCHRID system value.

**\*JOBDFT** The system uses the current job's default coded character set identifier.

**integer** Specify the coded character set identifier to use.

---

## Character encoding of mail (CHRENC)

Specifies the character set used to create the email and MIME headers (the transfer encoding).

<b>*UTF8</b>	Unicode 8 bit transfer encoding (1208).
<b>*ISO88591</b>	ISO-8859-1 Latin 1 Western European "8-bit ASCII" (819).
<b>*ISO88592</b>	ISO-8859-2 ROECE Latin 2 Eastern European (912).
<b>*ISO88595</b>	ISO-8859-5 Cyrillic (915).
<b>*ISO88596</b>	ISO-8859-6 Arabic (1089).
<b>*ISO88597</b>	ISO-8859-7 Greek (813).
<b>*ISO88598</b>	ISO-8859-8 Hebrew (916).
<b>*ISO88599</b>	ISO-8859-9 Latin 9 other Latin-using languages (920).
<b>*BIG5</b>	Traditional Chinese, Taiwan Industry Standard PC Data Mixed for Big5 (950).

---

## Command character identifier (CMDCHRID)

Specifies the character identifier (graphic character set and code page) for the data being entered as command parameter values. The character identifier is related to the display device used to enter the command. INT(2), INT(2)

### Single values

<b>*SRCCCSID</b>	The system determines the graphic character set and code page values for the command parameters from the source coded character set identifier specified on the command.
<b>*SYSVAL</b>	The system determines the graphic character set and code page values for the command parameters from the QCHRID system value.
<b>*JOBDFTCSSID</b>	The system determines the graphic character set and code page values for the command parameters from the job's default coded character set identifier.

### Element 1: Graphic character set

*integer* Specify the graphic character set.

### Element 2: Code page

*integer* Specify the code page.

---

## Page range to print (PAGERANGE)

Specifies the starting and ending pages to process.

### Single values

**\*SPLF** The page range specified in the spooled file's attributes is used.

### Element 1: Starting page

1 Processing begins at page 1.  
**\*ENDPAGE** The starting page to print is the ending page to print. Only the ending page is printed.  
*integer* Specify the starting page.

### Element 2: Ending page

**\*END** Processing continues until the end of file.  
*integer* Specify the ending page.

---

## Page data (PAGDTA)

Specifies the location (line, position and length), on the page of the spooled file, from which data is retrieved. INT(2), INT(2), INT(2)

The data is used as recipient information, either an email address or data to be mapped by the program specified on the Address mapping program (ADDMAPPGM) parameter.

## Single values

**\*STRPAGGRP** Page data is retrieved from the value stored in the DDS STRPAGGRP keyword that is associated with each page of the spooled file.

This value is only valid with \*AFPDS spooled files. Position and length are ignored as data does not appear on the printed page and the length is derived from the value stored.

**\*NONE** Page data location is not specified.

## Element 1: Line

**1-255** Specify the line number where the data is located on the page.

## Element 2: Position

**1-378** Specify the position where the data is located in the line. Valid values range from 1 through 378. The value specified plus the data length should be less than the number of print positions in the spooled file.

## Element 3: Length

**1-255** Specify the length of the data. The value specified plus the start position should be less than the number of print positions in the spooled file.

---

## Address mapping program (ADDMAPPGM)

Specifies the name of a customer supplied program that calculates an email address based on data from the spooled file. CHAR(10), CHAR(10)

When specified, the program is call by SpoolMail to calculate an email address based on data retrieved by the Page data parameter. The program is passed 3 parameters. The first, CHAR(256), is filled by the program with the calculated email address. The second, CHAR(256), contains the data found on the page. The third CHAR(4096), contains the spooled files attributes. See file SPOOLMAIL/SMSOURCE for more details.

## Single values

**\*NONE** No address mapping is performed.

## Element 1: Address mapping program

**name** Specify the name of the program.

## Qualifier 2: Library

**\*LIBL** All libraries in the thread's library list are searched.

**\*CURLIB** Use the current library for the job. If no library is specified as the current library for the job, QGPL is used.

**name** Specify the name of the library.

---

## Delete file after processing (DLTSPLF)

Specifies whether or not to delete the specified spooled file after it has been successfully processed. CHAR(1)

**\*NO** Do not delete the spooled file.

**\*YES** Delete the spooled file after it has been successfully processed.

**Note:** :This value can not be used when the command is run by a Gumbo logical printer.

---

## Include object (INCOBJ)

Specifies the path name of an additional object (stream file) to include in the generated email message. For example a stream file containing standard terms and conditions can be included as an additional attachment. A maximum of 64 path names can be specified.

For more information on specifying path names, see *Programming > Control language > CL concepts > IBM i objects > Object naming rules* topic in the IBM i Information Center at [http://publib.boulder.ibm.com/series/CHAR\(5000\)](http://publib.boulder.ibm.com/series/CHAR(5000))

### Single values

**\*NONE** No objects are sent.

#### Element 1: Name

**path-name** Specify an object path name.

#### Element 2: Send as

**\*ATTACH** Send the object as an attached file using MIME and specifying "application/octet-stream".

**\*TEXTPLAIN** Copy the object into the body of the mail message specifying content type text/plain.

**Note:** Some servers disregard this request and form an attachment from the message in all cases. Some servers disregard this request for the second and subsequent body parts. If this is the case, try MSG(\*NONE).

**\*TEXTHTML** Copy the object into the body of the mail message specifying content type text/html.

**Note:** Some servers disregard this request and form an attachment from the message in all cases. Some servers disregard this request for the second and subsequent body parts. If this is the case, try MSG(\*NONE).

**\*ATTACHPDF** Send the object as an attached file using MIME and specifying "application/pdf". Use this value if the attached file contains Adobe's Portable Document Format (pdf) data.

**\*ATTACHPS** Send the object as an attached file using MIME and specifying "application/postscript". Use this value if the attached file contains postscript data.

**\*NOTE** Same as \*TEXTPLAIN which is preferred.

#### Element 3: Multipart/alternative group

**\*NONE** The object is not a member of a "multipart/alternative" group.

**1-9** Specify a group number for forming "multipart/alternative" groups. All objects with the same group number are members of a "multipart/alternative" in the generated email.

---

## PDF document security (PDFDOCSEC)

Specifies how Portable Document Format (PDF) files are secured.

**Note:** This parameter is ignored for transforms except those that generate Adobe's Portable Document Format (PDF).

PDF documents can be encrypted to protect their contents from unauthorized access. An encrypted PDF document has two passwords: an owner password and a user password. The PDF document also specifies operations that should be restricted even when the PDF document is decrypted. When opening an encrypted PDF document, Adobe's Acrobat Reader prompts for a password, if one is required. When the correct user password is supplied, the PDF document is opened and decrypted but operations are restricted; when the owner password is supplied, all operations are allowed. The owner password is required to change these passwords and restrictions.

A PDF document is encrypted whenever a user or owner password or restrictions are supplied for the PDF document. However, a user is prompted for a password on opening a PDF document only if the PDF document has a user password.

#### Element 1: Owner password CHAR(32)

**\*NONE** The PDF document does not have an owner password. Unlike most special values, this is case sensitive.

**character-value** Specify the password required to perform owner functions for the PDF document (case sensitive).

#### Element 2: User password CHAR(32)

**\*NONE** The PDF document does not have a user password. Unlike most special values, this is case sensitive.

**character-value** Specify the password required to open the PDF document (case sensitive).

### Element 3: Allow print

- \*YES** Printing of the PDF document is allowed.
- \*NO** The PDF document can not be printed.

### Element 4: Allow change

- \*YES** Changing of the PDF document is allowed.
- \*NO** The PDF document can not be changed.

### Element 5: Allow copy

- \*YES** Copying from the PDF document is allowed.
- \*NO** Portions of the PDF document can not be copied.

### Element 6: Allow annotation

- \*YES** Annotation of the PDF document is allowed.
- \*NO** The PDF document can not be annotated.

### Element 7: Encryption specification INT(2)

- \*V1** Version 1, which uses 40-bit encryption and is compatible with Acrobat Reader 4.0 or later. Value 0.  
**Note:** Version 1 only implements the first four permissions: "Allow print", "Allow change", "Allow copy", and "Allow annotation". Other permissions are ignored and readers treat them as if \*YES was specified.
- \*V2** Version 2, which uses 128-bit encryption and is compatible with Acrobat Reader 5.0 or later. Value 16.
- \*V5** Version 5, which uses 256-bit Advanced Encryption Standard (AES) and is compatible with Acrobat Reader 9.0 or later. Value 32.

### Element 8: Allow form fill-in and sign

- \*YES** Form fill-in and document signing operations are allowed.
- \*NO** The PDF document can not be signed nor forms filled in.

### Element 9: Allow accessibility inspection

- \*YES** Text and graphics can be extracted from the document for the sole purpose of making the contents accessible through assistive technologies such as screen readers or Braille output.
- \*NO** Accessibility inspection is not allowed.

### Element 10: Allow document assembly

- \*YES** Document assembly operations, including insertion, rotation, deletion of pages and creation of bookmarks and thumbnails, are allowed.
- \*NO** Document assembly operations are not allowed.

### Element 11: Allow print as image

- \*YES** Allow the document to be printed if "print as image" is selected.
- \*NO** Do not allow the document to be printed as an image.

**Note:** The permissions are each CHAR(1) and take a value of '0' = \*NO or '1' = \*YES.

---

### PDF document title (PDFDOCTTL)

Specifies the title of the generated Portable Document Format (PDF) PC file. CHAR(256).

**Note:** This parameter is ignored for transforms except those that generate Adobe's Portable Document Format (PDF).

- \*NONE** No title is placed in the generated PC file.
- \*ACGCDE** The spooled file's accounting code is used as the title.
- \*PRTTXT** The spooled file's print text is used as the title.
- \*USRDTA** The spooled file's user data is used as the title.
- \*USRDFNDA** The spooled file's user defined data is used as the title.



**\*USRDFNTXT** User-defined text taken from the user profile when the spooled file was created is used as the title.  
**character-value** Specify the title of the PDF file.

---

### PDF document subject (PDFDOCSBJ)

Specifies the subject of the generated Portable Document Format (PDF) PC file. CHAR(256).

**Note:** This parameter is ignored for transforms except those that generate Adobe's Portable Document Format (PDF).

**\*DEFAULT** A default subject is placed in the generated PC file.  
**\*ACGCDE** The spooled file's accounting code is used as the subject.  
**\*PRTTXX** The spooled file's print text is used as the subject.  
**\*USRDTA** The spooled file's user data is used as the subject.  
**\*USRDFNDTA** The spooled file's user defined data is used as the subject.  
**\*USRDFNTXT** User-defined text taken from the user profile when the spooled file was created is used as the subject.  
**character-value** Specify the subject of the PDF file.

---

### PDF document author (PDFDOCATH)

Specifies the author of the generated Portable Document Format (PDF) PC file. CHAR(256).

**Note:** This parameter is ignored for transforms except those that generate Adobe's Portable Document Format (PDF).

**\*CRTUSRPRF** The user profile that created the spooled file is the author.  
**\*NONE** The generated file does not contain author information.  
**character-value** Specify the author of the PDF file.

---

### PDF document keywords (PDFDOCKWD)

Specifies the keywords associated with the generated Portable Document Format (PDF) PC file. CHAR(256).

**Note:** This parameter is ignored for transforms except those that generate Adobe's Portable Document Format (PDF).

**\*NONE** No keywords are associated with the file.  
**character-value** Specify a list of keywords to associate with the file.

---

### PDF font imbedding (PDFFONTIMB)

Specifies, by font type, which font definitions are included in the generated PDF file. Imbedding fonts improves the fidelity of the PDF at the expense of file size.

**\*DEFAULT** The default setting is used. To change the default setting, use the CHGSMIDFT command.  
**\*NONE** No font definitions are included in the file. All fonts are mapped to Acrobat built-ins.  
**\*TYPE1** Outline font resources are imbedded in the file.  
**\*TYPE3** Raster font resources are subsetted and imbedded in the file.  
**\*TYPES13** Both raster and outline font resources are imbedded in the file.  
**\*FGID** Printer resident font specifications are converted to host resident printer emulation font resources and these are imbedded in the file.  
**\*TRUETYPE** TrueType and OpenType fonts are imbedded in the file.

---

### PDF document open options (PDFDOCOPN)

Specifies how the Acrobat work area appears when a user first opens the PDF document.

**Note:** This parameter is ignored for transforms except those that generate Adobe's Portable Document Format (PDF).

PDF documents can be configured to control the behavior of Acrobat when the document is opened. The configuration settings are the same as those found in the full version of Acrobat under File > Document Properties > Open Options. With the settings, you can control the Initial View, Window Options, and User Interface Options in

effect when the document is opened. You can for example configure the document to hide the Acrobat menu bar, tool bar and window controls and to display in full screen mode when it is opened.

### Element 1: Initial page mode CHAR(1)

- \*DEFAULT** The PDF document does not specify an initial page mode and the viewer's user default settings are used when the document is opened. Value x'00'.
- \*PAGEONLY** Only the page displays, bookmarks and thumbnails are hidden when the document is opened. Value '1'.
- \*BOOKMARK** Bookmarks and pages are displayed when the document is opened. Value '2'.
- \*THUMBNAIL** Thumbnails and pages are displayed when the document is opened. Value '3'.
- \*FULLSCREEN** Full-screen mode is displayed, with no menu bar, window controls, or any other window visible when the document is opened. Value '4'.

### Element 2: Page mode after \*FULLSCREEN CHAR(1)

Specifies how to display the document on exiting full-screen mode. This entry is meaningful only if \*FULLSCREEN is specified for "Page mode after \*FULLSCREEN"; it is ignored otherwise.

- \*DEFAULT** The PDF document does not specify a page mode and the viewer's user default settings are used. Value x'00'.
- \*PAGEONLY** Only the page displays, bookmarks and thumbnails are hidden. Value '1'.
- \*BOOKMARK** Bookmarks and pages are displayed. Value '2'.
- \*THUMBNAIL** Thumbnails and pages are displayed. Value '3'.

### Element 3: Page layout CHAR(1)

- \*DEFAULT** The PDF document does not specify a page layout and the viewer's user default settings are used. Value x'00'.
- \*SINGLEPAGE** Display one page at a time. Value '1'.
- \*ONECOL** Display pages in a single column. Value '2'.
- \*TWOCOLLEFT** Display pages in two columns, with odd-numbered pages on the left. Value '3'.
- \*TWOCOLRIGHT** Display pages in two columns, with odd-numbered pages on the right. Value '4'.

### Element 4: Hide tool bars CHAR(1)

- \*NO** The viewer's tool bars are visible. Value '0'.
- \*YES** The viewer's tool bars are hidden. Value '1'.

### Element 5: Hide menu bar CHAR(1)

- \*NO** The viewer's menu bar is visible. Value '0'.
- \*YES** The viewer's menu bar is hidden. Value '1'.

### Element 6: Hide user interface elements CHAR(1)

- \*NO** The viewer's user interface elements are visible. Value '0'.
- \*YES** The viewer's user interface elements, such as scroll bars and navigation controls, are hidden leaving only the document's contents visible. Value '1'.

### Element 7: Resize window to initial page CHAR(1)

- \*NO** The document's window is not resized. Value '0'.
- \*YES** Resize the document's window to fit the size of the first displayed page. Value '1'.

### Element 8: Center window on screen CHAR(1)

- \*NO** The document's window is not changed. Value '0'.
- \*YES** Position the document's window in the center of the screen. Value '1'.

### Element 9: Display document title CHAR(1)

- \*NO** Display the name of the PDF file containing the document in the window's title bar. Value '0'.
- \*YES** Display the document's title in the window's title bar. Value '1'.

### Element 10: Magnification INT(2)

- \*DEFAULT** Size the page using the viewer's default user setting. Value 0.

<b>*PAGE</b>	Size the page to just fit within the window both horizontally and vertically. Value -1.
<b>*WIDTH</b>	Size the page to just fit within the window horizontally. Value -2.
<b>*HEIGHT</b>	Size the page to just fit within the window vertically. Value -3.
<b>8-1600</b>	Specify the percentage by which the page is magnified.

### Element 11: Page number INT(4)

<b>*DEFAULT</b>	The first page is displayed when the document is opened. Value 0.
<b>*LAST</b>	The last page is displayed when the document is opened. Value -1.
<b>integer</b>	Specify the page number that is displayed when the document is opened.

### PDF media overlay (PDFOVL)

Specifies an overlay to be added to the media (paper) before the contents of the page are rendered. All other content on the page overwrites the content of this overlay. If the spooled file contains an overlay made up of a large image, for example, the contents of this overlay may not be visible. The overlay may not contain other print resources such as page segments. CHAR(8), CHAR(10)

**Note:** This parameter is ignored for transforms except those that generate Adobe's Portable Document Format (PDF).

#### Single values

<b>*NONE</b>	The PDF document does not have a media overlay.
<b>*GREENBAR</b>	An overlay that emulates green bar paper is used.
<b>*BLUEBAR</b>	An overlay that emulates blue bar paper is used.
<b>*COPY</b>	The word "COPY" in large faint letters diagonally across the paper is used.

#### Qualifier 1: PDF media overlay

<b>name</b>	Specify the name of the media overlay to apply.
-------------	---

#### Qualifier 2: Library

<b>*LIBL</b>	All libraries in the thread's library list are searched.
<b>*CURLIB</b>	Use the current library for the job. If no library is specified as the current library for the job, QGPL is used.
<b>name</b>	Specify the name of the library.

### PDF bookmark style (PDFBKMSTY)

Specifies the style of Portable Document Format (PDF) bookmarks generated from the bookmark data. INT(4).

**Note:** This parameter is ignored for transforms except those that generate Adobe's Portable Document Format (PDF).

<b>*ONELEVEL</b>	The name of each bookmark data source becomes a top level bookmark and these are listed in ascending order. Within each top level bookmark, each unique data value is listed, again in ascending order. If a data value appears on more than one page, then within the data value the page numbers are listed in order.
<b>*NONE</b>	No bookmarks are generated.
<b>*TWOLEVEL</b>	In addition to the structure provided by <b>*ONELEVEL</b> cross reference information is also provided. For each top level bookmark/data value, each other top level bookmark/data value that occurs on the same pages is listed within it. For example, if bookmark "SalesRepId" "C775" appears on same pages (254, 321, 467) as "InvoiceNumber" "1009", "1023" and "1102" the follow is generated:

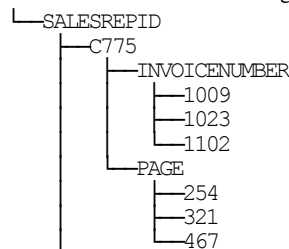

---

## PDF bookmark data source (PDFBKMSRC)

Specifies the data to be used in generating Portable Document Format (PDF) bookmarks.

**Note:** This parameter is ignored for transforms except those that generate Adobe's Portable Document Format (PDF).

Four elements make up a data source specification: line, position, length and name. The most important is line which influences the meaning of the other 3.

### Element 1: Line

- \*DOCIDXTAGP** Bookmarks are generated from the "attribute-name" / "attribute-value" pairs added to the spooled file using the DDS DOCIDXTAG() keyword. Only pairs found at the page level are considered. Pairs at the group level (outside of a page) are ignored.
- Position and length are ignored as data does not appear on the printed page and the length is derived from the data entered.
- If name is omitted, all "attribute-name"s that occur in the spooled file are included, each creating a top level bookmark. If a name is specified, only the "attribute-name" / "attribute-value" pairs with the specified name are included.
- \*DOCIDXTAGG** Processing is identical to that of **\*DOCIDXTAGP** except that only pairs at the group level (outside of a page) are considered and pairs at the page level are ignored. Group level pairs inherit the page number of the next page to occur in the spooled file.
- \*DOCIDXTAG** Processing is identical to that of **\*DOCIDXTAGG** except that all pairs, regardless of level, are considered. Group level pairs inherit the page number of the next page to occur in the spooled file.
- \*STRPAGGRP** Bookmarks are generated from the "group-name"s added to the spooled file using the DDS STRPAGGRP() keyword. The "group-name"s are listed under a single top level bookmark.
- Position and length are ignored as data does not appear on the printed page and the length is derived from the data entered.
- If name is omitted, "Page group" is used as the name of the generated top level bookmark. If a name is specified, it is used as the name of the generated top level bookmark.
- 1-255** Bookmarks are generated from the print information found in the spooled file. Each page is inspected and the data at line/position/length on each is used as the value of a bookmark.
- If name is omitted, "Line xx Position yy Length zz" is used as the name of the generated top level bookmark. The actual values specified are substituted for xx, yy and zz. If a name is specified, it is used as the name of the generated top level bookmark.

### Element 2: Position

- 1-378** Specify the position where the data is located in the line. Valid values range from 1 through 378. The value specified plus the data length should be less than the number of print positions in the spooled file.

### Element 3: Length

- 1-255** Specify the length of the data. The value specified plus the start position should be less than the number of print positions in the spooled file.

### Element 4: Name

- character-value** Specify the bookmark name.

When selecting DBCS data from \*SCS data, the shift out/shift in (SO/SI) characters must be included by the position/length specification.

---

## Fidelity (FIDELITY)

Specifies whether conversion continues when errors are encountered. CHAR(10)

- \*RESOURCE** Conversion stops when print resources referenced by the spooled file are not found.
- \*CONTENT** Conversion continues when errors are found.

---

## Signing key (SGNKEY)

Specifies the digital certificate used to sign the email.

The signature included with the email allows the recipient to validate the identity of the sender and provides additional assurance that the email has not been tampered with after it is signed.

A certificate is referenced by specifying the name (Application ID) of an object signing application created using IBM i's Digital Certificate Manager.

<b>*DEFAULT</b>	The certificate previously entered using the CHGSM1DFT command is used.
<b>*NONE</b>	No signing operation is performed.
<b><i>application-id</i></b>	Specify the application identifier to use in the signing operation.

---

## PDF document signing key (PDFSGNKEY)

Specifies the digital certificate used to sign Portable Document Format (PDF) files.

**Note:** This parameter is ignored for transforms except those that generate Adobe's Portable Document Format (PDF).

The PDF documents produced can be, optionally, digitally signed. The signature included in the PDF document allows the identity of the author to be validated and provides additional assurance that the PDF document has not been tampered with after it was signed.

A certificate is referenced by specifying the name (Application ID) of an object signing application created using IBM i's Digital Certificate Manager.

<b>*DEFAULT</b>	The certificate previously entered using the CHGSM1DFT command is used.
<b>*NONE</b>	No signing operation is performed.
<b><i>application-id</i></b>	Specify the application identifier to use in the signing operation.

---

## Style sheet (HTMCSS)

Specifies the cascading style sheet applied to styled html.

The contents of the stream file are copied, unaltered and uninspected, into the generated html. The contents are placed within a <style></style> tag pair in the head section of the document.

**Note:** This parameter is ignored for transforms except those that generate styled html.

<b>*DEFAULT</b>	The following style sheet is used: <pre>body { background-color: #f7f7f7; } pre {   background-color: #ffffff;   border: 1px solid #f1f1f1;   line-height: 92%;   border-radius: .05em;   box-shadow: 3px 3px 2px #d3d3d3;   padding: .3em .3em .3em .3em; } tr { float: left; } @media print { tr { float: none; page-break-after: always; } }</pre>
<b><i>path-name</i></b>	Specify the stream file to use.

---

## Obsolete (Originator) (USRID)

**Note:** This parameter is obsolete, use the From (originator) (FROM) parameter instead. This parameter remains on the command to protect the upward compatibility of customer programs that used it. If this parameter is specified and the From (originator) (FROM) parameter is not specified, the entered value overrides the default value of the From (originator) (FROM) parameter.

Specifies the network user that originated the email. CHAR(8), CHAR(8)

---

## Examples

### Example 1:

```
SNDSPLMAIL  FILE(QSYSPRT)  TOSMTPNAME(*PAGDTA)
              TRANSFORM(*PDFLETTER)  PAGDTA(*STRPAGGRP)
              JOB(033194/QPGMR/MONTHEND)  SPLNBR(2)
              PDFBKMSRC((5 10 8 Invoice))
```

This command processes spooled file number 2, QSYSPRT from job 033194/QPGMR/MONTHEND. The spooled file is split into separate sections based on the DDS STRPAGGRP/ENDPAGGRP keywords and the sections are each converted to PDF and sent the email address specified on the STRPAGGRP keyword. The spooled file contains invoice numbers printed on line 5, position 10 for a length of 8. These are used to book mark the file for quick access to individual pages.

### Example 2:

```
SNDSPLMAIL  FILE(QSYSPRT)
              TOSMTPNAME(john_smith@widget.com)
              SEND(*TEXTPLAIN)
```

This command sends the last spooled file with name QSYSPRT from the job the job running the command. The spooled file is sent to john\_smith@widget.com. The spooled file is sent in the body of the email.

---

## Error messages

### Parameter dependencies

<b>SM17001</b>	When network user id *GATEWAY is specified an email address must be specified.
<b>SM17002</b>	A network user id or a To (recipient) can be specified, but not both.
<b>SM17003</b>	When To (recipient) *NONE is specified network user id *GATEWAY cannot be specified.
<b>SM17006</b>	At least one recipient is required.
<b>SM17007</b>	When recipient *PAGDTA is specified, parameter PAGDTA() must be specified.
<b>SM17009</b>	An address mapping program is only allowed when the recipient is *PAGDTA.
<b>SM17010</b>	When subject *PAGDTA is specified, parameter PAGDTA() must be specified.
<b>SM17011</b>	When subject *PAGDTA is specified, parameter TOSMTPNAME(*PAGDTA) must be specified.
<b>SM17005</b>	When USRID() is specified FROM() cannot be specified.
<b>SM17004</b>	When send as *TEXTPLAIN is specified transform *TXT or *TXTTRIM must be specified.
<b>SAMD002</b>	When transform *WSCST is specified a Workstation customizing object must be specified.
<b>SAMD003</b>	A transform or a workstation customizing object name can be specified, but not both.
<b>SAMD004</b>	When Workstation customizing object *NONE is specified transform *WSCST cannot be specified.
<b>PDFD001</b>	PDF document security can only be specified with a *PDFxxx transform.
<b>SAMD005</b>	When a style sheet is specified, transform *HTMCSS must be specified.

---

## Verify Local SMTP (VFYLOCAL)

**Where allowed to run:** All environments (\*ALL)

**Threadsafe:** No

The Verify Local SMTP (VFYLOCAL) command verifies or sets up SMTP on the local system.

Details of the verification process are printed with the job's spooled output in file SMLOG.

---

### Parameters

Keyword	Description	Choices	Notes
SETUP	Make changes to system	*NO, *YES, Y, N	Optional, Positional 1

---

### Make changes to system (SETUP)

Specifies the whether the command makes changes to the system.

**\*NO**                    The command does not make changes to the local system.  
**\*YES**                   The command makes changes to the local system.

---

### Examples

#### Example 1:

```
VFYLOCAL    SETUP (*NO)
```

This command verifies that SMTP is set up correctly on the local system.

#### Example 2:

```
VFYLOCAL    SETUP (*YES)
```

This command sets up SMTP on the local system.

---

### Error messages

#### \*ESCAPE messages

**MSU5037**            SMTP verification/set up failed

---

## Verify Mailhub Server (VFYMAILHUB)

**Where allowed to run:** All environments (\*ALL)

**Threadsafe:** No

The Verify Mailhub Server (VFYMAILHUB) command verifies or sets up a forwarding mailhub server for use by the local system.

Details of the verification process are printed with the job's spooled output in file SMLOG.

The command is intended for initial configuration of a system. If a mailhub server and/or host logon information for it have previously been configured, this command cannot be used to modify the system. You can remove a previously configured forwarding mail hub server by running:

```
CHGSMTPA FWDHUBSVR (*NONE)
```

You can remove previously configured host logon information by running:

```
RMVSMTPL TYPE(*HOSTAUTH) HOSTNAME('configured_host_name')
```

---

### Parameters

Keyword	Description	Choices	Notes
<b>RMTSYS</b>	Remote system	Character value, <u>*MAILHUB</u> , *INTNETADR	Optional
<b>INTNETADR</b>	Remote internet address	Character value, <u>*RMTSYS</u> , *MAILHUB	Optional
<b>AUTHUSRNAM</b>	Authentication username	Character value, <u>*NONE</u>	Optional
<b>AUTHPWD</b>	Authentication password	Character value	Optional
<b>SETUP</b>	Make changes to system	*YES, <u>*NO</u> , Y, N	Optional

---

### Remote system (RMTSYS)

Specifies the remote system name of the host with which the Verify Mailhub Server operation takes place. To be successful, the name must be valid, and the remote system must be able to communicate with the local system.

- \*MAILHUB** The name of the configured SMTP forwarding mailhub server is used.
- \*INTNETADR** The INTNETADR parameter is used.
- character-value** Specify the remote system name to use.

---

### Remote internet address (INTNETADR)

Specifies the remote internet address. The internet address is specified in the form **nnn.nnn.nnn.nnn**, where **nnn** is a decimal number ranging from 0 through 255. An internet address is not valid if it has a value of all binary ones or all binary zeros for the network identifier (ID) portion or the host ID portion of the address. If the internet address is entered from a command line, enclose the address in apostrophes.

- \*RMTSYS** The internet address of the specified remote system is used.
- \*MAILHUB** The internet address of the configured SMTP forwarding mailhub server is used.
- character-value** Specify the internet address to use.

---

### Authentication username (AUTHUSRNAM)

Specifies the user name used to authenticate with the remote system. CHAR(80)

Valid characters are case sensitive and include all alpha-numeric characters (a-z, A-Z, and 0-9), and the following special characters: characters: `.,!#$%&*+/-/:;=@?_~^.`

- \*NONE** Authentication is not performed.
- character-value** Specify the user name to send to the remote system for authentication.



---

## Authentication password (AUTHPWD)

Specifies the password used to authenticate with the remote system. CHAR(128)

Valid characters are case sensitive and include all alpha-numeric characters (a-z, A-Z, and 0-9), and the following special characters: characters: `.,!#$%&*+/-/:;=@?_~^.`

**character-value** Specify the password to send to the remote system for authentication.

---

## Make changes to system (SETUP)

Specifies the whether the command makes changes to the system.

**\*NO** The command does not make changes to the local system.  
**\*YES** The command makes changes to the local system.

---

## Examples

### Example 1:

```
VFYMAILHUB RMTSYS (*MAILHUB) SETUP (*NO)
```

Command verifies that the currently configured forwarding mailhub server is set up and operating correctly.

### Example 2:

```
VFYMAILHUB RMTSYS (sys1.widget.com)
            INTNETADR (192.168.1.2) SETUP (*YES)
```

This command sets up sys1.widget.com at address 192.168.1.2 as the forwarding mailhub server for this System i.

---

## Error messages

### Parameter dependencies

**MSU7011** RMTSYS(\*INTNETADR) and INTNETADR(\*RMTSYS) are mutually exclusive.

### \*ESCAPE messages

**MSU5165** Mailhub server verification/set up failed

---

## Verify Mail Router (VFYROUTER)

**Where allowed to run:** All environments (\*ALL)

**Threadsafe:** No

**Note:** THIS COMMAND HAS BEEN SUPERCEDED AND WILL BE REMOVED IN A FUTURE RELEASE. Use Verify Mailhub Server (VFYMAILHUB) instead.

The Verify Mail Router (VFYROUTER) command verifies or sets up a remote mail router for use by the local system.

**Note:** If a mail router has previously been configured, this command cannot be used to change it.

Details of the verification process are printed with the job's spooled output in file SMLOG.

---

### Parameters

Keyword	Description	Choices	Notes
<b>RMTSYS</b>	Remote system	<i>Character value, *ROUTER, *INTNETADR</i>	Optional, Positional 1
<b>INTNETADR</b>	Remote internet address	<i>Character value, *RMTSYS, *ROUTER</i>	Optional, Positional 2
<b>SETUP</b>	Make changes to system	<i>*YES, *NO, Y, N</i>	Optional, Positional 3

---

### Remote system (RMTSYS)

Specifies the remote system name of the host with which the Verify Mail Router operation takes place. To be successful, the name must be valid, and the remote system must be able to communicate with the local system.

- \*ROUTER** The name of the configured SMTP mail router is used.
- \*INTNETADR** The INTNETADR parameter is used.
- character-value** Specify the remote system name to use.

---

### Remote internet address (INTNETADR)

Specifies the remote internet address. The internet address is specified in the form **nnn.nnn.nnn.nnn**, where **nnn** is a decimal number ranging from 0 through 255. An internet address is not valid if it has a value of all binary ones or all binary zeros for the network identifier (ID) portion or the host ID portion of the address. If the internet address is entered from a command line, enclose the address in apostrophes.

- \*RMTSYS** The internet address of the specified remote system is used.
- \*ROUTER** The internet address of the configured SMTP mail router is used.
- character-value** Specify the internet address to use.

---

### Make changes to system (SETUP)

Specifies the whether the command makes changes to the system.

- \*NO** The command does not make changes to the local system.
- \*YES** The command makes changes to the local system.

---

### Examples

#### Example 1:

```
VFYROUTER RMTSYS (*ROUTER) SETUP (*NO)
```

Command verifies that the currently configured mail router is set up and operating correctly.

**Example 2:**

```
VFYROUTER  RMTSYS (sys1.widget.com)
            INTNETADR (192.168.1.2) SETUP (*YES)
```

This command sets up sys1.widget.com at address 192.168.1.2 as the mail router for this System i.

---

**Error messages****Parameter dependencies**

**MSU7011** RMTSYS(\*INTNETADR) and INTNETADR(\*RMTSYS) are mutually exclusive.

**\*ESCAPE messages**

**MSU5139** Mail router verification/set up failed

---

## Work with Gumbo Output Queue (WRKGSIOUQ)

Where allowed to run: All environments (\*ALL)

Threadsafe: No

The Work with Gumbo Output Queue (WRKGSIOUQ) command works like IBM i's Work with Output Queue (WRKOUTQ) command but provides additional options to access the functions of SpoolMail.

---

### Parameters

Keyword	Description	Choices	Notes
OUTQ	Output queue	<i>Qualified object name</i>	Required, Positional 1
	Qualifier 1: Output queue	<i>Name</i>	
	Qualifier 2: Library	<i>Name, *LIBL, *CURLIB</i>	
OUTPUT	Output	<i>*, *PRINT _</i>	Optional, Positional 2

---

### Output queue (OUTQ)

Specifies the name of the Output queue and the library where it resides.

This is a required parameter.

#### Qualifier 1: Output queue

*name* Specify the name of the output queue.

#### Qualifier 2: Library

**\*LIBL** All libraries in the thread's library list are searched.

**\*CURLIB** Use the current library for the job. If no library is specified as the current library for the job, QGPL is used.

*name* Specify the name of the library.

---

### Output (OUTPUT)

Specifies where the output from the command is sent. CHAR(10)

*\_* The output is displayed (if requested by an interactive job) or printed with the job's spooled output (if requested by a batch job).

**\*PRINT** The output is printed with the job's spooled output.

---

### Examples

#### Example 1:

```
WRKGSIOUQ OUTQ (PRT01)
```

This command allows you to work with all of the spooled files on the PRT01 output queue.

#### Example 2:

```
WRKGSIOUQ OUTQ (QGPL/QPRINT)
```

This command allows you to work with all of the spooled files on the QPRINT output queue in library QGPL.

---

### Error messages

#### \*ESCAPE messages

**SUI3002** Command processing failure.

---

## Work with Gumbo Spooled Files (WRKGSISPLF)

Where allowed to run: All environments (\*ALL)

Threadsafe: No

The Work with Gumbo Spooled Files (WRKGSISPLF) command works like IBM i's Work with Spooled Files (WRKSPLF) command but provides additional options to access the functions of SpoolMail.

---

### Parameters

Keyword	Description	Choices	Notes
<b>SELECT</b>	Select files for	<i>Element list</i>	Optional, Positional 1
	Element 1: User	<i>Name, *CURRENT, *ALL</i>	
	Element 2: Print device	<i>Name, *ALL, *OUTQ</i>	
	Element 3: Form type	<i>Character value, *ALL, *STD</i>	
	Element 4: User data	<i>Character value, *ALL</i>	
<b>OUTPUT</b>	Output	<i>_, *PRINT</i>	Optional, Positional 2

---

### Select files for (SELECT)

Specifies the criteria used to further select spooled files for display. Selection criteria consist of 4 elements. Only spooled files that match each of the values are selected.

#### Element 1: User

- \*CURRENT** Spooled files created by the user of the current job are selected.
- \*ALL** All spooled files are selected regardless of the user creating them.
- name** Specify a user name. Only spooled files created by the user are selected.

#### Element 2: Print device

- \*ALL** All spooled files are selected regardless of the device or output queue.
- \*OUTQ** All files on any user-created output queue are selected. A user-created output queue is any output queue that is not automatically created by a device. A user-created output queue does not generally have the same name as a device, but if it does, it does not reside in library QUSRSYS.
- name** Specify a device name. Only files on the device created output queue for that device are selected. A device created output queue is one that has the same name as a device and resides in the QUSRSYS library. Unless it already exists, it will automatically be created by the system when the device is created. A device created output queue cannot be deleted.

#### Element 3: Form type

- \*ALL** All spooled files are selected regardless of their form type.
- \*STD** Only files that specify the standard form type are selected.
- character-value** Specify the form type to select the file.

#### Element 4: User data

- \*ALL** All spooled files are selected regardless of their user data.
  - character-value** Specify the user data to select the file.
- 

### Output (OUTPUT)

Specifies where the output from the command is sent. CHAR(10)

- \_** The output is displayed (if requested by an interactive job) or printed with the job's spooled output (if requested by a batch job).
- \*PRINT** The output is printed with the job's spooled output.

---

## Examples

### Example 1:

```
WRKGSISPLF  SELECT (*ALL *ALL *ALL *ALL)
```

This command allows you to work with all of the spooled files on the system.

### Example 2:

```
WRKGSISPLF  SELECT (CASMITH *ALL *ALL MEMO)
```

This command allows you to work with all of the spooled files on the system for the user named CASMITH that have MEMO specified in the user data for the spooled file.

---

## Error messages

### \*ESCAPE messages

**SUI3002**            Command processing failure.

---

## Chapter 8 Trouble-Shooting

---

### What's In This Chapter

This chapter provides information and procedures useful for correcting or reporting SpoolMail problems. The chapter:

- Describes general trouble-shooting.
- Describes software installation problems.
- Describes general mail delivery problems.
- Describes MSF specific delivery problems.
- Describes SMTP specific delivery problems.
- Describes PDF file problems.
- Describes Gumbo Logical Printer problems.
- Describes RTF file problems.
- Describes how to create a spool save file.
- Describes how to email a spool save file.

---

### General Trouble-Shooting

If a command from SpoolMail fails to run to completion or if the results you receive are different from those expected, perform these items:

- Check the detailed messages in your job log:
  1. Run the DSPJOBLOG command.
  2. Press F10 to display detailed messages.
  3. Locate the messages related to the error.
  4. Place your cursor on each message in turn and press F1.
  5. Take any corrective actions suggested by the messages.
- Download the current cumulative PTF package from [www.gumbo.com](http://www.gumbo.com).
- Check the bottom of the PTF page at [www.gumbo.com](http://www.gumbo.com) for IBM PTFs that may be required.
- Review the detailed trouble shooting procedures in this chapter for solutions related to your problem.

If you are unable to correct the problem, prepare a problem report and contact your service provider.

---

### Software Installation Problems

This section describes problems, causes, and solutions specific to software installation.

- Installation Generates "Directory not registered. (C G)"

<b>Symptom</b>	During installation inquiry message id CPA3DE4 "Directory not registered. (C G)" is issued.
<b>Cause</b>	IBM i has lost the relationship between the product and the directory and hence the message.
<b>Solution</b>	You can safely take a "G" to this message. You will receive the message 3 times.

- Installation Fails

<b>Symptom</b>	Installation fails and diagnostic message id CPF9898 "Unable to clear old release. Is the software being used?" appears in the job log. Or, when the installation verification option is run, verification fails with diagnostic message id CPD0C2E appearing in the job log.
<b>Cause</b>	This usually arises from attempting to install a new release over an old release while objects in the old release are in use.

**Solution** End the jobs that are holding locks on (using) objects from the old release and perform the installation again.

- Installation Fails or Installation Verification Fails

**Symptom** Installation or installation verification fails and messages in the job log do not help in recovering.  
**Cause** The software is not installed correctly or the installation is damaged. This can be caused for a variety of reasons including renaming of libraries, directories, or objects that make up the product.

**Solution** Get the system to a stable consistent state by completely removing the product then re-installing it by performing the following:

1. Delete the licensed program by running:  

```
DLTLICPGM LICPGM(2A55SM1) RLS(*ALL)
          OPTION(*ALL)
```

**Note:** It is okay if this fails with diagnostic CPD3D91 "Product 2A55SM1 option \*ALL release \*ALL not installed."

2. Delete the product's library by running:  

```
DLTLIB LIB(SPOOLMAIL)
```

**Note:** It is okay if this fails with escape CPF2110 "Library SPOOLMAIL not found."

3. Delete the product's directories by running:  

```
RMVDIR DIR('/Gumbo/ProdData/2A55SM1/doc') SUBTREE(*ALL)
RMVDIR DIR('/Gumbo/ProdData/2A55SM1/tmp') SUBTREE(*ALL)
RMVDIR DIR('/Gumbo/ProdData/2A55SM1') SUBTREE(*ALL)
```

**Note:** It is okay if these fail with escape CPFA0A9 "Object not found. ....". But if any of these fail because a directory is not empty, delete the contents using WRKLNK.

If there are no other **GUMBO** products installed:

```
RMVDIR DIR('/Gumbo/ProdData')
RMVDIR DIR('/Gumbo')
```

4. Rebuild IBM i's internal licensed program information by running:  

```
CALL PGM(QSYS/QSZRECOV)
```

**Note:** This takes several minutes depending on machine size.

5. Install the product according to the instructions in the Installation chapter.
6. Enter your authorization code.

---

## General Mail Delivery Problems

This section describes common problems, causes, and solutions for general mail delivery problems. They are listed roughly in the order in which you should proceed. During general mail delivery trouble shooting you should send tests to yourself. Once this works properly, you can move on.

The bulk of the entries in this section are derived from trouble shooting performed by or with customers and in some sense presume that you have an "average" installation. The "average" installation is System i connected to a LAN with the post office (a.k.a. mailhub) on a LAN attached PC running Exchange or Domino, with a connection to the internet at large. At the "average" installation this is the first application to generate email from the System i. Some of the entries in this section may not apply to your situation.

- System Mailhub Configuration Is Unknown

**Symptom** The name of the configured mailhub is unknown.

**Cause** You did not originally configure the system for email delivery.

**Solution** Prompt the CHGSMTPA command and inspect the Forwarding mailhub server (FWDHUBSVR) parameter. If the value is \*NONE, a mailhub is not configured. Otherwise, the name of the mailhub is shown.

- Source Of Problem Is Unknown



**Symptom** The send operation runs to completion but no mail arrives.

**Cause** The problem may be with the mailhub or with IBM i, but the source is unknown.

**Solution** Run PINGMAIL to generate a test message to your email address and directly deliver it to the mailhub by passing IBM i's mail machinery entirely:

**Note:** Substitute the name of your mailhub for the value "mailhub\_server" and substitute your email address for the value "you@domain.com" in the following command.

```
PINGMAIL RMTSYS (mailhub_server)
          SMTPNAME (you@domain.com)
```

If you receive the test message, the mailhub is working correctly and an IBM i issue is indicated. In particular, if the rest of the entries in this section do not correct the problem, you may have a DNS issue.

If you do not receive the test message then there is a problem with the mailhub. You may be able to get an indication of the problem by reviewing the SMTP conversation, which appears in your joblog. Run DSPJOBLOG, press F10 and page back for details.

- IBM i Servers Are Down

**Symptom** The send operation runs to completion but no mail arrives.

**Cause** The IBM i servers responsible for mail delivery may be down, particularly if the System i has been IPLed.

**Solution** Rerun VFYLOCAL to verify that all local servers are up and running:  
VFYLOCAL SETUP (\*NO)

If local verification fails, run:  
VFYLOCAL SETUP (\*YES)

- Mailhub Is Not Processing Mail

**Symptom** The send operation runs to completion but no mail arrives.

**Cause** The mailhub responsible for mail delivery may be down, or not accepting mail from IBM i.

**Solution** Rerun VFYMAILHUB to verify that the mailhub is up and running:  
VFYMAILHUB SETUP (\*NO)

If mailhub verification fails, run:  
VFYMAILHUB SETUP (\*YES)

- Mailhub Refuses Mail with "Funny" Originator Address

**Symptom** The send operation runs to completion but no mail arrives. Or mail arrives for some users but not all users, for example for all but AOL accounts.

**Cause** An email address is not assigned to your directory entry and the mailhub does not like the "funny" address IBM i generates for the originator's address.

**Solution** Assign your email address to your system distribution directory entry: (assume for this example that your "User ID and Address" are "BILLG S1234567" and you "real" email address is "billg@acme.com")

```
CHGDIRE USRID (BILLG S1234567)
        MSFSRVLVL (*SYSMS) PREFADR (*SMTP)
        USRDFNFLD ((SMTPAUSRID SMTP 'billg')
                  (SMTPDMN SMTP 'acme.com'))
```

**Note:** If you are a local Domino for IBM i user substitute MSFSRVLVL(\*DOMINO) for MSFSRVLVL(\*SYSMS).

- SMTP Servers Require Reinitialization

**Symptom** The send operation runs to completion but no mail arrives.

**Cause** IBM i's SMTP servers may need to reinitialize. This is undocumented but our experience and discussions with IBM i's SMTP architect confirm this.

**Solution** Reinitialize IBM i's SMTP servers:  
`INZLOCAL SMTP (*YES) SMTPPURGE (*NO)`  
`MSF (*NO) MSFPURGE (*NO)`

- SMTP Servers Are Clogged With Junk

**Symptom** The send operation runs to completion but no mail arrives.

**Cause** IBM i's SMTP server may contain dead letters or other junk that it cannot deliver. This can be the result of previous attempts to set up mail on the system.

**Solution** Clean out IBM i's SMTP server:

**Note:** Only perform this procedure if you are sure there is no valid deliverable mail in the SMTP server.

**Note:** This procedure should be required at most once per system during initial set up.

`INZLOCAL SMTP (*YES) SMTPPURGE (*YES)`  
`MSF (*YES) MSFPURGE (*YES)`

- Mail Server Framework Is Reporting Errors

**Symptom** The send operation runs to completion but no mail arrives.

**Cause** IBM i's Mail Server Framework jobs may be unable to process mail and are reporting errors.

**Solution** Review job logs for the Mail Server Framework jobs:

1. Work with active jobs by running the following command:  
`WRKACTJOB`
2. Page down to the QSYSWRK subsystem.
3. Locate the job or jobs with the name QMSF and repeat the following steps for each job.
4. Display the job by using option 5 and pressing enter.
5. Display the job log by selecting option 10 and pressing enter.
6. Display detailed messages by pressing F10.
7. You should see a job started (CPF1124) and job submitted (CPI1125) message. If there are no other messages, the Mail Server Framework is not reporting errors. (End of procedure).
8. Display detailed information for each additional message by placing your cursor on the message and pressing F1.
9. Take any corrective action specified in the messages.
10. See the MSF Specific Delivery Problems section of this chapter.

- Mail Server Framework Is Ending Abnormally

**Symptom** The send operation runs to completion but no mail arrives.

**Cause** IBM i's Mail Server Framework jobs may be unable to process mail and are ending abnormally.

**Solution** Review job logs for the Mail Server Framework jobs:

1. Locate job logs for Mail Server Framework jobs that have ended by running the following command:  
`WRKSPLF SELECT(QMSF)`  
 If there are no spooled output files, the Mail Server Framework is not ending abnormally (end of procedure).
2. Page down to the end of the list of spooled files.
3. Display the date and time of the spooled files by pressing F11. If there are no recent spooled files, the Mail Server Framework is not ending abnormally (end of procedure).
4. For each recent job log repeat the following steps:
5. Display the job log by using option 5 and pressing enter.
6. Review the job log for diagnostic and escape messages.
7. Take any corrective action specified in the messages.
8. See the MSF Specific Delivery Problems section of this chapter.

- SMTP Servers Are Reporting Errors

<b>Symptom</b>	The send operation runs to completion but no mail arrives.
<b>Cause</b>	IBM i's SMTP server jobs may be unable to process mail and are reporting errors.
<b>Solution</b>	Review job logs for the SMTP server jobs: <ol style="list-style-type: none"> <li>1. Work with active jobs by running the following command: WRKACTJOB</li> <li>2. Page down to the QSYSWRK subsystem.</li> <li>3. Locate the 4 SMTP server jobs with names that start with QTSMTMP*. Repeat the following steps for each job.</li> <li>4. Display the job by using option 5 and pressing enter.</li> <li>5. Display the job log by selecting option 10 and pressing enter.</li> <li>6. Display detailed messages by pressing F10.</li> <li>7. You should see a job started (CPF1124) and job submitted (CPI1125) message. If there are no other messages, the Mail Server Framework is not reporting errors. (End of procedure).</li> <li>8. Display detailed information for each additional message by placing your cursor on the message and pressing F1.</li> <li>9. Take any corrective action specified in the messages.</li> <li>10. See the SMTP Problems section of this chapter.</li> </ol>

- SMTP Servers Are Ending Abnormally

<b>Symptom</b>	The send operation runs to completion but no mail arrives.
<b>Cause</b>	IBM i's SMTP server jobs may be unable to process mail and are ending abnormally.
<b>Solution</b>	Review job logs for the SMTP server jobs: <ol style="list-style-type: none"> <li>1. Locate job logs for SMTP server jobs that have ended by running the following command: WRKSPFL SELECT(QTCP)</li> </ol> <p>If there are no spooled output files, the SMTP server jobs are not ending abnormally (end of procedure).</p> <ol style="list-style-type: none"> <li>2. Page down to the end of the list of spooled files.</li> <li>3. Display the date and time of the spooled files by pressing F11. If there are no recent spooled files, the SMTP server jobs are not ending abnormally (end of procedure).</li> <li>4. For each recent job log repeat the following steps: <ol style="list-style-type: none"> <li>5. Display the job log by using option 5 and pressing enter.</li> <li>6. Review the job log for diagnostic and escape messages.</li> <li>7. Take any corrective action specified in the messages.</li> <li>8. See the SMTP Problems section of this chapter.</li> </ol> </li> </ol>

---

## MSF Specific Delivery Problems

This section describes problems, causes, and solutions specific to IBM i's Mail Server Framework.

- MSF Job Log Contains QTCPTMM/ATTABOX Messages

<b>Symptom</b>	A QMSF job is complaining about a directory such as QTCPTMM/ATTABOX.
<b>Cause</b>	IBM i's MSF jobs depend on specific directories in the Integrated File System which are added by installing the TCP/IP Utilities and may have been deleted.
<b>Solution</b>	Check the existence of the TCP/IP related directories and reinstall them if they are missing by: <ol style="list-style-type: none"> <li>1. Run the WRKLNK command and locate the QTCPTMM directory.</li> <li>2. Display QTCPTMM's contents using option 5.</li> <li>3. Verify that subdirectories ATTABOX, ENCODE, MAIL, SMTPBOX and TMP exist.</li> <li>4. If directories are missing continue with this procedure otherwise end of procedure.</li> <li>5. Use the DLTLICPGM command to remove the TCP/IP Utilities.</li> <li>6. Use the RSTLICPGM command to reinstall the TCP/IP Utilities.</li> </ol>

- MSF Job Log Contains "System storage threshold exceeded" Message

<b>Symptom</b>	A QMSF job complains that "System storage threshold exceeded".
----------------	--

- Cause** IBM i's MSF jobs stop processing mail when amount of disk space used rises above a set percentage. IBM i ships with this value set to 90%.
- Solution** Either free disk space by deleting unused items or bump the threshold value with this procedure:
1. Run the STRSST command and select option 3 Work with disk units.
  2. Select option 2 Work with disk configuration.
  3. Select option 3 Work with ASP threshold.
  4. Use 1=Select for the appropriate ASP (usually ASP 1).
  5. Press F1=Help to review help for the Change Storage Threshold display.
  6. Change the ASP threshold to 95% or a comfortable value for your installation.

---

## SMTP Specific Delivery Problems

This section describes problems, causes, and solutions specific to IBM i's SMTP servers.

- SMTP Retries Set To Zero

- Symptom** The send operation runs to completion but no mail arrives, or mail arrives for a while then stops until the next IPL.
- Cause** The mailhub is periodically slow or unavailable and IBM i's SMTP attributes for retries are set too low or set to zero.
- Solution** Increase the retry values to give the mailhub more chances at fielding the incoming mail:
1. Prompt the CHGSMTPA command.
  2. Increase the number of retries for the retries by minute parameter.
  3. Increase the number of retries for the retries by day parameter.
  4. Press enter.

- Multiple Garbled Email Messages Arrive

- Symptom** Multiple messages arrive for a send operation and the messages are garbled.
- Cause** IBM i's SMTP is splitting the messages.
- Solution** Turn off message splitting entirely by changing the POP attributes:  
 CHGPOPA      MSGSPLIT (\*NOMAX)

- Time On Mail Is Incorrect

- Symptom** Mail delivers but contains the wrong time.
- Cause** IBM i's QTIMZON system value is not set.
- Solution** See Manual Mail Set Up Steps section of the Set Up chapter for instructions to correct this value. For related information see the *System management > Time management* topic in the IBM i Information Center at <http://publib.boulder.ibm.com/series/>.

---

## PDF File Problems

This section describes problems, causes, and solutions specific to Portable Document Format (PDF) files.

- Pages are blank

- Symptom** The file is generated and displayed without error however the pages displayed are blank.
- Cause** By default, files are compressed as specified in version 1.2 of the PDF specification. This requires Acrobat 3.0 or higher to view correctly.
- Solution** Update your copy of the Acrobat viewer to 3.0 or later or turn off compression by changing the default values for SpoolMail using the CHGSMIDFT command.

- Displayed text is light or missing

- Symptom** The file is generated and displayed without error however the displayed text is light (gray instead of

black) and hard to read, or missing.  
**Cause** By default, Acrobat smoothes text causing it to appear bleached out.  
**Solution** From the Acrobat reader select File > Preferences > General. Deselect the "Smooth Text and Monochrome Images" check box.

- Data truncated when PDF document printed

**Symptom** The file is generated and displayed without error however when it is printed, data is truncated.  
**Cause** The original spooled file's page size may be bigger than the paper size of the selected printer, or may contain print in the printer's unprintable area.  
**Solution** After selecting File > Print, select the "Shrink to Fit" check box before pressing "OK".

- Unable to edit PDF document with Adobe's Acrobat

**Symptom** When attempting to Tools > TouchUp Text, you receive the message: "Touch-Up could not parse this page".  
**Cause** Acrobat is enforcing restrictions on font usage.  
**Solution** Select Help > Acrobat Guide. Review the information found under: Modifying PDF documents; Editing pages and text; Editing text; Revising text for a detailed explanation and work arounds.

- Text Is Reduced and Does Not Fill Page

**Symptom** When viewing the document, the text is small and does not use the entire page.  
**Cause** The printer files PAGESIZE parameter is set incorrectly. Most commonly, the intended page size is 8.5" x 11" but the printer file specifies PAGESIZE(66 132).  
**Solution** Correct the printer file's page size parameter to accurately reflect the intended page size using the CHGPRTF command.

- Overlay Or Data Misaligned On Page

**Symptom** Overlay or print data or both are placed incorrectly with respect to upper left corner of page.  
**Cause** Different printers position print using different algorithms. SpoolMail is not emulating the correct printer.  
**Solution** Use the Reference printer device (REFPRTDEV) parameter of the CHGSMIDFT command to specify the name of the printer that correctly prints the spooled file.

- Overlay And Data Still Misaligned On Page

**Symptom** Overlay is misaligned with respect to print data. The correct Reference printer device has been specified.  
**Cause** SpoolMail needs help determining the processing used by the printer that correctly prints the spooled file.  
**Solution** Run the Display Device Description (DSPDEV) command for the printer. If the "Host print transform" parameter is \*YES, toggle the PDF apply noprtbdr to overlay (PDFNPBOVL) parameter of the CHGSMIDFT command from \*NO (the default value) to \*YES or from \*YES to \*NO.

- Overlay And Data Still Misaligned On Page

**Symptom** Overlay is misaligned with respect to print data. The correct Reference printer device has been specified.  
**Cause** SpoolMail can not determine the printer's no print border from its logical description. Examples of when this situation occurs:

- Some \*SCS printers
- Some \*IPDS printers with AFP(\*NO)
- Ascii printers with custom WSCST specified

**Solution** Enter the printer's no print border values in the Refprtdev offset default (REFOFFSET) parameter of the CHGSMIDFT command.

- Overlay And Data Still Misaligned On Page

**Symptom** Overlay is misaligned with respect to print data. The correct Reference printer device has been specified.

**Cause** There is a discrepancy between the printer's logical description and its actual no print border values. Examples of when this situation occurs:

- Some \*IPDS printers with AFP(\*YES) and no print borders.
- Ascii printers with actual values different from values found in WSCST or MFRTYPMDL parameter

**Solution** Enter the no print border values' discrepancy in the Refprtdev offset correction (REFCORRECT) parameter of the CHGSMIDFT command.

---

## Gumbo Logical Printer Problems

This section describes problems, causes, and solutions specific to Gumbo Logical Printers.

- Spooled Files Go On Hold

**Symptom** The Gumbo Logical Printer is running but it fails to produce results and the spooled files are placed on hold.

**Cause** The printer is encountering an error while processing the spooled files.

**Solution** Display the joblog for the printer writer and correct the error:

**Note:** In this example the printer's name is **GLP01**. Substitute the name of your device in its place.

1. Run WRKJOB JOB(**GLP01**)
2. If the "Select Job" prompt appears, select the job that is active.
3. From the "Work with Job" take option 10 to display the joblog.
4. Press F10.
5. Review the messages for error information.
6. For detailed information, place your cursor on a message and press F1.
7. Correct the errors shown.

- Printer Generates Inquiry Messages

**Symptom** A Gumbo Logical Printer is working correctly but generates operator intervention inquiry messages such as "Load form type \*STD" while processing spooled files.

**Cause** The printer was started with "Message option" \*INQMSG which is the start on the STRPRTWTR command.

**Solution** End and restart the writer specifying "Message option" \*NOMSG.

**Note:** In this example the printer's name is **GLP01**. Substitute the name of your device in its place.

1. End the writer.  
ENDWTR WTR (**GLP01**)
2. Restart the writer specifying \*NOMSG.  
STRPRTWTR DEV(**GLP01**) FORMTYPE (\*ALL \*NOMSG)

The source file SPOOLMAIL/QPDDSRC contains additional information and solutions to product specific problems.

---

## RTF File Problems

This section describes problems, causes, and solutions specific to Rich Text Format (RTF) files.

- Text Is Reduced and Does Not Fill Page

<b>Symptom</b>	When viewing the document, the text is small and doesn't use the entire page.
<b>Cause</b>	The printer files PAGESIZE parameter is set incorrectly. Most commonly, the intended page size is 8.5" x 11" but the printer file specifies PAGESIZE(66 132).
<b>Solution</b>	Correct the printer file's page size parameter to accurately reflect the intended page size using the CHGPRTF command.

---

## Creating a Spool Save File

A save file containing all the information needed to transport and reproduce a spooled file on a **GUMBO** development system can be produced using the Create Spool Save File (CRTSPLSAVF) command. To create a spool save file:

- Determine the identity of the spooled file to be saved. A spooled file's identity consists of the file's name, the name/user/number of the job that created it, and the spooled file's number within the job. You can find this information using option 8 from the Work with Spooled Files (WRKSPLF) or Work with Output Queue (WRKOUTQ) commands among others.
- Determine a library to contain the save file. Typically this is your test library. If you do not have a test library, QGPL can be used.
- Determine a name for the save file. It must be a file name that does not exist in the library determined above.
- Run the Create Spool Save File (CRTSPLSAVF) command entering the information from the preceding steps.

**Note:** The command allows for a short message to be included in the save file. Use this to describe the reason for the save file and to include contact information such as your name and phone number.

In saving the spooled file the command creates a temporary library. It retrieves the contents and attributes of the spooled file and stores these in a user space. Any resources used (such as page segments or overlays) are duplicated to the temporary library. Data areas containing various system values and the message are placed in the library. After creating the requested save file, the library is saved to it and finally the temporary library is deleted.



---

## Emailing A Spool Save File

Once a spool save file has been created using the Create Spool Save File (CRTSPLSAVF) command you can download it to your PC and email it to **GUMBO** by following these steps:

1.  Insure the FTP server is active by running:



```
STRTCPSVR SERVER(*FTP)
```

2.  Choose Start > Programs > Accessories > Command Prompt to open a command prompt (DOS session).
3.  Create a temporary directory and change to it:

```
md c:\gumbo 
cd c:\gumbo 
```

4.  Open an FTP connection to the System i by substituting your system's host name and running:

```
ftp host_name 
```

5.  Enter a user name and password as prompted.
6.  Change to binary (image) mode by running:

```
binary 
```

7. **[PC]** Change to library/file/member mode by running:

```
cd /qsys.lib/qgpl.lib [Enter]  
quote site namefmt 0 [Enter]
```

8. **[PC]** Download the spool save file by running (in this example the save file's name is QGPL/TEST):

```
get qgpl/test [Enter]
```

9. **[PC]** End the ftp session and the command prompt by running:

```
quit [Enter]  
exit [Enter]
```

10. **[PC]** Send email to support@gumbo.com after attaching file c:\gumbo\test.

Include in your email a description of the problem encountered and the command parameter values you were using when it happened.



---

## Appendix A Process Descriptions

---

### What's In This Appendix

This appendix provides detailed descriptions of the processing performed by SpoolMail's mail set up and verification programs. In highly secure environments, it may be against policy to allow third party software to change your system. If this is your situation, you can perform these steps manually. The appendix details:

- Processing Performed During SMTP Verification
- Processing Performed During SMTP Set Up
- Processing Performed During Mailhub Verification
- Processing Performed During Mailhub Set Up

---

### SMTP Verification Process

The following verification steps are performed by the Verify Local SMTP (VFYLOCAL) command when SETUP(\*NO) is specified.

**Note:** No changes are made to your system during verification.

- Verify that TCP Utilities have been installed on the system.

The system is checked to insure that library QTCP exists. If the library is found then the TCP Connectivity Utilities have been installed on the system.

- Verify that the SMTP distribution queues are present.

The system is checked for the existence of QSMTPQ distribution queue.

- Verify that a host and domain name have been configured for the system.
  - If the host name is blank, verification fails.
  - If the domain name is blank, verification fails.
- Verify that the system distribution directory is searchable.

A search is attempted on the system distribution directory.

- Verify that the IBM i Mail Server is active.

The system is checked for an active job with the job name QMSF. If one or more QMSF jobs are active then the Mail Server is active.

- Verify that TCP is active.

The system is checked for an active job with the job name QTCPWRK (before V6 JOB QTCP/IP). If job is active then TCP is active.

- Verify that TCP loopback is operating correctly.

The TCP interfaces are searched to locate the \*LOOPBACK IP address. The \*LOOPBACK interface is started if it is not active and its IP address is PINGed to verify that TCP is operating correctly.

- If the \*LOOPBACK interface is not found, verification fails.
- If the \*LOOPBACK interface is not active and cannot be started, verification fails.
- If the \*LOOPBACK interface cannot be PINGed, verification fails.
- Verify that a TCP interface is defined.

The TCP interfaces are searched to locate one or more IP addresses (excluding \*LOOPBACK).

- If no interfaces are found, verification fails.
- Verify that active TCP interfaces are reachable.

The TCP interfaces are searched to locate one or more IP addresses (excluding \*LOOPBACK). Each interface is contacted (PINGed) to verify the connection.

- If an interface is not active, verification fails.
- If an interface cannot be contacted, verification fails.
- Verify that the SMTP server is active.

The system is checked for an active job with the job name QTSMTPSRVR or QTSMTPSRVD. If either job is active then the SMTP server is active.

- Verify that this host's IP address can be reached by SMTP.
  - Retrieve the host and domain names for this system.

If the host name is blank, verification fails.

- Verify TCP/IP connection to the host name.

If the host is contacted, verification is complete and no further processing is performed.

- Verify TCP/IP connection to the host.domain name.

If the host.domain name cannot be contacted, verification fails.

- Verify that message splitting has been turned off.

The current setting cannot be retrieved so no test is performed and it is assumed that splitting has not been turned off yet.

After all tests are completed, a message summarizing the results is issued.

---

## SMTP Set Up Process

The following set up work is performed by the Verify Local SMTP (VFYLOCAL) command when SETUP(\*YES) is specified.

- If the TCP utilities have not been installed on the system.
  - Manual intervention is required to install the utilities. Automatic set up cannot perform the installation.
- If QSMTPQ distribution queue is not found.
  - Create the distribution queue using the Add Distribution Queue command:

```
ADDSTQ      DSTQ(QSMTPQ) RMTLOCNAME(TCPIPLOC)
            DSTQTYPE(*RPDS)
```

- If a host or domain name have not been configured.
  - Manual intervention is required to configure a host and domain name. Use option 12 (Change local domain and host names) of the Configure TCP/IP (CFGTCP) command. Automatic set up cannot perform the change.

- If the system distribution directory entry cannot be searched.
  - The directory is changed to allow searches using the Change System Directory Attributes command:

```
CHGSYSDIRA  ALWSCH(*YES)
```

- If the IBM i Mail Server is not active.
  - Start the Mail Server using the STRMSF command:

```
STRMSF
```

- If TCP is not active.
  - Start TCP using the STRTCP command:

```
STRTCP
```

- If TCP loopback is not operating correctly.
  - If missing, \*LOOPBACK interface is added using command:

```
ADDTCPIFC  INTNETADR('127.0.0.1') LIND(*LOOPBACK) +
            SUBNETMASK('255.0.0.0') MTU(576)
```

- If loopback PING fails:

Manual intervention is required to correct the problem, which is beyond the scope of set up.

- If no TCP interfaces are found.

Manual operation is required to add an interface using the ADDTCPIFC command.

- If a TCP interface cannot be contacted.

Manual operation is required to correct the problem. If the interface cannot be contacted because it is not active, start the interface using the STRTCPIFC command.

- If the SMTP server is not active.
  - Start the SMTP server using the STRTCPSVR command:

```
STRTCPSVR  SERVER(*SMTP)
```

- If the host's IP address cannot be reached by SMTP.
  - If system is using a remote name server, set up fails.

Manual operation required. Contact the remote name server's administrator to add this system's host name.

- If multiple TCP interfaces are found, set up fails.

Manual operation required. Add this system's name to IBM i's host table using the ADDTCPHTE command.

- If no TCP interfaces are found, set up fails.

Manual operation required. Add a TCP interface using the ADDTCPIFC command.

- An entry is added for this host using the Add TCP Host Table Entry command:

```
ADDTCPHTE  INTNETADR (&INTERNET)  HOSTNAME (( &HOST))  +  
           TEXT('Entry Added By Gumbo Auto TCP/IP +  
           Config')
```

- If message splitting has not been turned off.
  - Message splitting is turned off

The POP attributes are changed:

```
CHGPOPA    MSGSPLIT (*NOMAX)
```

After all steps are completed, a message summarizing the results is issued.

---

## Mailhub Verification Process

The following verification steps are performed by the Verify Mail Router (VFYMAILHUB) command when SETUP(\*NO) is specified.

**Note:** No changes are made to your system during verification.

- Verify that TCP is active.

The system is checked for an active job with the job name QTCPWRK (before V6 JOB QTCPPI). If job is active then TCP is active.

- Resolve system names and internet addresses for command parameters and current mail hub server.
  - Verify domain name server.

If a domain name server is configured, it is tested to insure that it is responding. If it does not respond, verification fails.

- Retrieve currently configured mail hub server name and IP
- Resolve internet address parameter.

If a special value was specified, it is resolved. If it can not be resolved, verification fails.

- Resolve remote system parameter.

If a special value was specified, it is resolved. If it can not be resolved, verification fails.

- Edit the resulting names and IPs for conflicts.
  - Edit remote system and internet address IP.

If the IP of the remote system is different from the internet address, verification fails.

- Edit remote system and internet address names.

If the name of the internet address is different from the remote system name, verification fails.

- Edit current mail hub server and internet address IP.

If the IP of the current mail hub server is different from the internet address, verification fails.

- Verify that the internet address is responding.

The internet address is PINGed to insure that it is reachable and responding. If it is not, verification fails.

- Verify that the internet address is accepting SMTP mail.

The internet address is tested to insure that it is accepting SMTP mail from this System i. If it is not, verification fails.

- Verify that remote system's IP can be resolved.

If an IP cannot be resolved, verification fails.

- Verify that the mail hub server is configured.

If the remote system is not configured as the mail hub server, verification fails.

After all tests are completed, a message summarizing the results is issued.

---

## Mailhub Set Up Process

The following set up work is performed by the Verify Mail Router (VFYMAILHUB) command when SETUP(\*YES) is specified.

- If TCP is not active.
  - Start TCP using the STRTCP command:

```
STRTCP
```

- If a mail hub server is currently configured.

SETUP(\*YES) is suppressed. No changes will be made to the system. VFYMAILHUB will be processed as SETUP(\*NO). To avoid suppression, remove the current mail hub server by running:

```
CHGSMTPA FWDHUBSVR (*NONE)
```

- If an entry currently exists on the SMTP \*HOSTAUTH list for the remote system.

SETUP(\*YES) is suppressed. No changes will be made to the system. VFYMAILHUB will be processed as SETUP(\*NO). To avoid suppression, remove the current SMTP \*HOSTAUTH list entry by running:

```
RMVSMTPLE TYPE(*HOSTAUTH) HOSTNAME('configured_host_name')
```

- If system name and internet address resolution fails.
  - If a domain name server is configured but not responding.

Manual intervention required. Either insure that the configured domain name server is available or remove the domain name server from IBM i's configuration using option 13 of the CFGTCP menu.

- If the internet address parameter cannot be resolved.

Manual intervention required to correct the internet address parameter.

- If the remote system parameter cannot be resolved.

Manual intervention required to correct the remote system parameter.

- Edit the resolved names and IPs for conflicts.
  - If the remote system and internet address IPs are different.

Manual intervention required to correct the parameters.

- If the remote system and internet address names are different.

Manual intervention required to correct the parameters.

- If the current mail hub server and internet address IPs are different.

Manual intervention required. Either correct the parameters or remove the currently configured mail hub server by running the following command:

```
CHGSMTPA FWDHUBSVR (*NONE)
```

- If the internet address is not responding.

Manual intervention required. Either correct the internet address or make the system at that address ready.

- If the internet address is not accepting SMTP mail.

Manual intervention required. Either correct the internet address, or contact the system's administrator and request that the system accept SMTP from IBM i. The words you use to request this differ depending on the software running on the remote system:

- For Microsoft's Exchange Server request that the "Internet Mail Connector" be configured and started. Then request that "SMTP forwarding" be enabled for your system's IP.
- For Lotus' cc:Mail request that the "Link to SMTP" be configured and started.
- For all others request that the "SMTP gateway" be configured and started.
- If the remote system's IP cannot be resolved.

Add an entry using the Add TCP/IP Host Table Entry (ADDTCPHTE) command:

```
ADDTCPHTE  INTNETADR (&INTNETADR)  HOSTNAME ( (&RMTSYS) )  +
           TEXT ('Mailhub added by Gumbo +
                VFYMAILHUB command')
```

- If authentication username and password are included.

Add the authentication information to the SMTP \*HOSTAUTH list:

```
ADDSMTPLE  TYPE (*HOSTAUTH)  HOSTNAME (&RMTSYS)  +
           USERNAME (&AUTHUSRNAM)  PASSWORD (&AUTHPWD)
```

- If the mail hub server is not configured.

Configure the mail hub server using the Change SMTP Attributes (CHGSMTPA) command:

```
CHGSMTPA  FWDHUBSVR (&RMTSYS)
```

After all steps are completed, a message summarizing the results is issued.

---

## Appendix B Record Descriptions

---

### What's In This Appendix

This appendix provides information on SpoolMail files and structures. The appendix:

- Describes the display page data record.

---

### Display Page Data Record

The display page data record PDPAGDRF is in model file SMPAGDD which is used by the Display Page Data (DSPPAGDTA) command to generate output files.

PDPAGDRF is made up of several groups of fields that describe an element of the page.

- Spooled file. These fields provide information about the spooled file from which the data was taken.

<b>PDJSYS</b>	Name of the system where the job that created the spooled file ran.
<b>PDJJOB</b>	Name of the job that created the spooled file.
<b>PDJUSR</b>	Name of the user who produced the spooled file.
<b>PDJNBR</b>	Number of the job in the system.
<b>PDJSPF</b>	Name of the spooled file.
<b>PDJSP#</b>	Spooled file number within the job.

- Location. These fields describe the location of the data in the spooled file.

<b>PDPAGE</b>	Page number.
<b>PDLINE</b>	Line number the data appears on.
<b>-53 = *DOCIDXTAG</b>	The data was added to the spooled file using the DDS DOCIDXTAG() keyword at either the page level or group level.
<b>-54 = *DOCIDXPAG</b>	The data was added to the spooled file using the DDS DOCIDXTAG() keyword at the page level.
<b>-55 = *DOCIDXGRP</b>	The data was added to the spooled file using the DDS DOCIDXTAG() keyword at the group level.
<b>-56 = *STRPAGGRP</b>	The data was added to the spooled file using the DDS STRPAGGRP() keyword.
<b>-57 = *DOCIDXTAGP</b>	The data was added to the spooled file using the DDS DOCIDXTAG() keyword at the page level, group level or was propagated from the group level to all pages in the group.
<b>-58 = *DOCIDXRPP</b>	The data was added to the spooled file using the DDS DOCIDXTAG() keyword at the group level or was propagated from the group level to all pages in the group.
<b>-59 = *STRPAGRPP</b>	The data was added to the spooled file using the DDS STRPAGGRP() keyword or was propagated from the keyword to all pages in the page group.
<b>PDPOS</b>	Position on the line the data starts. When PDLINE contains one of the special values, PDPOS is zero.

- Data. These fields contain the data.

<b>PDVLEN</b>	Length of data contained in the following field.
<b>PDVDTA</b>	Data retrieved from the page. When PDLINE is one of the special values related to the DDS STRPAGGRP() keyword, PDVDTA contains the "group-name" specified. When PDLINE is one of the special values related to the DDS DOCIDXTAG() keyword, PDVDTA contains the "attribute-value" specified.



**PDNLEN**  
**PDNDTA**

Length of data contained in the following field.

Name data. When PDLINE is one of the special values related to the DDS DOCIDXTAG() keyword, PDNDTA contains the "attribute-name" specified otherwise it is blank.

---

## Appendix C Notices

© Copyright Gumbo Software, Inc. 1997, 2012. All Rights Reserved.

Portions of this software are used with permission and:

- Copyright © 1991-2, RSA Data Security, Inc. All rights reserved.
- Copyright © April 29, 1997 Kalle Kaukonen. All Rights Reserved.
- Copyright International Business Machines, Corp. 1991 All Rights Reserved
- Copyright Lexmark International, Inc. 1991 All Rights Reserved
- Copyright © 1990 Adobe Systems Incorporated. All Rights Reserved
- Copyright © 2006 The FreeType Project ([www.freetype.org](http://www.freetype.org)). All rights reserved.
- Are based in part on the work of the Independent JPEG Group.
- Copyright 1994, 1998 The Open Group All Rights Reserved.
- Copyright © 1988, 1989, 1990, 1991, 1992 Sam Leffler
- Copyright © 1991, 1992 Silicon Graphics, Inc.
- Copyright © 1998-2000 Carnegie Mellon University. All rights reserved.
- Copyright © 2002, 2003, 2004 Simon Josefsson
- Copyright © 1998-2006 The OpenSSL Project. All rights reserved.
- Copyright © 1995-1998 Eric Young ([ey@cryptsoft.com](mailto:ey@cryptsoft.com)) All rights reserved.
- Copyright © 1988-1997 Sam Leffler. All rights reserved.
- Copyright © 1995-1998 Jean-loup Gailly
- Copyright © 1995-1998 Mark Adler

For additional information see, file SPOOLMAIL/COPYRIGHT.

---

## Appendix D Order Form

Name \_\_\_\_\_  
Company \_\_\_\_\_  
Address \_\_\_\_\_  
City/State/Zip \_\_\_\_\_  
Country \_\_\_\_\_  
Phone \_\_\_\_\_  
Email \_\_\_\_\_

I have read and agree with the SpoolMail Software License Agreement. I am ordering the following licenses:

System Wide License	-- or --	Partition License		
	Proc.		Prt.	Proc.
-- Serial Number ---	Group	-- Serial Number ---	No.	Count
_____	_____	_____	_____	_____
_____	_____	_____	_____	_____
_____	_____	_____	_____	_____

See the Price List for pricing information. The current Price List is available at [www.gumbo.com](http://www.gumbo.com). License price includes one year of maintenance services. Add the amount shown on the price list for each additional year of maintenance services. In Washington state include sales tax (your local rate or 9.5%).

Licenses . . . . . \_\_\_\_\_  
Maintenance . . . . . \_\_\_\_\_  
In WA state, add sales tax . . . . . \_\_\_\_\_  
Total enclosed . . . . . \_\_\_\_\_  
Signature \_\_\_\_\_ Date \_\_\_\_\_  
Title \_\_\_\_\_

Make checks payable to:

***GUMBO***  
*Software, Inc.*

809 W Howe St  
Seattle, WA 98119  
United States of America  
Phone: 206-284-5078  
Email: [support@gumbo.com](mailto:support@gumbo.com)  
Web: [www.gumbo.com](http://www.gumbo.com)

Rev: 2009/04/14

---

## Appendix E License Agreement

### License

Gumbo Software, Inc. grants to the purchaser, permanent license to use SpoolMail on the specified serial number and processor group IBM System i. For system licenses the grant is specific to the system as a whole. For partition licenses the grant is specific to a partition number (ID) and maximum processing capacity. This license is not transferable and not exclusive.

### Warranty

Gumbo Software, Inc. makes no warranty, either expressed or implied, with respect to SpoolMail, its merchantability or its fitness for any particular purpose. SpoolMail software and documentation are provided on an "AS IS" basis.

### Liability

Gumbo Software, Inc. assumes no responsibility for the use of SpoolMail. Purchaser agrees that Gumbo Software, Inc.'s liability under any circumstances shall not exceed the charges paid by purchaser.

### Updates

Gumbo Software, Inc. may from time to time update SpoolMail to correct defects or add enhancements. Purchaser will receive updates for a period of one year from date of purchase.

Rev: 2001/09/22